

tools

2009-2010 catalog featuring Craftsman



CRAFTSMAN

181-piece Mechanic's Tool Set with Case.

This versatile set features a unique tri-fold case, a locking flex pry bar and innovative Craftsman T-Handle nut drivers.

see page 55 for details.

Sears

SEARS.COM/SHOPTOOLS
800.377.7414

Dear Tool Customer,

It's spring! Time to get working and get some new TOOLS!

Whether you're a construction pro, laborer, or DIY guy, this Tool Catalog is your ultimate resource guide for tools. Take a look at our wide selection, new innovation and best values. And — of course — Craftsman's legendary quality.

SELECTION

We've got you covered with our awesome selection — from the smallest socket to the full-size drill press and everything in-between. You can even create your own ideal tool set with a customized carry case under our exciting new Craftsman Build-A-Set Program.

INNOVATION

We're constantly seeking out unique products and innovations. Look for Ed & Tony's Avatar images and picks throughout the catalog for great items and brands that offer exceptional performance and value.

SATISFACTION

We also welcome your feedback — about our catalog, our products or ways to improve your shopping experience. Just shoot us an email at catalogteam@sears.com

We believe this to be our best assortment ever. Look inside for over 600 NEW & over 1,000 Catalog/Online Exclusive tools from more than 100 brands!

Thanks,

Ed, Tony and Janet, the Tool Catalog Team



THE TOOL CATALOG TEAM

JANET: Senior Creative Manager

ED: Catalog Marketing Manager and Buyer

TONY: Associate Catalog Marketing Manager and Buyer

ONLINE SERVICES

Look for our colorful online service icons throughout the catalog to find out how we can help make your shopping experience better.

- >> Check online for **SALE PRICING!**
- >> **BUY ONLINE PICK-UP IN STORE!**
on eligible items
- >> **MORE TO EXPLORE**
at sears.com!
- >> **SHOP ON THE GO!**
Visit sears2go.com on your mobile device
-  **SEARS.COM/SHOPTOOLS**
Sign up to be notified when items go on sale.

WAYS TO SHOP

ONLINE

Shop online and explore our virtual catalog for even more tools. Navigate, click, explore at sears.com

STORES

Want to feel what you're buying before you pay for it? Check out your items in a store, first! Go to sears.com/storelocator

MOBILE

Shop by cell phone! Get the new shopping download at sears2go.com

PHONE

Call us! (800) 377-7414 to place your order or get more information.

Need it now? Buy online or by phone and pickup in store!
PICK-UP IN STORE
on eligible items

SEARS SERVICES

INSTALLATION

Get prompt and professional installation of your new items. We'll even show you how to use them. (888) 546-4096

PARTS DIRECT

Find parts & accessories for all major brands. searspartsdirect.com or (800) 252-1698

PRICE DROP ALERT

Be the first to know it's on sale! Download our free price drop alert widget.

SERVICE LIVE

Save time and money on hassle-free home/office repairs and improvements with ServiceLive.com Find the best service providers in your area.

MANAGE MY HOME

The smarter way to get things done. Turn your ideas into reality! We provide powerful tools and expert advice to get even your toughest home projects done right! Go to managemyhome.com

SAY HELLO TO... ED & TONY

We're the Sears Tool Catalog Guys!

Look for our **TOP TOOL PICKS** throughout the catalog for standout **PERFORMANCE** and exceptional **VALUE**.

Take it from us, this stuff is **AWESOME!**

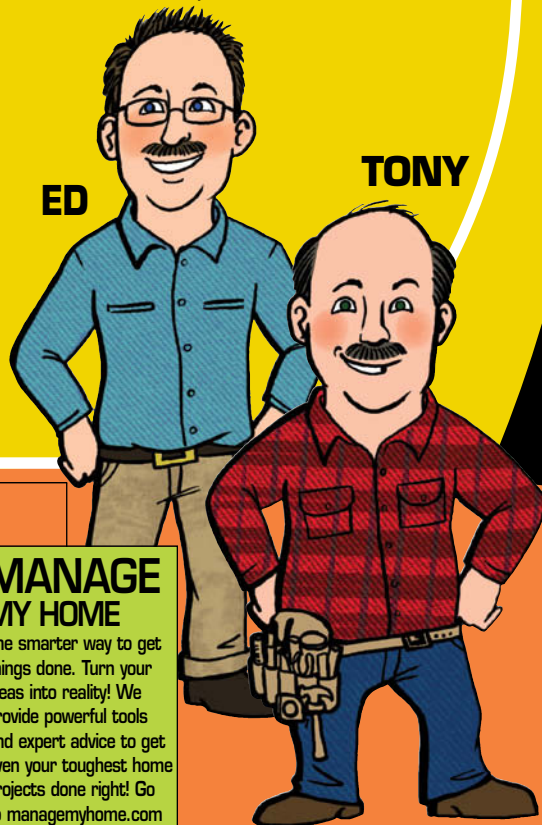

tools

YOUR SOURCE CATALOG OF
RENOWNED BRANDS
AND AMERICA'S #1 RATED
BRAND FOR OVERALL
QUALITY... CRAFTSMAN

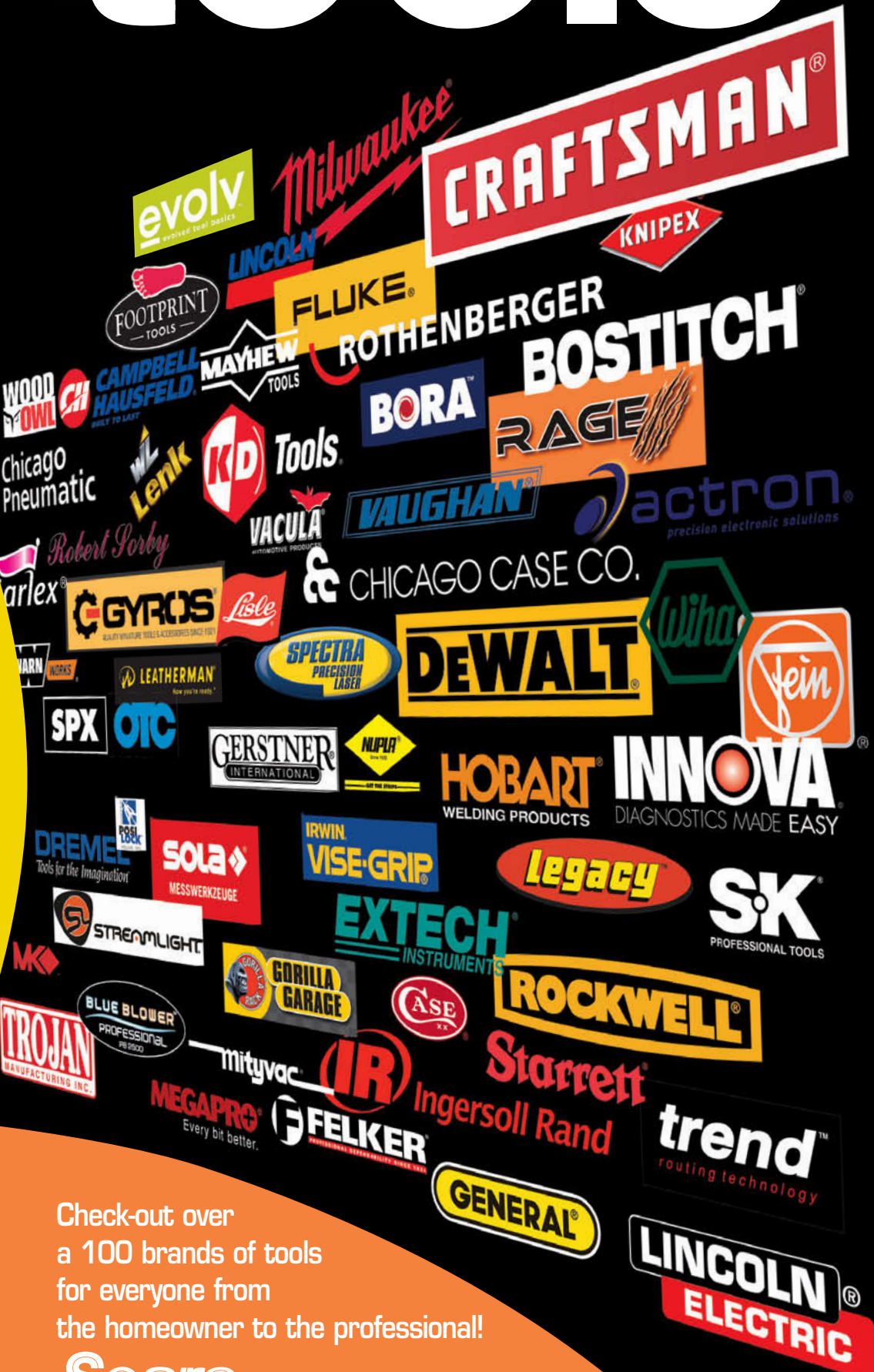

table of contents

Tool Storage	ball-bearing, carts, garage, homeowner, industrial, workbenches	4-31
Mechanic's Tools	sets, sockets, wrenches, ratchets, drive tools, collectibles, personalized	32-75
Automotive Specialty	creepers, diagnostic, thermal imaging, inverters, lifts, specialty tap & die, hand tools	76- 86
General Purpose Tools	screwdrivers, pliers, punches, chisels, pry bars, adjustable wrenches, pull saws snips, multi tools	87- 97
Electrical	flashlights, insulated tools, meters, shop/work lights	98-100
Plumbing	drain cleaners, hand tools, cordless band saws	101, 185
Woodworking	hammers, knives, levels, measuring tools, sharpening tools, wood burning tools, pull saws, soft storage, staplers	102-109
Compressors and Air Tools	compressors & accessories, angle/die-grinders, drills, grease/lubrication, hammers, hoses & hose reels, impact ratchets & wrenches, rivet guns, sanders, saws, impact sockets & socket sets	110-135
Garage Solutions	garage door openers, winches, pressure washers, specialty storage	136-139
Welding	Cutting outfits, fume extraction, helmets, plasma cutters, welders & accessories, welding apparel, welding tools	140-147
Carpentry Air Tools	Compressors, flooring tools, gloves, nailers/staplers & accessories	148-151
Bench Power Tools	accessories, band saws, drill presses, dust and fume extraction, grinders and buffers, jointers, lathes, miter saws, planers, sanders, table saws, tile cutting, work stands	152-171
Workshop Solutions	wet/dry vacs, ladders, paint and ladder accessories, safety, sharpeners, rollers and stands, sawhorses, shop fans	172-177
Portable Power Tools	accessories, buffer/polishers, circular saws, drills, grinders, lithium-ion tools, combos, reciprocating saws, routers, router tables, sabre saws, sanders, rotary	178-195
Customer Service Information and Index	ordering information, index	94A, 94B

Check-out over
a 100 brands of tools
for everyone from
the homeowner to the professional!

Sears

NEW CRAFTSMAN® STORAGE

Craftsman Garage Storage

A. NEW Craftsman Wall Cabinet	B. NEW Craftsman Floor Cabinet	C. NEW Craftsman Workbench	D. NEW Craftsman 5-Drawer Workbench Module	E. Craftsman 2-Shelf Plastic Utility Cart
28W x 12D x 28H in.	32W x 18D x 72H in.	72W x 24D x 41 1/4H in.	29 1/2W x 18D	34 1/2W x 17 1/2D x 32 1/2H in. (Sm.), 40 1/2W x 25 3/4D x 32 1/2H in. (Lg.)
FEATURES:				
1 Shelf Accepts magnetic graphic panels Hole for power cords Mounts directly to VersaTrack™, drywall or wall studs Door latching system Assembly required	3 Shelves Accepts magnetic graphic panels Large leveling feet Hole for power cords Door latching system Assembly required	Large leveling feet Full-width backplash 1-inch coated fiberboard top with banded edges Accepts 1 or 2 5-drawer modules Assembly required	5 Drawers Ball-bearing drawer slides Must be used with workbench "C" Can be mounted under either side Includes drawers, slides and one support leg Drawer depth 16 1/2-in. Assembly required	2 Shelves Heavy-duty material Molded-in side handle 5x2 inch casters (two fixed, two swivel) 300 lb. load rating - Small 400 lb. load rating - Large Assembly required
009-10131N◆ Red/Black 009-10135N◆ Black/Platinum Wt. 45 lbs.	009-10134N◆ Red/Black 009-10140N◆ Black/Platinum Wt. 126 lbs.	009-10132N◆ Red/Black 009-10138N◆ Black/Platinum Wt. 100 lbs.	009-10133N◆ Red/Black 009-10139N◆ Black/Platinum Wt. 63 lbs.	009-59732 Small 009-59733 Large Wt. 38 lbs. (Sm.) 48 lbs. (Lg.)
\$149.99	279.99	219.99	199.99	99.99 (Sm.) 169.99 (Lg.)

Craftsman introduces a new line of next level. Large pieces and all-steel. The result - a great-looking, organized

C and D. NEW-SAVE \$50 Workbench and 5-Drawer Module. See chart for details. Buy both and save. Separate prices total \$419.98. Wt. 163 lbs.
009-93222N◆ Red/Black
009-93223N◆ Black/Platinum 369.98

F and G. NEW-SAVE \$100 10-Drawer Combo. Ball-bearing drawer slides support 50 lbs. per drawer. Features exclusive I-Frame® construction and internal locking system. Separate prices total \$449.98. Wt. 168 lbs.
009-94673N◆ Red/Black
009-61889N◆ Black/Platinum 349.98

EXPLORE THE GARAGE OF KNOWLEDGE...AT CRAFTSMAN



WALL AND FLOOR CABINET DOORS ARE SOLID BLACK. ITEMS A THROUGH D

... MAXIMIZE THE POSSIBILITIES

garage storage that takes your garage to the construction maximize storage possibilities. ed and spacious garage you will be proud of!

F. NEW 6-Drawer Chest. Top center locking security drawer. Measures 26W x 12D x 15 3/8H in. Wt. 65 lbs.
009-62020 Red/Black
009-59298 Black/Platinum169.99

G. NEW 4-Drawer Roll-Away. 4 1/2 x 1 1/2-inch casters provide a 600 lb. load rating. Measures 26 1/2W x 18D x 34 1/4H in. Wt. 103 lbs.
009-62021N♦ Red/Black
009-59299N♦ Black/Platinum279.99

1-4. NEW Craftsman Pit Crew Chief Magnetic Graphic Panels. Product details can be found in the green box to the right on page 7.

CRAFTSMAN.COM/GARAGEOFKNOWLEDGE



Now you can create a versatile, custom storage solution without breaking the bank!

ED'S PICK



ALSO AVAILABLE IN BLACK/PLATINUM

EXPLORE THE GARAGE

Navigate through rooms of power tools, hand tools and yard equipment. Interact with the featured tool wall display, checkout the Craftsman Club and NASCAR bulletin boards or view videos on the flat screen. Plus... watch what happens in the sky and who visits... you just never know who might stop by the Garage of Knowledge!



- SEE THE LATEST INNOVATIVE TOOLS
- VIEW HOW TO SEGMENTS
- LISTEN TO TESTIMONIALS
- GET IDEAS FOR SHOPPING SMART
- READ TOOL BLOGS AND TIPS

CRAFTSMAN.COM/GARAGEOFKNOWLEDGE



versatrack™

VersaTrack™ grooves can hold wood or metal pegboard away from a wall. HOOKTITE™ accessories include a pegboard adaptor.



VersaTrack™ tracks can stack together to cover a wall.

NEW! Craftsman VersaTrack™ and HOOKTITE™ Accessories – A winning Combination!

HOOKTITE™ ACCESSORIES HOLD UP TO 50 LBS.

Craftsman VersaTrack™ Trackwall. Build the wall storage system that fits your needs and budget with this innovative, versatile system. Interlocking tracks install easily on drywall, studs and masonry. Cover an entire wall, install single strips, or use with pegboard. VersaTrack® holds HOOKTITE™ accessories, as well as the Craftsman garage storage wall cabinet "A".

R. NEW VersaTrack™. Measures 48 x 5 1/2 in. Easy to install. Uses two #10(5 mm) flathead screws (not included). Wt. 3 lbs. **009-10124** **9.99**

Also Available NEW VersaTrack™ End Caps. Includes four end caps for finished look. Wt. 1.6 lbs. **009-10128** **9.99**

NEW VersaTrack™ Joiners. Includes four joiners for seamless end-to-end connection. Wt. 1 lb. **009-10125** **9.99**

HOOKTITE™

Hooktite™ Accessories

Description	Width	Uses	Item #	Price
H. NEW! Large Hook	7 3/4 in.	Extension cords, Garden hoses, Ladders	009-10102	\$9.99
J. NEW! Curved Pivot Hook	3 5/8 in.	Long-handled Items	009-10108	5.99
K. NEW! Standard Double Hook	3 1/2 in.	Trimmers, Leaf blowers, Rakes, Axes	009-10117	7.99
L. NEW! Short General Purpose Hook	3 1/2 in.	Lawn equipment, Step stools, Lawn chairs	009-10118	6.99
M. NEW! Long General Purpose Hook	4 in.	Garden equipment, Bicycles, Leaf blowers, Strollers	009-10119	7.99
N. NEW! Outdoor Power Tool Hook	5 in.	Leaf blowers, Hedge trimmers, Lawn trimmers	009-10129	13.99
P. NEW! Narrow Basket	11 in.	Aerosol cans, Bottles, Spools, Gloves	009-10100	12.99



NEW! Magnetic graphic panels... Customize the look of your Craftsman garage.

See more than 100 designs ranging from alma maters to U.S. Army

The Craftsman Pit Crew Chief design is shown in the photo to the left.

Catalog/Online EXCLUSIVE

NEW Magnetic Graphic Panels for Craftsman Garage Storage. Transform your Craftsman garage storage system into a cool, customized environment. High-resolution images are printed on flexible magnetic material, UV-stabilized to prevent discoloration and laminated for easy cleaning. Wall cabinet panels are 8 3/8W x 22 5/16H in. Floor cabinet panels are 10 3/8W x 66 5/16H in. See more than 100 additional designs, including colleges and military branches, at sears.com/shoptools.

- 1 – 4 Wall and Floor Cabinet (4-pc.) SAVE \$13**
009-87728 Craftsman Skeleton **79.98**
009-87727 Craftsman Pit Crew Chief **79.98**
- 1 – 2 Floor Cabinet (2-pc.)**
009-88112 Craftsman Skeleton **67.99**
009-88110 Craftsman Pit Crew Chief **67.99**
- 3 – 4 Wall Cabinet (2-pc.)**
009-88111 Craftsman Skeleton **24.99**
009-88109 Craftsman Pit Crew Chief **24.99**

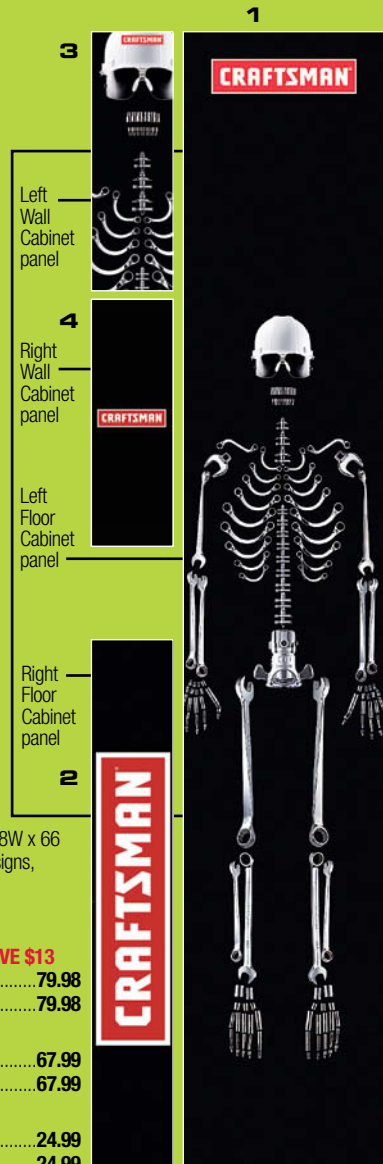

◆ See "N" suffix note on page 41.

introduced by

CRAFTSMAN

evolv™

evolved tool basics

easy on the wallet
everyday use
ergo comfort grip

ALL NEW

Sometimes, life breaks. It comes unscrewed, pulled out, torn up, and run down. No worries. Just reach for your evolv tools. evolv doesn't make expensive tools—just practical ones. Tools that are simple and comfortable. Tools that simply get the job done. Because at the end of the day, isn't that all you ask of your tools?

REAL. SIMPLE. TOOLS.



24-PC HOMEOWNER SET

B extendable ratchet



C teardrop ratchet



COMFORT-GRIP HANDLED
RATCHETS AND MORE
INNOVATIONS FROM EVOLV

A. 24-piece Homeowner Set with Tote. Features a multiple pocket bag with a project parts tray and ergo-grip tools for comfort. 5 precision screwdrivers (1/16", 3/32", 1/8", #00, #0 x 2 1/2-in.), 13 oz. fiberglass hammer, 8-in. slip joint and 6-in. long nose pliers, 6-in. adjustable wrench, 16" x 3/4" tape measure, utility knife, bit driver, 10 screwdriver bits. Wt. 8.5 lbs. **009-10202****39.99**

B. Evolv 3/8-Inch Drive Extendable Ratchet. Locks in 4 lengths between 8.5 and 12.5 inches. Teardrop quick release head design. Wt. 1.1 lbs. **009-10033****19.99**

C. Evolv Teardrop Ratchets. Durable teardrop design fits in tight spaces while the quick-release head makes size changes easy. **009-10030** 1/4-in. drive. Wt. 0.4 lb.**12.99**

009-10031 3/8-inch drive. Wt. 0.7 lb.**14.99**

009-10032 1/2-inch drive. Wt. 1.4 lbs**19.99**

D. Evolv 3/8-Inch Drive Speeder Ratchet. Handle rotates and extends to a crank position for more speed. Wt. 1.2 lbs. **009-10203****19.99**

FIND OUT MORE ABOUT
go to www.evolvtools.com



D speeder ratchet



18-PC SET

E. 18-piece Utility Set. The perfect household set, with ergo grips for comfort. Includes: 6-in. long nose, diagonal and slip joint, 7-in. linesman and 8-in. groove joint pliers; 3 adjustable wrenches (6, 8, and 10-in.); 10 screwdrivers, 5 slotted and 5 Phillips. Wt. 7.61 lbs. **009-93314****39.97**

F. 14-piece Inch/Metric Full Polish Combination Wrench Set. Full polish for easy cleanup. Great in tight spaces. Set includes 7 inch (1/4 thru 5/8-in.) and 7 metric (8, 10, 11 thru 15 mm). Wt. 2.6 lbs. **009-10055****19.99**



E

14-PC SET



F

CRAFTSMAN®

PROFESSIONAL

BIGGER, BOLDER

SIX COLORS TO CHOOSE FROM! ... PLATINUM/BLACK,



Master Lock® One-Key™ locking system lets you key top and bottom units alike.

Master Lock

ALL NEW

A
75-INCH

B
94-INCH

C

D

All units feature 6-inch x 2-inch casters with heavy-duty toe brakes

A. NEW Craftsman 75-inch Wide Canopy	B. NEW Craftsman 94-inch Wide Cart	C. NEW Craftsman 56-inch Wide Canopy	D. NEW Craftsman 56-inch Wide Cart	E. NEW Craftsman 24-inch Deep Side Cabinet	F. NEW Craftsman 56-inch Wide Top Chest	G. NEW Craftsman 75-inch Wide Cart
75W x 30D x 24 1/2H in.	94W x 30D x 43 3/4H in.	56W x 24D x 24 1/2H in.	56W x 24D x 42 3/4H in.	19 1/4W x 24D x 35 3/4H in.	56W x 24D x 25 3/8H in.	75W x 30D x 42 3/4H in.
52,488 cu. in. of storage	48,535 cu. in. of storage	26,872 cu. in. of storage	28,033 cu. in. of storage	8,588 cu. in. of storage	18,288 cu. in. of storage	39,263 cu. in. of storage
	20 DRAWERS		13 DRAWERS	6 DRAWERS	10 DRAWERS	14 DRAWERS
FEATURES:						
Work light and 6-outlet power strip Gas struts	1-in. thick vinyl-coated MDF worksurface 8 spring-loaded casters	Work light 6-outlet power strip Gas struts	1 in. thick vinyl-coated MDF worksurface 6 x 2-inch casters Full-width top drawer	Mounts to either side of any 37-in. or 56-in. wide Craftsman Professional Cart	Gas struts in lid	6 spring-loaded casters
009-82442N ♦ Red 009-82445N ♦ Black 009-82448N ♦ Blue 009-82451N ♦ Platinum/Black 009-82454N ♦ Yellow 009-82457N ♦ Electric Blue	009-82458N ♦ Red 009-82459N ♦ Black 009-82460N ♦ Blue 009-82461N ♦ Platinum/Black 009-82462N ♦ Yellow 009-82463N ♦ Electric Blue	009-82424N ♦ Red 009-82427N ♦ Black 009-82430N ♦ Blue 009-82433N ♦ Platinum/Black 009-82436N ♦ Yellow 009-82439N ♦ Electric Blue	009-82423N ♦ Red 009-82426N ♦ Black 009-82429N ♦ Blue 009-82432N ♦ Platinum/Black 009-82435N ♦ Yellow 009-82438N ♦ Electric Blue	009-82476N ♦ Red 009-82478N ♦ Black 009-82480N ♦ Blue 009-82483N ♦ Platinum/Black 009-82485N ♦ Yellow 009-82487N ♦ Electric Blue	009-82422N ♦ Red 009-82425N ♦ Black 009-82428N ♦ Blue 009-82431N ♦ Platinum/Black 009-82434N ♦ Yellow 009-82437N ♦ Electric Blue	009-82441N ♦ Red 009-82444N ♦ Black 009-82447N ♦ Blue 009-82450N ♦ Platinum/Black 009-82453N ♦ Yellow 009-82456N ♦ Electric Blue
Wt. 245 lbs.	Wt. 1,380 lbs.	Wt. 150 lbs.	Wt. 600 lbs.	Wt. 212 lbs.	Wt. 425 lbs.	Wt. 1,110 lbs.
\$1,999.99	8,999.99	1,499.99	4,499.99	1,399.99	2,499.99	8,999.99

PROFESSIONAL TOOL STORAGE



TRAFFIC YELLOW, MIDNIGHT BLUE, RED, BLACK, ELECTRIC BLUE

INDUSTRIAL STORAGE

56 INCH
CART WITH
CHEST OPTION



PRICING INCLUDES

FREIGHT AND PREMIUM
DELIVERY SERVICE*

FEATURES

- Double roll cage construction with heavy gauge reinforcement
- GRIPLATCH® drawer retention system
- Master Lock® and One-Key™ locking system
- 6 x 2 in. zinc-plated casters with heavy-duty toe brakes

ALL-NEW Craftsman Professional tool storage stands up to the tough requirements of the professional work environment. This new series features internal roll-cage construction, heavy-duty ball-bearing slides, 6"x2" upgraded casters and chrome-plated handles for efficient mobility, even under loaded conditions. Vinyl-coated MDF work surface and premium drawer liners complete the new style.



56-INCH



75-INCH

Completely redesigned for professional mechanics with ultra heavy duty construction.

ED'S PICK



37-INCH

H

J

K

SIDE LOCKER

H. NEW Craftsman 5-Foot Tall Side Locker	J. NEW Craftsman 37-inch Wide Top Chest	K. NEW Craftsman 37-inch Wide Cart
19 1/4W x 24D x 60H in.	37W x 24D x 42 1/2H in.	37W x 24D x 42 3/4H in.
27,497 cu. in. of storage	9,053 cu. in. of storage	16,237 cu. in. of storage
3 DRAWERS	5 DRAWERS	8 DRAWERS
FEATURES:		
Mounts to either side of any 37-in. or 56-in. wide Craftsman Professional Combo Three 2 1/2-inch tall drawers	Gas struts in lid	1 in. thick vinyl-coated MDF work surface 6 x 2-inch casters
009-82464N◆ Red 009-82466N◆ Black 009-82468N◆ Blue 009-82470N◆ Platinum/Black 009-82472N◆ Yellow 009-82474N◆ Electric Blue	009-82410N◆ Red 009-82412N◆ Black 009-82414N◆ Blue 009-82416N◆ Platinum/Black 009-82418N◆ Yellow 009-82420N◆ Electric Blue	009-82411N◆ Red 009-82413N◆ Black 009-82415N◆ Blue 009-82417N◆ Platinum/Black 009-82419N◆ Yellow 009-82421N◆ Electric Blue
Wt. 225 lbs.	Wt. 240 lbs.	Wt. 355 lbs.
1,499.99	1,999.99	2,999.99

*See "N" suffix note on page 94a.

DEFINE YOUR STYLE... CUSTOMIZE IT!

at craftsman.com/AXS

Bring inspiration into your home or garage with a custom-built Craftsman AXS Storage Combo. The Build Your AXS Program offers a variety of paint colors and finishes to help define your AXS style.

Personalized to your look and style, these custom-built AXS Combos have all the same great features of AXS A and B: an electronics package that features a multi-functional message center, 12-volt power outlet, 6-outlet power strip and task lighting; stacked I-Frame® design; Master Lock® One-Key® learning lock system; ball-bearing drawer slides and much more! Build Your AXS @ craftsman.com/AXS starting at \$1,399.98.

Catalog/Online EXCLUSIVE

A and B. SAVE \$200 AND GET FREE DRAWER LINERS

13-Drawer Combo. Provides 14,650 cu. in. of storage.

Separate prices total \$1,199.98 to \$1,249.98. Wt. 263 lbs.
009-93225N◆ - Black Pearl **999.98**
009-93226N◆ - Midnight Blue **999.98**
009-93224N◆ - Titanium Metallic **999.98**
009-93227N◆ - Racer Red **1,049.98**

A. Craftsman AXS 6-Drawer Chest. Provides 4,650 cu. in. of storage. Measures 27W x 18D x 24 1/5H in. Wt. 98 lbs.

009-95166N◆ - Black Pearl **539.99**
009-95436N◆ - Midnight Blue **539.99**
009-59668N◆ - Titanium Metallic **539.99**
009-95434N◆ - Racer Red **559.99**

B. Craftsman AXS 7-Drawer Roll-Away. Provides 10,000 cu. in. of storage. Measures 27W x 21D x 42 1/4H in. Wt. 160 lbs.

009-95167N◆ - Black Pearl **659.99**
009-95437N◆ - Midnight Blue **659.99**
009-59669N◆ - Titanium Metallic **659.99**
009-95435N◆ - Racer Red **689.99**

AXS	CUSTOM ACCESSORIES FUNCTIONAL DESIGN
-----	--------------------------------------

C. Drawer Label Set. 30 silver/black magnetic drawer labels feature names of tools and supplies. Wt. 0.3 lb.

009-95442 **19.99**

D. Roll-Away Accent Light. Neon light delivers a cool, blue glow when mounted under an AXS roll-away. Wt. 1 lb.

009-95444 **34.99**

Custom Cut Drawer Liners. High tack, non-slip silver liners with Craftsman embossed custom cut to fit AXS chest or roll-away. Wt. 2.5 lbs.

009-95455
 6 Chest Liners **29.99**
009-95456
 7 Roll-Away Liners **29.99**



SAVE \$200 ... PLUS GET FREE DRAWER LINERS WHEN YOU PURCHASE ANY FEATURED AXS™ COMBO



LEADING-EDGE DESIGN IN ORGANIZATION, FUNCTION AND APPEARANCE. AXS™ IS LOADED WITH FEATURES!



task lighting
 stacked I-Frame® design
 75 lb. drawer load capacity
 heavy-duty slide out worksurface
 Master Lock® One-Key™ lock system
 6-outlet power strip
 full-extension ball-bearing slides
 1,200 lb. total load capacity
 stylized casters

MORE TO EXPLORE
 >> at sears.com!

Note: Roll-Away Accent Light sold separately.



AVAILABLE IN
CLASSIC OR
DIAMOND FINISH

E and F. NEW SAVE \$300 52-Inch Wide 23-Drawer Combo. 33,170 cu. in. of storage. Separate prices total \$2,099.98. Wt. 454 lbs.
009-93231N ♦ - Classic **1,799.98**
009-93283N ♦ - Diamond **1,799.98**

E. NEW 52-Inch Wide 9-Drawer Chest. 12,218 cu. in. of storage. Measures 52W x 16D x 19 3/4H in. Wt. 161 lbs.
009-82493N ♦ - Classic **849.99**
009-82896N ♦ - Diamond **849.99**

F. NEW 52-Inch Wide 14-Drawer Cart. 20,952 cu. in. of storage. Measures 52W x 18D x 41 1/2H in. Wt. 293 lbs.
009-82494N ♦ - Classic **1,249.99**
009-82897N ♦ - Diamond **1,249.99**

G and H. NEW SAVE \$100 41-Inch Wide 16-Drawer Combo. 26,879 cu. in. of storage. Separate prices total \$1,299.98. Wt. 341 lbs.
009-93230N ♦ - Classic **1,199.98**
009-93282N ♦ - Diamond **1,199.98**

G. NEW 41-Inch Wide 5-Drawer Chest. 11,017 cu. in. of storage. Measures 41W x 18D x 20H in. Wt. 129 lbs.
009-10595N ♦ - Classic **549.99**
009-82894N ♦ - Diamond **549.99**

H. NEW 41-Inch Wide 11-Drawer Cart. 15,862 cu. in. of storage. Measures 41W x 18D x 39 1/4H in. Wt. 212 lbs.
009-10600N ♦ - Classic **749.99**
009-82895N ♦ - Diamond **749.99**

Clear coat protection reduces fingerprints, cleans easily with soap and water, and aids against corrosion



J and K. NEW SAVE \$100 27-Inch Wide 11-Drawer Combo. 14,491 cu. in. of storage. Separate prices total \$849.98. Wt. 212 lbs.
009-93228N ♦ - Classic **749.98**
009-93280N ♦ - Diamond **749.98**

J. NEW 27-Inch Wide 5-Drawer Chest. 6,116 cu. in. of storage. Measures 26 7/8W x 16D x 19 3/4H in. Wt. 89 lbs.
009-82489N ♦ - Classic **349.99**
009-82890N ♦ - Diamond **349.99**

K. NEW 27-Inch Wide 6-Drawer Roll-Away. 8,375 cu. in. of storage. Measures 26 7/8W x 18D x 35H in. Wt. 123 lbs.
009-82490N ♦ - Classic **499.99**
009-82891N ♦ - Diamond **499.99**

L and M. NEW SAVE \$100 27-Inch Wide 14-Drawer Combo. 17,489 cu. in. of storage. Separate prices total \$999.98. Wt. 222 lbs.
009-93229N ♦ - Classic **899.98**
009-93281N ♦ - Diamond **899.98**

L. NEW 27-Inch Wide 6-Drawer Chest. 6,826 cu. in. of storage. Measures 26 7/8W x 18D x 19 3/4H in. Wt. 86 lbs.
009-82491N ♦ - Classic **399.99**
009-82892N ♦ - Diamond **399.99**

M. NEW 27-Inch Wide 8-Drawer Roll-Away. 10,663 cu. in. of storage. Measures 26 7/8W x 18D x 41 1/4H in. Wt. 136 lbs.
009-82492N ♦ - Classic **599.99**
009-82893N ♦ - Diamond **599.99**

FOR DRAWER SIZES GO TO
SEARS.COM/SHOPTOOLS

STAINLESS STEEL WITH CLEAR COAT PROTECTION



ALL NEW



Check out our new and unique clearcoat finish. Fingerprints, dirt and rust don't stand a chance!

ED'S PICK

Stainless Steel Ball-Bearing GRIPLATCH®

Ball-bearing GRIPLATCH® storage offers the durability professionals prefer.

- Ball-bearing GRIPLATCH® drawer slides latch drawers closed
- Exclusive I-Frame® construction
- 5 x 2 inch casters with a 1,200-lb. load rating
- Gas struts in chest covers
- Large chest and roll-away handles for maneuverability



available in classic and diamond finish

BALL-BEARING STORAGE

CRAFTSMAN BALL-BEARING GRIPLATCH®

CRAFTSMAN®

BALL BEARING GRIPLATCH™



A & B. NEW-SAVE \$300 52-inch Combo. Separate prices total \$1,999.98-\$2,199.98. Wt. 535 lbs.

009-93232N♦ Black
 009-93233N♦ Red/Black
 009-93235N♦ Platinum/Black
 009-93234N♦ Midnight Blue
 009-93236N♦ Forest Green
1,699.98
 009-93237N♦ Yellow1,899.98

C & D. NEW-SAVE \$200 40-inch Combo. Separate prices total \$1,599.98-\$1,799.98. Wt. 416 lbs.

009-93238N♦ Black
 009-93239N♦ Red/Black
 009-93241N♦ Platinum/Black
 009-93240N♦ Midnight Blue
 009-93242N♦ Forest Green
1,399.98
 009-93243N♦ Yellow1,599.98

**BUY ONLINE
 PICK-UP IN STORE!**
 on eligible items

Ball-Bearing GRIPLATCH® Storage

Ball-bearing GRIPLATCH® storage offers the durability professionals prefer. Loaded with features, including:

- Ball-bearing GRIPLATCH® drawer slides that keep drawers closed
- Exclusive I-Frame® construction for strength and durability
- Heavy-duty 5 x 2-inch casters with a 1,000 lb. rating
- Full-width cover stiffener adds strength and storage space



A. 52-inch Wide 9-Drawer Chest	B. 52-inch Wide 14-Drawer Mobile Tool Cart	C. 40-inch Wide 7-Drawer Chest	D. 40-inch Wide 13-Drawer Mobile Tool Cart	E. 4 1/2-foot High 4-Drawer Side Locker
52W x 16D x 19 3/4H in.	52W x 18D x 41 1/2H in.	40 1/2W x 16D x 20 3/4H in.	40 3/4W x 18D x 41 1/2H in.	16W x 18D x 54 3/4H in.
12,218 cu. in. of storage	20,952 cu. in. of storage	9,597 cu. in. of storage	15,902 cu. in. of storage	10,872 cu. in. of storage
9 DRAWERS	14 DRAWERS	7 DRAWERS	13 DRAWERS	4 DRAWERS
FEATURES:				
Drawer depth 14 5/8 in. Two cover stays	Drawer depth 16 1/2 in. Medium-density fiberboard worksurface	Drawer depth 14 5/8 in. Full-width bottom drawer Two cover stays Security drawer locks independently	Drawer depth 16 1/2 in. Full-width top drawer Medium-density fiberboard worksurface	Drawer depth 16 1/2 in. Interchangeable drawers Mounts to either side of chest and tool cart combination
009-59629N♦ - Black 009-59729N♦ - Red/Black 009-82495N♦ NEW Platinum/Black 009-59381N♦ - Midnight Blue 009-61966N♦ - Forest Green 009-82497N♦ NEW Yellow	009-59631N♦ - Black 009-59731N♦ - Red/Black 009-82496N♦ NEW Platinum/Black 009-59382N♦ - Midnight Blue 009-61967N♦ - Forest Green 009-82498N♦ NEW Yellow	009-59621N♦ - Black 009-59721N♦ - Red/Black 009-82499N♦ NEW Platinum/Black 009-59383N♦ - Midnight Blue 009-61968N♦ - Forest Green 009-82501N♦ NEW Yellow	009-59622N♦ - Black 009-59722N♦ - Red/Black 009-82500N♦ NEW Platinum/Black 009-59384N♦ - Midnight Blue 009-61969N♦ - Forest Green 009-82504N♦ NEW Yellow	009-59605N♦ - Black 009-59705N♦ - Red/Black 009-82503N♦ NEW Platinum/Black 009-59385N♦ - Midnight Blue 009-61975N♦ - Forest Green 009-82504N♦ NEW Yellow
Wt. 190 lbs.	Wt. 345 lbs.	Wt. 141 lbs.	Wt. 275 lbs.	Wt. 102 lbs.
\$799.99 First 5 colors \$899.99 Traffic Yellow	1,199.99 First 5 colors 1,299.99 Traffic Yellow	599.99 First 5 colors 699.99 Traffic Yellow	999.99 First 5 colors 1,099.99 Traffic Yellow	519.99 First 5 colors 619.99 Traffic Yellow

BALL-BEARING GRIPLATCH®

YOUR CHOICE
OF SIX COLORS!

BLACK
RED/BLACK
PLATINUM/BLACK
MIDNIGHT BLUE
FOREST GREEN
TRAFFIC YELLOW



F & G. NEW-SAVE \$250 40-inch Combo.

Separate prices total \$1,399.98-\$1,599.98.

Wt. 401 lbs.

- 009-93244N♦ Black
- 009-93245N♦ Red/Black
- 009-93247N♦ Platinum/Black
- 009-93246N♦ Midnight Blue
- 009-93248N♦ Forest Green1,149.98
- 009-93249N♦ Yellow1,349.98

H & K. NEW-SAVE \$170 40-inch Combo.

Separate prices total \$1,169.98-\$1,369.98.

Wt. 381 lbs.

- 009-93250N♦ Black
- 009-93251N♦ Red/Black
- 009-93253N♦ Platinum/Black
- 009-93252N♦ Midnight Blue
- 009-93254N♦ Forest Green.....999.98
- 009-93255N♦ Yellow1,199.98

F. 40-inch Wide 8-Drawer Chest	G. 40-inch Wide 14-Drawer Mobile Tool Cart	H. 40-inch Wide 4-Drawer Chest	J. 40-inch Wide 1-Drawer Intermediate Chest	K. 40-inch Wide 6-Drawer Mobile Tool Cart	L. 15-inch Wide 6-Drawer Side Cabinet
40 1/2W x 16D x 19 3/4H in.	40 3/4W x 18D x 41 1/2H in.	40 1/2W x 16D x 20H in.	40 1/2W x 18D x 7 1/2H in.	40 3/4W x 18D x 41 1/2H in.	15 3/4W x 18D x 35 1/4H in.
9,434 cu. in. of storage	16,362 cu. in. of storage	9,994 cu. in. of storage	2,510 cu. in. of storage	17,668 cu. in. of storage	5,649 cu. in. of storage
8 DRAWERS	14 DRAWERS	4 DRAWERS	1 DRAWER	6 DRAWERS	6 DRAWERS
FEATURES:					
Drawer depth 14 5/8 in. Two cover stays Security drawer locks independently	Drawer depth 16 1/2 in. Medium-density fiberboard worksurface	Drawer depth 14 5/8 in. Two cover stays	Drawer depth 16 1/2 in. Adds additional storage to any 40-inch tool cart	Drawer depth 16 1/2 in. Medium-density fiberboard worksurface	Drawer depth 16 1/2 in. Mounts with bracket (included) to either side of any Craftsman ball-bearing roll-away at least 40H in.
009-59623N♦ - Black 009-59723N♦ - Red/Black 009-82505N♦ NEW Platinum/Black 009-59168N♦ - Midnight Blue 009-61970N♦ - Forest Green 009-82507N♦ NEW Yellow	009-59624N♦ - Black 009-59724N♦ - Red/Black 009-82506N♦ NEW Platinum/Black 009-59169N♦ - Midnight Blue 009-61971N♦ - Forest Green 009-82508N♦ NEW Yellow	009-59625N♦ - Black 009-59725N♦ - Red/Black 009-82509N♦ NEW Platinum/Black 009-59386N♦ - Midnight Blue 009-61972N♦ - Forest Green 009-82512N♦ NEW Yellow	009-59604N♦ - Black 009-59704N♦ - Red/Black 009-82511N♦ NEW Platinum/Black 009-59388N♦ - Midnight Blue 009-61974N♦ - Forest Green 009-82514N♦ NEW Yellow	009-59626N♦ - Black 009-59726N♦ - Red/Black 009-82510N♦ NEW Platinum/Black 009-59387N♦ - Midnight Blue 009-61973N♦ - Forest Green 009-82513N♦ NEW Yellow	009-59602N♦ - Black 009-59702N♦ - Red/Black 009-82515N♦ NEW Platinum/Black 009-59393N♦ - Midnight Blue 009-61984N♦ - Forest Green 009-82516N♦ NEW Yellow
Wt. 141 lbs.	Wt. 260 lbs.	Wt. 141 lbs.	Wt. 52 lbs.	Wt. 240 lbs.	Wt. 96 lbs.
\$549.99 First 5 colors	849.99 First 5 colors	429.99 First 5 colors	239.99 First 5 colors	739.99 First 5 colors	359.99 First 5 colors
\$649.99 Traffic Yellow	949.99 Traffic Yellow	529.99 Traffic Yellow	289.99 Traffic Yellow	839.99 Traffic Yellow	409.99 Traffic Yellow

♦See "N" suffix note on page 94a.

**BALL BEARING
GRIPLATCH™**

SMOOTH GLIDE, LATCHED DRAWERS

YOUR CHOICE OF SIX COLORS!

BLACK, RED/BLACK, PLATINUM/BLACK,
MIDNIGHT BLUE, FOREST GREEN,
TRAFFIC YELLOW

**CUSTOMER
review**
“This box worked perfectly
for 26 years & sits in my
garage now.”
Frankoz
Seattle



CRAFTSMAN®

A. 6-Drawer 18-Deep Chest	B. 3-Drawer Intermediate Chest	C. 8-Drawer Roll-Away	D. 6-Drawer Chest	E. 4-Drawer Intermediate Chest	F. 5-Drawer Roll-Away	G. 5-Drawer Chest	H. 6-Drawer Roll-Away
26W x 18D x 19 3/4H in.	26W x 18D x 13 1/4H in.	26 1/2W x 18D x 41 1/2H in.	26W x 16D x 19 3/4H in.	26 1/2W x 16D x 13 1/4H in.	26 1/2W x 18D x 41 1/2H in.	26W x 16D x 19 3/4H in.	26 1/2W x 18D x 35H in.
6,826 cu. in. of storage	3,394 cu. in. of storage	10,663 cu. in. of storage	6,063 cu. in. of storage	2,755 cu. in. of storage	12,264 cu. in. of storage	6,116 cu. in. of storage	8,375 cu. in. of storage
6 DRAWERS	3 DRAWERS	8 DRAWERS	6 DRAWERS	4 DRAWERS	5 DRAWERS	5 DRAWERS	6 DRAWERS
FEATURES:							
Drawer depth 16 1/2 in. Cover stay	Drawer depth 16 1/2 in. Fits between all 26-inch wide Craftsman chests and roll-aways	Drawer depth 16 1/2 in. Tubular side handle	Drawer depth 14 5/8 in. Cover stay	Drawer depth 14 5/8 in. Bulk storage area and 16-inch deep Craftsman chests and roll-aways	Drawer depth 16 1/2 in. Bulk storage area Tubular side handle	Drawer depth 14 5/8 in. Cover stay	Drawer depth 16 1/2 in. Tubular side handle
009-59618◆ - Black 009-59718◆ - Red/Black 009-82531◆ NEW Plat./Blk 009-59389◆ - Midnight Blue 009-61980◆ - Forest Green 009-82536◆ NEW Yellow	009-59603 - Black 009-59703 - Red/Black 009-82533 NEW Plat./Blk 009-59392 - Midnight Blue 009-61982 - Forest Green 009-82538 NEW Yellow	009-59619◆ - Black 009-59719◆ - Red/Black 009-82532◆ NEW Plat./Blk 009-59894◆ - Midnight Blue 009-61981◆ - Forest Green 009-82537◆ NEW Yellow	009-59616◆ - Black 009-59716◆ - Red/Black 009-82517◆ NEW Plat./Blk 009-59896◆ - Midnight Blue 009-61976◆ - Forest Green 009-82520◆ NEW Yellow	009-59601 - Black 009-59701 - Red/Black 009-82519 NEW Plat./Blk 009-59895 - Midnight Blue 009-61983 - Forest Green 009-82522 NEW Yellow	009-59617◆ - Black 009-59717◆ - Red/Black 009-82518◆ NEW Plat./Blk 009-59390◆ - Midnight Blue 009-61977◆ - Forest Green 009-82521◆ NEW Yellow	009-59614◆ - Black 009-59714◆ - Red/Black 009-82525◆ NEW Plat./Blk 009-59891◆ - Midnight Blue 009-61978◆ - Forest Green 009-82527◆ NEW Yellow	009-59615◆ - Black 009-59715◆ - Red/Black 009-82526◆ NEW Plat./Blk 009-59892◆ - Midnight Blue 009-61979◆ - Forest Green 009-82528◆ NEW Yellow
Wt. 102 lbs.	Wt. 61 lbs.	Wt. 160 lbs.	Wt. 90 lbs.	Wt. 61 lbs.	Wt. 139 lbs.	Wt. 84 lbs.	Wt. 125 lbs.
\$419.99 First 5 colors	219.99 First 5 colors	599.99 First 5 colors	399.99 First 5 colors	199.99 First 5 colors	499.99 First 5 colors	359.99 First 5 colors	489.99 First 5 colors
\$469.99 Traffic Yellow	269.99 Traffic Yellow	649.99 Traffic Yellow	449.99 Traffic Yellow	249.99 Traffic Yellow	549.99 Traffic Yellow	409.99 Traffic Yellow	539.99 Traffic Yellow

COLORS THAT STAND OUT

Check out this stylish new storage featuring a contrast of white paint with black accents. With a multitude of usage options ... you can be as creative as your imagination will take you! The combo features full-extension, removable ball-bearing drawer slides that support up to 50 lbs. per drawer. White color acts as dry erase. Two casters swivel and feature a brake, two are fixed. Optional anti-static casters dissipate static electricity.

ALL NEW



design studio



medical office



kitchen



STORAGE IN LIVING COLOR

26-INCH



L

A & C. NEW-SAVE \$170 14-Drawer Combo.

- Separate prices total \$1,019.98-\$1,119.98. Wt. 262 lbs.
- 009-93265N ♦ Black 849.98
- 009-93266N ♦ Red/Black..... 849.98
- 009-93268N ♦ NEW Platinum/Black 849.98
- 009-93267N ♦ Midnight Blue 849.98
- 009-93269N ♦ Forest Green 849.98
- 009-93270N ♦ NEW Traffic Yellow..... 949.98

D & F. NEW-SAVE \$100 11-Drawer Combo.

- Separate prices total \$899.98-\$999.98. Wt. 229 lbs.
- 009-93256N ♦ Black 799.98
- 009-93270N ♦ Red/Black..... 799.98
- 009-93258N ♦ NEW Platinum/Black 799.98
- 009-93257N ♦ Midnight Blue 799.98
- 009-93259N ♦ Forest Green 799.98
- 009-93260N ♦ NEW Traffic Yellow..... 899.98

G & H. NEW-SAVE \$250 11-Drawer Combo.

- Separate prices total \$849.98-\$949.98. Wt. 209 lbs.
- 009-95368N ♦ Black 599.98
- 009-95758N ♦ Red/Black..... 599.98
- 009-93262N ♦ NEW Platinum/Black 599.98
- 009-93261N ♦ Midnight Blue 599.98
- 009-93263N ♦ Forest Green 599.98
- 009-93264N ♦ NEW Traffic Yellow..... 699.98

J & K. NEW-SAVE \$50 Craftsman 10-Drawer Ball-Bearing Combo.

Combo provides 14,549 cu. in. of storage. Separate prices total \$699.98. Wt. 197 lbs.

- 009-93271N ♦ 649.98

J. NEW Craftsman 5-Drawer Ball-Bearing Chest.

Provides 6,095 cu. in. of storage. Recessed handles and cover support. Measures 26 1/2W x 16D x 19 3/4H in. Wt. 79 lbs.

- 009-82539N ♦ 299.99

K. NEW Craftsman 5-Drawer Ball-Bearing Roll-Away.

Provides 8,454 cu. in. of storage, and tubular side handle. Measures 26 1/2W x 18D x 34 1/4H in. Wt. 118 lbs.

- 009-82540N ♦ 399.99

L. NEW Craftsman Anti-Static Casters. Institutional grade casters dissipate static electricity in order to protect electronic devices. Anti-microbial finish resists bacteria. Pre-drilled holes make them simple to install on any Craftsman roll-away. Set of four double ball-bearing casters. Two casters swivel and feature toe breaks; two are fixed. Casters measure 5 x 1 1/4 in. and provide a 1,400 lb. load rating. Wt. 9 lbs.

- 009-82541 99.99

M & N. NEW-SAVE \$70 Craftsman 10-Drawer Ball-Bearing Combo.

Sturdy design features I-Frame® construction, premium finish and 4 1/2 x 1 1/2-inch casters with a 600 lb. load rating. Full-extension ball-bearing slides hold up to 50 lbs. per drawer. Internal locking system with two overmolded keys. Full-width rounded chrome drawer trim. Provides 12,993 cu. in. of storage. Separate prices total \$569.98.

- 009-94693N ♦ Cool Blue
- 009-94696N ♦ Traffic Yellow
- 009-94692N ♦ Sunset Orange 499.98

M. NEW Craftsman 6-Drawer Ball-Bearing Chest.

Provides 4,480 cu. in. of storage. Measures 26W x 12D x 19 3/4H in. Wt. 69 lbs.

- 009-87754N ♦ Cool Blue
- 009-87748N ♦ Traffic Yellow
- 009-87756N ♦ Sunset Orange..... 239.99

N. NEW Craftsman 4-Drawer Ball-Bearing Roll-Away.

Provides 8,513 cu. in. of storage. Measures 26 1/2W x 18D x 34 1/4H in. Wt. 103 lbs.

- 009-87755N ♦ Cool Blue
- 009-87749N ♦ Traffic Yellow
- 009-87757N ♦ Sunset Orange..... 329.99



CRAFTSMAN BALL-BEARING STORAGE



CRAFTSMAN BALL-BEARING STORAGE OFFERS THESE GREAT FEATURES:

- Drawer slides glide smoothly, supporting loads of 50 lbs. per drawer
- Exclusive I-Frame® construction for strength and durability
- 4 1/2 x 1 1/2-inch casters support load ratings up to 800 lbs.
- Internal locking system for convenient security

A. 6-Drawer Chest	B. 3-Drawer Intermediate Chest	C. 4-Drawer Roll-Away	D. NEW 4-Drawer Side Cabinet	E. 5-Drawer Chest	F. 2-Drawer Intermediate Chest	G. 5-Drawer Roll-Away
26W x 12D x 15 3/8H in.	26 1/2W x 12D x 12 1/4H in.	26 1/2W x 18D x 34 1/4H in.	17 3/4W x 10 1/2D x 29 1/4H in.	26W x 16D x 19 3/4H in.	26 1/2W x 16D x 10 1/4H in.	26 1/2W x 18D x 34 1/4H in.
3,458 cu. in. of storage	1,968 cu. in. of storage	8,513 cu. in. of storage	4,070 cu. in. of storage	6,095 cu. in. of storage	2,023 cu. in. of storage	8,454 cu. in. of storage
6 DRAWERS	3 DRAWERS	4 DRAWERS	4 DRAWERS	5 DRAWERS	2 DRAWERS	5 DRAWERS
FEATURES:						
Drawer depth 10 3/4 inch Cover stay Top center locking security drawer	Drawer depth 10 3/4 inch Fits between Craftsman 12 inch deep chests and roll-aways	Drawer depth 16 1/2 inch Exclusive I-Frame® construction 600-lb. load rating	Drawer depth 9 1/2 inch	Drawer depth 14 5/8 inch Cover stay	Drawer depth 14 1/2 inch Fits between Craftsman 12 inch and 16 inch deep chests and all roll-aways	Drawer depth 16 1/2 inch Exclusive I-Frame® construction 600-lb. load rating
009-61805 - Black 009-87732 - Red 009-87735 NEW - Platinum/Black 009-61806 - Midnight Blue	009-61807 - Black 009-87733 - Red 009-87736 NEW - Platinum/Black 009-61808 - Midnight Blue	009-61809N♦ - Black 009-87734♦ - Red 009-87737N♦ NEW - Platinum/Black 009-61810♦ - Midnight Blue	009-82583 - Black 009-82585 - Red 009-82584 NEW - Platinum/Black 009-82588 - Midnight Blue	009-62026 - Black 009-87738 - Red 009-87741 NEW - Platinum/Black 009-61812 - Midnight Blue	009-62028 - Black 009-87739 - Red 009-87742 NEW - Platinum/Black 009-61814 - Midnight Blue	009-62027N♦ - Black 009-87740N♦ - Red 009-87743N♦ NEW - Platinum/Black 009-61816N♦ - Midnight Blue
Wt. 65 lbs.	Wt. 36 lbs.	Wt. 103 lbs.	Wt. 50 lbs.	Wt. 79 lbs.	Wt. 38 lbs.	Wt. 118 lbs.
\$169.99	149.99	279.99	219.99	249.99	149.99	349.99

THE LARGER THE LOAD...THE SMOOTHER THE GLIDE

BALL-BEARING STORAGE



899.98
K & L

999.98
M & N



SEARS.COM/SHOPTOOLS

Sign up to be notified when items go on sale.

A & C. SAVE *100 26-inch 10-Drawer Combo. Separate prices total \$449.98. Wt. 168 lbs.
 009-61797N ♦ Black
 009-94691N ♦ Red
 009-94689N ♦ NEW Platinum/Black
 009-61798N ♦ Midnight Blue
349.98

E & G. SAVE *150 26-inch 10-Drawer Combo. Separate prices total \$599.98. Wt. 197 lbs.
 009-61801N ♦ Black
 009-94687N ♦ Red
 009-94685N ♦ NEW Platinum/Black
 009-61802N ♦ Midnight Blue
449.98

H & J. SAVE *250 26-inch 12-Drawer Combo. Separate prices total \$799.98. Wt. 233 lbs.
 009-93316N ♦ NEW Black
 009-93315N ♦ NEW Red
 009-93317N ♦ NEW Platinum/Black
 009-93318N ♦ NEW Midnight Blue
549.98

K & L. SAVE *200 40-inch 19-Drawer Combo. Separate prices total \$1,099.98. Wt. 330 lbs.
 009-61958N ♦ Black
 009-94683N ♦ Red
 009-94682N ♦ Platinum/Black
 009-61959N ♦ Midnight Blue
899.98

M & N. SAVE *200 40-inch 22-Drawer Combo. Separate prices total \$1,199.98. Wt. 385 lbs.
 009-93286N ♦ NEW Black
 009-93287N ♦ NEW Red
 009-93288N ♦ NEW Platinum/Black
 009-93289N ♦ NEW Midnight Blue
999.98

H. NEW 6-Drawer Chest	J. NEW 6-Drawer Roll-Away	K. 7-Drawer Chest	L. 12-Drawer Mobile Tool Cart	M. NEW 8-Drawer Chest	N. NEW 14-Drawer Mobile Tool Cart	P. NEW 6-Drawer Side Cabinet
26W x 12D x 19 3/4H in.	26 1/2W x 18D x 41 1/4H in.	40 1/2W x 12D x 19 1/2H in.	40 3/4W x 18D x 40 3/4H in.	40 1/2W x 16D x 19 3/4H in.	40 3/4W x 18D x 40 3/4H in.	15 3/4W x 18D x 35 1/4H in.
6,116 cu. in. of storage	8,375 cu. in. of storage	6,975 cu. in. of storage	16,416 cu. in. of storage	9,434 cu. in. of storage	16,362 cu. in. of storage	5,649 cu. in. of storage
6 DRAWERS	6 DRAWERS	7 DRAWERS	12 DRAWERS	8 DRAWERS	14 DRAWERS	6 DRAWERS
FEATURES:						
Drawer depth 10 3/4 inch Cover stay	Drawer depth 16 1/2 inch Exclusive I-Frame® construction 600-lb. load rating	Drawer depth 10 3/4 inch Cover stay	Drawer depth 16 1/2 inch Exclusive I-Frame® construction 800-lb. load rating	Drawer depth 14 5/8 inch Cover stay	Drawer depth 16 1/2 inch Exclusive I-Frame® construction 800-lb. load rating	Drawer depth 16 1/2 inch Mounts to either side of a Craftsman roll-away or cart at least 40H in.
009-82576N ♦ - Black 009-82573N ♦ - Red 009-82578N ♦ NEW Plat./Black 009-82581N ♦ - Midnight Blue	009-82577N ♦ - Black 009-82574N ♦ - Red 009-82580N ♦ NEW Plat./Black 009-82582N ♦ - Midnight Blue	009-61962N ♦ - Black 009-87744N ♦ - Red 009-87746N ♦ NEW Plat./Black 009-61964N ♦ - Midnight Blue	009-61963N ♦ - Black 009-87745N ♦ - Red 009-87747N ♦ - NEW Plat./Black 009-61965N ♦ - Midnight Blue	009-82547N ♦ - Black 009-82550N ♦ - Red 009-82552N ♦ - NEW Plat./Black 009-82554N ♦ - Midnight Blue	009-82548 ♦ - Black 009-82551N ♦ - Red 009-82553N ♦ - NEW Plat./Black 009-82555 ♦ - Midnight Blue	009-82559N ♦ - Black 009-82560N ♦ - Red 009-82564N ♦ - NEW Plat./Black 009-82570N ♦ - Midnight Blue
Wt. 81 lbs.	Wt. 152 lbs.	Wt. 100 lbs.	Wt. 230 lbs.	Wt. 125 lbs.	Wt. 260 lbs.	Wt. 85 lbs.
\$329.99	469.99	399.99	699.99	449.99	.749.99	299.99

♦ See "N" suffix note on page 94a.

QUIET GLIDE



drop front lid



40-INCH

899.98
A & B

26-INCH

649.98
C & E

CRAFTSMAN

A and B. SAVE \$140 Craftsman 40-inch 22-Drawer Combo.

Separate prices total \$1,039.98.

Wt. 358 lbs.

009-95756N ♦ - Red

009-95755N ♦ - Black

009-95754N ♦ - Blue899.98

C and E. SAVE \$90 Craftsman 26-inch 23-Drawer Combo.

Separate prices total \$739.98.

Wt. 248 lbs.

009-59343N ♦ - Red

009-59341N ♦ - Black

009-59342N ♦ - Blue649.98

G and H. SAVE \$90 Craftsman 26-inch 16-Drawer Combo.

Separate prices total \$689.98.

Wt. 243 lbs.

009-95769N ♦ - Red

009-95766N ♦ - Black

009-95763N ♦ - Blue599.98

K and L. SAVE \$80 Craftsman 26-inch 18-Drawer Combo.

Separate prices total \$629.98.

Wt. 230 lbs.

009-95773N ♦ - Red

009-95772N ♦ - Black

009-95790N ♦ - Blue549.98

N and Q. SAVE \$110 Craftsman 26-inch 13-Drawer Combo.

Separate prices total \$459.98.

Wt. 170 lbs.

009-95665N ♦ - Red

009-95663N ♦ - Black

009-95662N ♦ - Blue349.98

A. 40-inch Wide 8-Drawer Chest	B. 40-inch Wide 14-Drawer Mobile Tool Cart	C. 12-Drawer Drop-front Chest	D. 18-inch Deep Intermediate Chest	E. 11-Drawer Roll-Away	F. 6-Drawer Side Cabinet	G. 7-Drawer 18-inch Deep Chest	H. 9-Drawer Roll-Away
40 1/2W x 16D x 19 3/4H in.	40 3/4W x 18D x 40 3/4H in.	26W x 16D x 19 3/4H in.	26 1/2W x 18D x 13 1/4H in.	26 1/2W x 18D x 40 3/4H in.	15 3/4W x 18D x 35 1/4H in.	26W x 18D x 19 3/4H in.	26 1/2W x 18D x 40 3/4H in.
9,434 cu. in. of storage	16,362 cu. in. of storage	5,866 cu. in. of storage	3,394 cu. in. of storage	10,530 cu. in. of storage	5,649 cu. in. of storage	6,808 cu. in. of storage	10,618 cu. in. of storage
8 DRAWERS	14 DRAWERS	12 DRAWERS	3 DRAWERS	11 DRAWERS	6 DRAWERS	7 DRAWERS	9 DRAWERS
FEATURES:							
Drawer depth 14 5/8 in. Security drawer 2 Cover stays	Drawer depth 16 1/2 in. Spacious 40W x 18D x 1/2H in. thick worksurface 4 1/2 x 1 1/2-in. casters I-Frame® construction	Drawer depth 14 5/8 in. Cover stay Locking drop-front panel	Drawer depth 16 1/2 in. Fits between all 26W in. chests and roll-aways	Drawer depth 16 1/2 in. 4 1/2 x 1 1/2-in. casters I-Frame® construction	Drawer depth 16 1/2 in. Mounts to either side of a Craftsman roll-away or mobile tool cart at least 40H in.	Drawer depth 16 1/2 in. Cover stay	Drawer depth 16 1/2 in. Individually locking security drawer I-Frame® construction 4 1/2 x 1 1/2-in. casters
009-61928N ♦ - Red 009-61930N ♦ - Black 009-61932N ♦ - Blue	009-61929N ♦ - Red 009-61931N ♦ - Black 009-61933N ♦ - Blue	009-61940N ♦ - Red 009-65766N ♦ - Black 009-61944N ♦ - Blue	009-61923 - Red 009-61924 - Black 009-61925 - Blue	009-61941N ♦ - Red 009-61943N ♦ - Black 009-61945N ♦ - Blue	009-61956 - Red 009-59931 - Black 009-59929 - Blue	009-61934N ♦ - Red 009-61936N ♦ - Black 009-61938N ♦ - Blue	009-61935N ♦ - Red 009-61937N ♦ - Black 009-61939N ♦ - Blue
Wt. 115 lbs.	Wt. 243 lbs.	Wt. 99 lbs.	Wt. 54 lbs.	Wt. 149 lbs.	Wt. 77 lbs.	Wt. 101 lbs.	Wt. 142 lbs.
\$399.99	639.99	339.99	159.99	399.99	259.99	299.99	389.99

INNOVATIVE STORAGE...QUALITY ENSURED!

- EXCLUSIVE I-FRAME® FOR STRENGTH AND DURABILITY
- LOAD UP TO 50 LBS. PER DRAWER
- HEAVY-DUTY CASTERS HOLD UP TO 500 LBS.

40% QUIETER
30% SMOOTHER
THAN STANDARD SLIDES

QUIET GLIDE STORAGE



SHOP ON THE GO!
Visit sears2go.com on your mobile device

J. 2-Shelf Side Cabinet	K. 10-Drawer 16-inch Deep Chest	L. 8-Drawer Roll-Away	M. 4-Drawer Side Cabinet	N. 12-inch Deep Chest	P. 4-Drawer 12-inch Deep Deep Intermediate Chest	Q. 5-Drawer Roll-Away	R. 6-Drawer Tool Caddy
17 3/4W x 10 1/2D x 29 1/4H in. 4,956 cu. in. of storage 2 SHELVES	26W x 16D x 19 3/4H in. 5,932 cu. in. of storage 10 DRAWERS	26 1/2W x 18D x 40 3/4H in. 10,663 cu. in. of storage 8 DRAWERS	17 3/4W x 10 1/2D x 29 1/4H in. 4,070 cu. in. of storage 4 DRAWERS	26W x 12D x 19 3/4H in. 4,432 cu. in. of storage 8 DRAWERS	26 1/2W x 12D x 12 1/4H in. 1,926 cu. in. of storage 4 DRAWERS	26 1/2W x 18D x 33 3/4H in. 8,434 cu. in. of storage 5 DRAWERS	7 7/8W x 12D x 15 1/8H in. 868 cu. in. of storage 6 DRAWERS
FEATURES:							
Mounts to either side of any Craftsman roll-away or hangs on a flat surface. Shelves adjust at 3-in. intervals	Drawer depth 14 5/8 in. Cover stay Security drawer	Drawer depth 16 1/2 in. 4 1/2 x 1 1/2-in. casters I-Frame® construction	Drawer depth 9 1/2 in. Mounts to either side of any Craftsman roll-away. Also includes two adjustable shelves.	Drawer depth 10 3/4 in. Cover stay Security drawer	Drawer depth 10 3/4 in. Fits under all 12D in. chests and on all 26W in. roll-aways	Drawer depth 16 1/2 in. Two deep drawers 4 1/2 x 1 1/2-in. casters I-Frame® construction	Drawer depth 10 3/4 in. Mounts to either side of any Craftsman roll-away
009-65763 - Red 009-61918 - Black 009-61919 - Blue	009-61946N - Red 009-65328N - Black 009-61948N - Blue	009-61947N - Red 009-65330N - Black 009-61949N - Blue	009-61920 - Red 009-61921 - Black 009-61922 - Blue	009-62388 - Red 009-62384 - Black 009-62396 - Blue	009-61942 - Red 009-65950 - Black 009-59925 - Blue	009-62389N - Red 009-62385N - Black 009-62397N - Blue	009-61913 - Red 009-61916 - Black 009-61917 - Blue
Wt. 38 lbs. \$99.99	Wt. 93 lbs. 279.99	Wt. 137 lbs. 349.99	Wt. 47 lbs. 199.99	Wt. 67.3 lbs. 199.99	Wt. 39 lbs. 139.99	Wt. 103 lbs. 259.99	Wt. 24 lbs. 99.99

◆ See "N" suffix note on page 94a.

CRAFTSMAN®

Craftsman Homeowner Storage Solutions

Quality tool storage for the do-it-yourselfer, each unit offers these features:

- All-steel construction
- Smooth-opening steel drawer slides support up to 25 lbs. each
- 4 x 2-inch casters with a 500 lb. load rating
- External lock bar and two over-molded keys



A & C. NEW-SAVE \$100 10-Drawer Combo. 9,554 cu. in. of storage. Separate prices total \$299.98. Wt. 92 lbs.
009-93292N ♦ Red **199.98**
009-93273N ♦ Black **199.98**

D & E. NEW-SAVE \$20 9-Drawer Combo. 9,475 cu. in. of storage. Separate prices total \$199.98. Wt. 88 lbs.
009-93291N ♦ Black **179.98**
009-93272N ♦ Red **179.98**

F & G. SAVE \$100 12-Drawer Combo. 12,110 cu. in. of storage. Separate prices total \$319.98. Wt. 107 lbs.
009-59764N ♦ Black **219.98**
009-59773N ♦ **NEW** Red **219.98**

A. NEW 5-Drawer Chest	B. 2-Drawer Intermediate Chest	C. NEW 5-Drawer Roll-Away	D. NEW 5-Drawer Chest	E. NEW 4-Drawer Roll-Away	F. 7-Drawer Chest	G. 5-Drawer Roll-Away
26W x 12D x 17 1/4H in.	26W x 12D x 11 1/2H in.	26W x 14D x 32 1/2H in.	22W x 12D x 15 1/4H in.	26 1/2W x 14D x 31 3/4H in.	26 W x 12D x 17 1/4H in.	26 1/2W x 18D x 32 1/2H in.
3,275 cu. in. of storage	1,918 cu. in. of storage	6,279 cu. in. of storage	3,151 cu. in. of storage	6,324 cu. in. of storage	3,767 cu. in. of storage	8,343 cu. in. of storage
5 DRAWERS	2 DRAWERS	5 DRAWERS	5 DRAWERS	4 DRAWERS	7 DRAWERS	5 DRAWERS
FEATURES:						
10 3/4-inch Drawer Depth	10 3/4-inch Drawer Depth Fits between homeowner chests and roll-aways	12 3/4-inch Drawer Depth	10 3/4-inch Drawer Depth	12 3/4-inch Drawer Depth	10 3/4-inch Drawer Depth	16 1/2-inch Drawer Depth
009-62214 - NEW Red 009-62591 - Black	009-62230 - NEW Red 009-59889 - Black	009-62215N ♦ - NEW Red 009-62597N ♦ - Black	009-59556 - NEW Red 009-62589 - Black	009-59557N ♦ - NEW Red 009-62590N ♦ - Black	009-59768 - Red 009-59778 - Black	009-59769N ♦ - Red 009-59779N ♦ - Black
Wt. 37 lbs.	Wt. 21 lbs.	Wt. 55 lbs.	Wt. 33 lbs.	Wt. 55 lbs.	Wt. 40 lbs.	Wt. 67 lbs.
\$119.99	89.99	179.99	89.99	109.99	119.99	199.99

easy access to all your most-often-used tools

**BLACK,
RED &
BLUE**

AVAILABLE IN
DIAMOND ALUMINUM
& POWDERCOATED
STEEL



Catalog/Online EXCLUSIVE

H.-P. NEW Craftsman 26-inch Portable Tool Boxes in Diamond Aluminum and Powdercoated Steel. A great addition to the Craftsman storage family, this innovative portable storage solution displays all your tools at a glance. Crafted in rugged 0.08-inch diamond-pattern aluminum or 16-gauge steel, with all-welded seams, durable powdercoat finish and weather stripping to keep tools dry. Perfect for the top of any Craftsman 26-inch rolling storage cabinet, workbench, race trailer, truck or jobsite. Measures 26W x 17 3/8D x 18 1/2H in. Provides 5,667 cu. in. of storage. Made in USA. Warranted*.

- H. Brite Diamond Aluminum.** Wt. 47 lbs.
009-87706 Tools not included.....**579.99**
- J. Black Diamond Aluminum.** Wt. 47 lbs.
009-87707.....**579.99**
- K. Red Diamond Aluminum.** Wt. 47 lbs.
009-87708.....**579.99**
- L. Blue Diamond Aluminum.** Wt. 47 lbs.
009-87709.....**579.99**
- M. Black Steel.** Wt. 70 lbs.
009-87703.....**499.99**
- N. Red Steel.** Wt. 70 lbs.
009-87704.....**499.99**
- P. Blue Steel.** Wt. 70 lbs.
009-87705.....**499.99**

UNIQUE STORAGE

shown on a 26" roll-away cart – tools sold separately

>> Check online for SALE PRICING!

VIPER SS

Catalog/Online EXCLUSIVE Q and R. NEW-SAVE \$100 Viper Classic Special Edition 304 Stainless Steel 17-Drawer Combo. These 33-inch wide, 18 ga., 304 stainless steel units feature sturdy one-piece construction, extruded aluminum drawer pulls and 150 lb. ball-bearing slides. Offers 22,754 cu. in. of storage. Separate prices total \$1,399. Wt. 340 lbs.
009-94668N◆**1,299.99**

Catalog/Online EXCLUSIVE Q. NEW Viper Classic 10-Drawer 304 Stainless Steel Chest. The separate locking "whiskey drawer" keeps valuables locked while providing access to tools. Chest features dual gas struts and lid stiffener and has 7,838 cu. in. of storage. Measures 33W x 17 3/4D x 19 1/4H in. Wt. 155 lbs.
009-87890N◆**619.99**

Catalog/Online EXCLUSIVE R. NEW Viper Classic 7-Drawer 304 Stainless Steel Roll-Away. Featuring heavy-duty 5 x 2-inch casters. 14,916 cu. in. of storage. Measures 33 5/8W x 18 1/8D x 41H in. Wt. 185 lbs.
009-87891N◆**779.99**



features center lock box to hold valuables

Q NEW

R NEW

1,299.99



S NEW

379.99

Catalog/Online EXCLUSIVE S. NEW Viper Economy 430 Stainless Steel Chest/Roll-Away Combo. Both the 6-drawer chest and 2-drawer roll-away feature solid one-piece construction for added strength and full extension ball-bearing slides. Rollaway has 4 x 2 heavy-duty casters, 2 drawers and built-in storage bin. Both chest and rollaway have a secure locking system for your valuables. Offers 12,990 cu. in. of storage. Wt. 86 lbs.
009-83260**379.99**

*Warranted, see page 94a.
◆ See "N" suffix note on page 94a.



Craftsman Ball-Bearing GRIPLATCH® Utility Carts

- GRIPLATCH® drawer retention system
- Ball-bearing drawer slides
- Cover stiffener with Craftsman emboss
- Rubber bumpers (except D)
- Internal locking system
- Gas struts support cover
- Steel side handles provide easy handling
- Drawer liners and tool slots for easy organization



MORE TO EXPLORE
at sears.com!

Catalog/Online EXCLUSIVE

A. Craftsman 4-Drawer Black Ball-Bearing GRIPLATCH® Utility Cart. Provides 18,820 cu. in. of storage. 3-inch deep bottom shelf and four drawers (two full-width and two split). Reinforced caster channels and 5 x 2 in. casters (two fixed, two swivel) provide a 1,000 lb. load rating. Measures 38W x 21 1/4D x 41H in. (with side handle). Wt. 173 lbs.
009-59756N **499.99**

Catalog/Online EXCLUSIVE

B. Craftsman Stainless Steel 3-Drawer Ball-Bearing GRIPLATCH® Utility Cart. Provides 15,392 cu. in. of storage. 3 in. deep bottom shelf and three drawers (one full-width, two split). 5 x 2 in. casters (two fixed, two swivel) provide a 750 lb. load rating. Measures 34W x 20 1/2D x 37 1/4H in. (with side handle). Wt. 109 lbs.
009-59758 **449.99**

C. Craftsman 3-Drawer Black Ball-Bearing GRIPLATCH® Utility Cart. Provides 15,392 cu. in. of storage. 3-inch deep bottom shelf and three drawers (one full width, two split). 5 x 2-inch casters (two fixed, two swivel) provide a 750 lb. load rating. Measures 34W x 20 1/2D x 37 1/4H in. (with side handle). Wt. 109 lbs.
009-59740 **349.99**

Catalog/Online EXCLUSIVE

D. Craftsman 1-Drawer Black Ball-Bearing GRIPLATCH® Utility Cart. Provides 11,115 cu. in. of storage. 3-inch deep bottom shelf and one full-width drawer. Removable side shelf and screwdriver organizer included. Lid and drawer lock separately. 4 x 1-inch swivel casters provide a 400 lb. load rating. Measures 35 7/8W x 16 3/4D x 32 1/2H in. with screwdriver organizer. Wt. 80 lbs.
009-59736 **219.99**

Catalog/Online EXCLUSIVE

E. Craftsman Red Deluxe Service Cart. Crafted in heavy-duty 18-gauge steel, unit features two 4-inch drawers with ball-bearing slides, internal locking system, locking pry bar/ screwdriver compartment, folding side shelf, flip-up top compartment with two gas pistons and locking lid, a padded work surface and four 4-inch casters (two locking). Wt. 128 lbs.
009-59691 **279.99**



Also Available
Craftsman Deluxe Black Service Cart.
Wt. 128 lbs.
009-59750 **279.99**

Heavy-Duty Plastic Utility Carts

- Rugged plastic
- Molded-in side handle
- 5 x 1 inch casters (two fixed, two swivel) support up to 400 lbs.
- Lightweight for maneuverability

Catalog/Online EXCLUSIVE

F. Craftsman Large 2-Shelf Heavy-Duty Plastic Utility Cart. 5 x 1-inch casters with a 400 lb. load rating. Measures 40 1/2W x 25 3/4D x 32 1/2H in. Wt. 48 lbs.
009-59733 **169.99**

G. Craftsman Small 2-Shelf Heavy-Duty Plastic Utility Cart. 5 x 1-inch casters with a 300 lb. load rating. 34 1/2W x 17 1/2D x 32 1/2H in. Wt. 38 lbs.
009-59732 **99.99**



FREE WORK STOOL WITH THESE 4 WORKBENCHES

H. Craftsman 7-Foot, 7-Drawer Ball-Bearing Workbench. Provides 11,802 cu. in. of storage. Features extra large 84W x 30D x 1 1/2H in. treated fiberboard worksurface with black banded edges. Full-panel, pegboard-pierced sides, two deep drawers for larger tools and open center for additional storage. 84W x 30D x 37H in. Wt. 225 lbs.
009-93293N◆ 429.99

J. Craftsman 5-Foot, 7-Drawer Ball-Bearing Workbench. Provides 11,802 cu. in. of storage. Features large 60W x 24D x 1 1/2H in. treated fiberboard worksurface with banded edges. Full-panel, pegboard-pierced sides and one deep drawer. Measures 60W x 24D x 37H in. Wt. 160 lbs.
009-93295N◆ 379.99

K. Craftsman 5-Foot, 4-Drawer Ball-Bearing Workbench. Provides 16,555 cu. in. of storage. Features large 60W x 24D x 1 1/4H in. fiberboard worksurface and removable galvanized shell. Full-panel, pegboard-pierced sides and bulk storage area with two shelves. Measures 60W x 24D x 37H in. Wt. 138 lbs.
009-93294N◆ 309.99

Also Available
Craftsman 5-Foot, 4-Drawer Ball-Bearing Workbench. Same as "K" but with 1 1/2H in. treated fiberboard worksurface with banded edges. Wt. 138 lbs.
009-93296N◆ 299.99



FREE!
CRAFTSMAN WORK STOOL

Get a FREE Craftsman work stool with purchase of H, J, K or 009-93296 workbenches. A \$79.99 value.



429.99



379.99



309.99



BAMBOO SURFACE



DURABLE CHEMICAL-RESISTANT WORKSURFACE



8-FOOT WIDE

8 BALL-BEARING DRAWERS
649.99

M & N. SAVE \$40 Craftsman 4 1/2-Foot Ball-Bearing Workbench and Powered Backwall Combo. Separate prices total \$299.98. Wt. 137 lbs.
009-61825N◆ 259.99

M. Craftsman 4 1/2-Foot Powered Workbench Backwall. Steel pegboard and full-width steel shelf. Also includes light fixture and 3-outlet powerstrip. Mounts to "N" 009-59746. Measures 54W x 6D x 28H in. Wt. 31 lbs.
009-59747 99.99

N. Craftsman 4 1/2-Foot, 3-Drawer Ball-Bearing Workbench. Provides 17,941 cu. in. of storage. Features 54W x 23D x 1 1/4H in. fiberboard worksurface. Full-panel, pegboard-pierced sides and bulk storage area. Measures 54W x 23D x 37 3/4H in. Wt. 106 lbs.
009-59746N◆ 199.99



4 1/2-FOOT WIDE

259.99

Ball-bearing Workbenches

Heavy-duty, large capacity workbenches feature full-extension drawers with ball-bearing drawer slides for quick and easy access to all tools. Workbenches feature extra large worksurfaces, up to 8 ft. wide. Full panel sides with pegboard piercings support loads of 2,000 lbs. Bulk storage areas and shelves provide room to store larger items and supplies.

WORKBENCHES / CARTS

◆ See "N" suffix note on page 94a.

MILITARY-READY CARTS & CASES



Craftsman Indestructo®

The ultimate in protection and portability for your valuable tools. All these rugged cases feature powdercoated 3/4-in. tongue and groove aluminum frames with moisture and dirt inhibiting gaskets, recessed 3-in. corner in-line ball bearing wheels, butterfly twist latches, and telescoping handles. All accept TSA authorized combination locks. High-density polyethylene cases can withstand -40°F to +185°F temperature extremes. Foam-padded section and eight wraparound bumpers protect delicate tools. Tools not included. Warranted*.

- A. Craftsman Military-Ready 18W x 15D x 12H-inch Cart.** Hinged pallet set that holds up to 51 mechanical tools. Comes with TSA-compliant lock. Wt. 19.2 lbs.
009-59759 Black/Red.....**299.99**
- B. Craftsman Military-Ready 21 1/4W x 12 1/4D x 11H-inch Slim Cart.** Hinge pallet set holds 48 mechanical tools. With TSA-compliant lock. Wt. 18.75 lbs.
009-59829 Black/Red.....**269.99**
- C. Craftsman Military-Ready 28W x 22D x 12H-inch Cart.** Hinge pallet set has over 100 sewn pockets plus a complete pallet with sewn elastic that you can customize to fit your more unusual-shaped tools. With TSA-compliant lock. Wt. 36 lbs.
009-59920 Black/Red.....**399.99**
- D. Craftsman Military-Ready 19W x 19D x 11H-inch Square Cart.** Hinge pallet set holds 50 mechanical tools, plus there are elastic sewn straps to hold unusual shaped tools and 2 clear pockets for small parts. With TSA Compliant Lock. Wt. 21.6 lbs.
009-59805 Black/Red.....**319.99**
- E NEW Craftsman Military-Ready 21W x 16 1/2 D x 12H-inch Cart.** Hinged top pallet opens to a V-position holding 11 screw drivers and up to 5 needle-nose pliers. Also has pockets to hold a large 500 gram ball-pein hammer and 13" half round file. With TSA-compliant lock. Wt. 25 lbs.
009-82870 Black/Red.....**319.99**



Carts A thru E feature 3-inch in-line ball-bearing wheels, red frames and TSA-compliant locks.

- F-G.** Hand-carrying cases with the same rugged construction and features as A thru E.
- F. NEW Craftsman Military-Ready Electronic 18W x 15D x 10H-inch Tool Case.** Includes 2 removable sewn pallets that hold up to 50 electronic hand tools. Wt. 12 lbs.
009-82872 - Black/Black**179.99**
009-82871 - Yellow/Black.....**179.99**
- G. NEW Craftsman Slim Line Military-Ready Electronic 21 1/2W x 12 1/2D x 10H-inch Tool Case.** Includes 2 removable sewn pallets that hold up to 50 electronic hand tools. Wt. 13 lbs.
009-82874 - Black/Black**179.99**
009-82873 - Yellow/Black.....**179.99**
- H. Craftsman 18-inch Military-Ready Compact Cart.** Wing pallet set holds up to 70 electronic tools. Measures 18W x 15D x 12H in. Wt. 19.2 lbs.
009-59154 - Black**299.99**
009-59155 - Yellow**299.99**

- J. Craftsman 23-inch Super-Sized Contractor's Military-Ready Cart.** Hinged top pallet holds up to 48 tools, bottom holds 30 tools. Measures 23W x 18D x 13H in. Wt. 29.7 lbs.
009-95244 - Black.....**319.99**
009-95245 - Yellow**319.99**
- K. Craftsman 31-inch Military-Ready Cart.** Hinged pallet set holds up to 100 mechanic tools and features three clear storage pouches. Measures 31W x 15D x 13H in. Wt. 28.5 lbs.
009-95248 - Black.....**349.99**
009-95180 - Yellow**349.99**
- L. Craftsman 25-inch Military-Ready Master Mechanic Tool Cart.** Hinged top pallet holds 53 tools. Bottom removable pallet holds 21 tools and includes 3 clear pouches. Measures 25W x 15D x 12H in. Wt. 22 lbs.
009-95181 - Black**319.99**
009-95182 - Yellow**319.99**

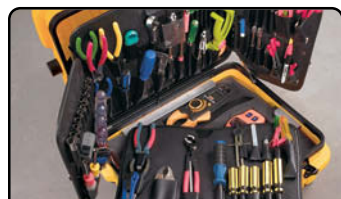

H. has removable wing pallet



K. features space for 100 mechanic's tools

CRAFTSMAN®

M and N. Craftsman Portable Tool Chests. Comfort-grip handle makes them easy to carry. Full-width staked piano hinge with watershed design resists springing. Includes full-extension compound-action drawer slides and two heavy-duty nickel-plated drawbolt latches (padlock not included). Drawers lock when lid is closed. All drawers measure 17 7/8W x 7 1/2D x 2 1/8H in. Chests measure 20 1/2W x 8 1/2D in.

M. 4-Drawer Chest. 1,840 cu. in. of storage. Measures 14 1/4 inches high. Wt. 26.25 lbs.
 009-82596 – Traffic Yellow 59.99
 009-61904 – Midnight Blue 59.99
 009-61905 – Black 59.99
 009-61906 – Red 59.99
 009-61903 – Forest Green 59.99
 009-82594 – Platinum/Black 59.99

N. 3-Drawer Chest. 1,588 cu. in. of storage. Measures 12 inches high. Wt. 19.4 lbs.
 009-82595 – Traffic Yellow 49.99
 009-65396 – Midnight Blue 49.99
 009-61901 – Black 49.99
 009-61902 – Red 49.99
 009-61900 – Forest Green 49.99
 009-82593 – Platinum/Black 49.99

BUY ONLINE
PICK-UP IN STORE!
 on eligible items



PORTABLE STORAGE

new colors—
 traffic yellow
 and platinum/black!

P. Craftsman Extra-Large Steel Flat-Top Tool Box. 2,169 cu. in. of storage. Tray: 23 7/16W x 8 13/16D x 3 5/8H in. Measures 24 1/4W x 9 1/2D x 9 1/2H in. Tools not included. Wt. 20 lbs.
 009-59241 69.99

Also Available
Craftsman Extra-Deep Steel Tool Box. Measures 20W x 8 1/2D x 9 1/2H in. Wt. 12.1 lbs.
 009-59212 39.99

Q. Craftsman 3-Drawer Portable Chest. 1,788 cu. in. of storage. Plastic shell guards against scratching. Three steel drawers with compound action drawer slides. Measures 23W x 10 1/2D x 13 1/2H in. Wt. 15.6 lbs.
 009-65628 49.99

R. Craftsman 4-Drawer Rally Box. Cantilever top tray for easy access. Drawers lock automatically when lid closes. Two drawbolt latches and tumbler lock with two reversible overmolded keys for added security. Full-width hinge with watershed design. Black wrinkle-finish shell, smooth-finish drawers. All drawers measure 17 7/8W x 7 1/2D x 2 1/8H in. Top tray measures 19 3/4W x 4 1/2D x 2H in. Measures 20 1/2W x 8 3/4D x 14 1/4H in. Wt. 26.8 lbs.
 009-65398 79.99

S. Craftsman 26-inch Hand Box. Provides 2,561 cu. in. of storage. Extra thick walls for lasting performance. Removable tote tray with level storage. Overmolded top handle and two side handles. Wt. 7.5 lbs.
 009-59326 29.99

T. Craftsman SST2 Sit/Stand/Tote. 5,081 cu. in. of storage. 5-inch wheels allow for easy transport of tools, sporting goods, and more over rough surfaces. High-impact polypropylene has a standing capacity of up to 250 lbs. Steel push-button, telescoping handle pulls out to a comfortable height of 36 inches. 10-inch bottom tub for bulk storage and a removable tote tray. Two side latches with padlock eye for security (padlock not included). Measures 25W x 17 1/2D x 18H in. Wt. 19 lbs.
 009-59627 59.99

built-in casters
 for easy transport



◆ See "N" suffix note on page 94a.

BENCH LAMPS IN BLUE, BLACK & RED



COOLER COLORS



NEON SIGN



yellow



neon orange



F



COOLER NEON STOOLS LAMP CLOCK



D

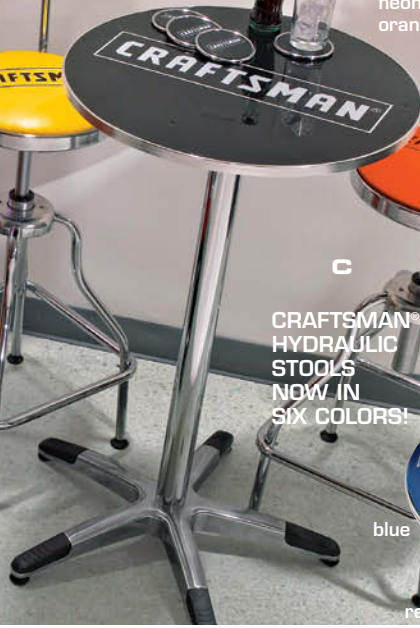

CRAFTSMAN HYDRAULIC STOOLS NOW IN SIX COLORS!

blue

red



G high back

COLORIZE YOUR WORKSPACE

Catalog/Online EXCLUSIVE

A. Craftsman Neon Sign. A fresh look at the classic 1927 Craftsman logo. This handmade neon sign features a diamond plate background enhanced with striking red and white neon. Hang on the wall or in a window. Measures 32W x 28H in. Wt. 9 lbs.
009-95705 199.99

B. Craftsman Retro Design Coolers. Rugged steel coolers feature a durable powdercoated finish and four easy-rolling caster wheels. Holds over 40 lbs. of ice and up to 24 cans or bottles of your favorite beverage. Includes built-in chrome opener and drain. Measures 34 x 30 x 19 1/2 in. Wt. 96 lbs.
009-62002 Silver 279.99
009-62000 Black 279.99
009-62001 Red 279.99

Catalog/Online EXCLUSIVE

C. Craftsman Hydraulic Stools. Work in comfort, Craftsman style. Durable padded adjustable backrest and seat offer comfort and support. Seat back is adjustable from 9.6 to 11.2 inches. The hydraulic cylinder adjusts seat height from 28 1/2 to 33 inches. Features non-slip adjustable feet for leveling and a durable high-polished chrome finish. Swivels 360 degrees. Neon orange, yellow, red, blue, black and green available online or in this catalog. Wt. 17.3 lbs.
NEW 009-82598 Neon Orange 79.99
NEW 009-52832 Yellow 79.99
NEW 009-82941 Red 79.99
009-52828 Blue 79.99
009-61828 Black 79.99
009-52830 Green 79.99

D. Craftsman Rolling Mechanic's Seat with Onboard Tool Tray. Designed for comfort and convenience, this 14-inch padded seat features a rotating vinyl cushion, chrome accents and sturdy frame. Includes hydraulic seat adjustment (lift height of 16 inches to 21 inches), five 3-inch casters (two locking) and a 17-inch steel tool tray with five removable trays. Warranted*. Wt. 22.5 lbs.
009-51828 79.99

Catalog/Online EXCLUSIVE

E. Craftsman 4-foot Fluorescent Bench Lamp. Features durable extruded aluminum housing with chainless hanging for installation. Clear acrylic lens, pull chain and 8-foot grounded power cord. Cold-climate rapid start electronic ballast - ideal for home, garage or workshop. UL listed and ENERGY STAR compliant! - uses 1/3 less electricity. Two-year full warranty*. Measures 57W x 3 1/2D x 2 2/5H in. Wt. 9 lbs. *Requires two SPX30 bulbs, sold separately.
034-95324 Blue 79.99
034-95321 Black 79.99
034-83028 Red 79.99

Catalog/Online EXCLUSIVE

F. Craftsman 20" Neon Shop Clock with 5/32 Glass Crystal. White neon tube will last 100,000 hours and gives this Art Deco classic its unique style. Powdercoated aluminum bezel. Includes a stylish black face featuring the Craftsman logo. 110-volt electric. Wt. 15 lbs.
009-95364 199.99

G. Craftsman High Back Hydraulic Seat. Here's a comfortable classic for work or relaxing. With a padded 360° swivel seat and back rest in a unique wrench design, this stool features a high-polished chrome frame and footrest with heavy-duty hydraulic cylinder to adjust height from 28 1/2 to 33 in. With non-slip self-leveling feet. Wt. 21 lbs.
009-52833 99.99

H. and J. Craftsman Signature Stools. Show your Craftsman spirit with these sturdy, comfortable stools. All stools feature a 360-degree swivel seat with thick foam pad. Crafted in CNC billet aluminum, stools feature a unique leg design with footrest. Includes assembly instructions and Allen wrench.
H. Craftsman Wrench Back Stool. Wt. 24 lbs.
009-52835 99.99
J. Craftsman Flame Back Stool. Wt. 24 lbs.
009-52834 99.99

K. Craftsman High Top Table. The perfect setting to relax, this handsome black vinyl-coated table features the classic Craftsman logo. Features high-polished, chrome-finished center post, and five-star legs with non-slip feet. Includes 4-piece coaster set. Measures 24W x 24D x 40H in. Wt. 22 lbs.
009-52590 99.99

L. Craftsman Coasters Only.
009-52591 9.99



H wrench back



K



J flame back



M

all stools feature 360-degree swivel seat

Catalog/Online EXCLUSIVE
M. Craftsman iPod/MP3 Player Compatible Folding Chair. Crafted in fade- and water-resistant polyester with sturdy powdercoated aluminum legs. Folds easily for storage. Holds up to 225 lbs. Features nylon mesh cup holders and carrying bag. Wt. 6 lbs.
009-74958 Red 26.99
009-74959 Black 26.99



N

Catalog/Online EXCLUSIVES

N. NEW Coca-Cola® Neon Clock. Light up your work area with this diner-style Classic Coca-Cola neon clock. Features simulated-chrome frame and bright white neon ring inside rim. Uses 1 AA battery. Measures 14 3/4 in. dia. Warranted*.

009-87910 39.99

P. NEW Retro Coca-Cola Neon Signs.

Add some vibrant atmosphere to your shop or game room with these bright neon signs. Feature classic Coca-Cola styling in authentic glass. Wt. 19 lbs.

009-84100 Drink in Bottles 28W x 24H x 7D in. 299.99

009-84101 Bottle Cap 25W x 25H x 7D in. 279.99

009-84102 Drug Store 26W x 22H x 7D in. 349.99

009-84097 379.99

Q. NEW Coca-Cola Rolling Cooler. Vintage look and modern construction deliver refreshing results with this roomy cooler featuring sturdy metal design with dual opening, folding top doors and spacious lower storage. Easy-grip handles and wheels for transport. Measures 34W x 15D x 33H in. Wt. 60 lbs.

009-84097 379.99

R. NEW Coca-Cola Pub Table. The classic Enjoy Coca-Cola logo complements this sturdy laminate-coated 30-in. table top. With rugged high-polished chrome center post, five-star non-slip legs and foot ring. 42 in. high. Wt. 42 lbs.

009-84104 149.99

S. thru X. NEW Coca-Cola Vintage Logo Stool. Relax with a classic on these comfortable fountain-style stools featuring classic Coke designs from the past. All stools feature seamless, non-swivel 5-inch comfortable foam pads, single foot ring and non-skid footpads.

009-87789 79.99

009-52603 39.99

009-87787 39.99

009-84105 39.99

009-87788 39.99

009-87786 39.99

009-87786 39.99

009-87786 39.99

009-87786 39.99

009-87786 39.99

009-87786 39.99

009-87786 39.99

009-87786 39.99

009-87786 39.99

009-87786 39.99

009-87786 39.99

009-87786 39.99

009-87786 39.99

009-87786 39.99

009-87786 39.99

009-87786 39.99

009-87786 39.99

009-87786 39.99

009-87786 39.99

009-87786 39.99

009-87786 39.99

009-87786 39.99

009-87786 39.99

009-87786 39.99

009-87786 39.99

009-87786 39.99

009-87786 39.99

009-87786 39.99

009-87786 39.99

009-87786 39.99

009-87786 39.99

009-87786 39.99

009-87786 39.99

009-87786 39.99

009-87786 39.99

009-87786 39.99

009-87786 39.99

009-87786 39.99

009-87786 39.99

009-87786 39.99

009-87786 39.99



GARAGE LIVING



SEARS.COM/SHOPTOOLS
 Sign up to be notified when items go on sale.



*Warranted, see page 94a.



Craftsman Neon Shop Clock sold on page 26.



CUSTOMER review

“This is a very sturdy and reliable cabinet—don’t be fooled by the price.”
Reviewer Pennsylvania

CRAFTSMAN PROFESSIONAL GARAGE STORAGE



A and C. SAVE \$50 Craftsman Professional Wall and Floor Cabinet. See chart for details. Buy both and save. Separate prices total \$509.98. Wt. 260 lbs.
009-93274N ♦ **Combo 459.98**

D and E. SAVE \$50 Craftsman Professional Workbench and Backwall. See chart for details. Buy both and save. Separate prices total \$539.98-\$409.98.
009-93276N ♦ 8 Foot. Wt. 282 lbs. **489.98**
009-43275N ♦ 5 Foot. Wt. 200 lbs. **359.98**

Catalog/Online EXCLUSIVE G. SAVE \$100 Craftsman 10-Drawer Ball-Bearing Combo. Platinum and black finish complements Craftsman Professional Garage Storage. Provides 11,971 cu. in. of storage. See 009-87735 and 009-87737 on page 16 for details. Separate prices total \$449.98. Wt. 168 lbs.
009-94689N ♦ **Combo 349.98**

Catalog/Online EXCLUSIVE H. Craftsman Magnetic Fluorescent Project Light. Magnetic base adheres to most metal surfaces. Flexible gooseneck rotates 350 degrees. Two outlets. 12-foot, 6-gauge cord, 12-amp circuit breaker. Two PL13 fluorescent bulbs, included. Wt. 4.85 lbs.
034-73853 **39.99**

Catalog/Online EXCLUSIVE J. 40-piece Floor Tile Set. 12-inch square solvent-resistant tiles clean up with hose or powerwash. Slip-resistant tiles come in four colors. Warranted*.
Wt. 31 lbs.
009-61015 Black **119.99**
009-61016 Platinum **119.99**
009-61017 Ultra Red **119.99**
009-61018 Beige **119.99**

Black Corner Edging. Wt. 0.02 lb.
009-63022 **1.99**

Black Edging Set of 4. Wt. 2.2 lbs.
009-63020 **11.99**



*Warranted, see page 94.
♦ See “N” suffix note on page 94.

A. Craftsman Professional Floor Cabinet-Shelves	B. Craftsman Professional Floor Cabinet-Locker	C. Craftsman Professional Wall Cabinet	D. Craftsman Professional 8-Foot Backwall	E. Craftsman Professional 8-Foot Workbench	F. Craftsman Professional 5-Drawer Mobile Cabinet
36W x 21 1/2D x 67H in. 43,683 cu. in. of storage	36W x 21 1/2D x 67H in. 43,683 cu. in. of storage	28W x 12 1/2D x 31H in. 8,259 cu. in. of storage	5-ft. backwall also available	96W x 24D x 39 3/4H in.	28W x 21 1/2D x 36H in. 10,104 cu. in. of storage
Three full-width shelves (two are adjustable) Ten welded shelves Inside doors Four rubber leveling feet Internal locking system Fully assembled	Same as 009-59126 but with one full-width adjustable shelf Two adjustable half-shelves Locker-style storage on right side Fully assembled	Two full-width adjustable shelves Five welded door shelves Internal locking system Mounts directly to wall or Craftsman Pro backwall Fully assembled	Mounts to 8-foot workbench Includes pegboard storage Steel construction Holds Craftsman Professional wall cabinets	Steel legs with pegboard sides and built-in shelves Four adjustable leveling feet Steel support beam below top 1/2-inch thick treated fiberboard worksurface Backsplash with tool piercings	Ball-bearing drawer slides I-Frame™ construction Reversible 2-in-1 worksurface features fiberboard top and galvanized shell Four 4 x 2-inch casters Fully assembled
009-59126N ♦ Wt. 175 lbs.	009-59125N ♦ Wt. 171 lbs.	009-59175 Wt. 85 lbs.	8 Ft. 009-59187N ♦ Wt. 102 lbs.	8 Ft. 009-59186N ♦ Wt. 180 lbs.	009-59130N ♦ Wt. 148 lbs.
\$329.99	329.99	179.99	189.99	349.99	399.99

VIPER® STAINLESS STEEL STORAGE MODULAR COMPONENTS

STORAGE SOLUTIONS

worktop features laser-etched tape measurements

CREATE YOUR WORKSPACE WITH ENDLESS CONFIGURATIONS!

VIPER SS

41-inch ultimate tool box

K



Catalog/Online EXCLUSIVE
K. Viper SS 41-inch, 11-Drawer 304 Stainless Steel Ultimate Tool Box. Innovative design features two sliding vertical steel pegboard drawers for large hanging tools. Middle drawer doubles as a work surface and roomy lower cabinet stores larger items. Also features ball-bearing slides, stainless steel side handles, double-pin locking system, hydraulic lid struts and 5-inch heavy-duty casters. Lid stiffener adds strength. Offers 17,293 cu. in. of storage. 41W x 18D x 57 1/2H, nine drawers measure 23 1/2W x 16 1/2D, two 2H, three 3 1/8H, three 5 1/2 H, one 14 1/2H in. Imported. Wt. 308.7 lbs.

009-95225N ♦ **1,099.99**

Catalog/Online EXCLUSIVE
L. NEW Viper Pro 72-inch 13-Drawer 304 Stainless Steel Chest. With the same heavy-duty 304 stainless steel construction, ball-bearing slides with 250 lbs. load rating, extruded aluminum drawer pulls and coded cam lock, this chest provides an additional 50,200 cu. in. of storage. 71 1/2W x 29 1/2D x 23 1/8H. Wt. 609 lbs.

009-83261N ♦ **2,099.99**

Catalog/Online EXCLUSIVE
M. Viper Pro 72-inch 18-Drawer 304 Stainless Steel Rolling Cart. Massive 72-inch heavy-duty 304 stainless steel unit has 18 drawers, each with a 250 lb. capacity and full-length ball-bearing slides. With stainless steel side handles and 6 x 2-inch heavy-duty casters, this rolling cart provides 55,261 cu. in. of storage. 72W x 29.9D x 37H in. Wt. 983.4 lbs.

009-99923N ♦ **2,899.99**

Also Available
Viper Pro 60-inch 11-Drawer 304 Stainless Steel Rolling Cart. All the same features as the 72-inch unit above with 46,419 cu. in. of storage. 60W x 26D x 37.4H in. Wt. 727 lbs.

009-99922N ♦ **2,499.99**

L NEW



M massive 72-inch rolling cart with 18 drawers

Catalog/Online EXCLUSIVES

N. Stainless Steel Worktops. Protect or modernize your existing tool cart's surface. Designed to fit most rolling cabinets, these 304 stainless tops are incredibly durable, with laser-etched tape measure feature

26 1/8W x 17 1/2D x 1 1/2H in. Wt. 26 lbs.

009-62013 **139.99**

40 1/2W x 17 1/2D x 1 1/2H in. Wt. 41 lbs.

009-62014 **199.99**

N stainless steel worktop



P. Viper 304 Stainless Steel Cabinet	Q. Viper 304 Stainless Steel 4-Drawer Rolling Cabinet	R. Viper 304 Stainless Steel Drawer Unit	S. NEW Viper 304 Stainless Steel 72-inch Workbench	T. NEW Viper 430 Stainless Steel Peg Board
26 1/2W x 18 1/4D x 28 1/2H in. 13,783 cu. in. of storage	26 1/2W x 18 1/4D x 28 1/2H in. 9,500 cu. in. of storage	26 1/2W x 18 1/4D x 8 1/4H in. 2,375 cu. in. of storage	72W x 26D x 40H in. —	36W x 1D x 24H in. —
FEATURES				
Cabinet can be hung on a 300 lb. wall, bolted together and stacked and/or fitted with casters. Casters not included. Includes one adjustable shelf. Imported.	Features 100 lb. rated ball-bearing slides. Mounted on 4 x 2 in. swivel casters. Casters included. Imported.	Features 100 lb. load rated ball-bearing slides. Bolt to other Viper units to add extra storage. Imported.	This workbench is great looking and incredibly durable. Features laser-etched tape measurements for quick and easy measuring while working. Imported.	Hang tools in style. Stainless steel pegboard feature standard hole pattern. Great for offices also. Imported.
009-62003	009-62004N ♦	009-62005	009-62006N ♦	009-62007
Wt. 68 lbs.	Wt. 104 lbs.	Wt. 32 lbs.	Wt. 146 lbs.	Wt. 18 lbs.
\$399.99	479.99	179.99	499.99	129.99



shown: 12-foot storage system with one extra shelf

Gorilla® Garage Industrial Grade Storage – Open Stock.*

Item	Catalog No.	Description	Wt., lbs.	Price
A.	009-95625N◆	Complete Stand-Alone Shelf Unit 72H x 48W x 24D in., 3 Shelves	123	\$249.99
B.	009-95626N◆	Cabinet Kit, Locking Doors, 2 Sides and Back, 48W x 36H in.	65	199.99
C.	009-95627N◆	Workbench Unit, 72H x 48W x 24D in. (Shown with extra shelf.)	138	399.99
D.	009-95628N◆	Drawer Kit for Shelving Unit and Workbench, 48W x 8D in.	42	99.99
E.	009-95629N◆	Extra Shelf for Shelving Unit or Workbench, 48W x 24D in.	30	59.99

Gorilla® Garage

Introducing an industrial-grade modular storage system with unparalleled strength and flexibility.

- 5/8-in. shelves measure 24 x 48 in. with 1,200 lb. capacity.
- 16-gauge heavy-duty steel frame with rust/corrosion-resistant finish.
- Shelves and pegboard finished with "Polymer Finish Technology" for a long-lasting durable finish.
- Workbench features solid hardwood butcher block top, 8-in. deep drawers, and pegboard.
- Locking steel cabinet doors with pegboard sides and back.
- 8-inch deep drawers feature double-rivet assembly and ball-bearing glides.
- All components are compatible for optimum customization.

Catalog/Online EXCLUSIVE

A thru E. SAVE \$170 Gorilla 16-foot Storage System.

Includes 3-A, 2-B, 1-C, 4-D and 2-E sections. Made in USA. Warranted*. Separate prices total \$2,069.88. Wt. 865 lbs.

009-95666N◆1,899.88

Also Available

SAVE \$120 Gorilla 12-foot Storage System. Includes 2-A, 1-B, 1-C, 2-D and 2-E sections. Made in USA. Warranted*. Separate prices total \$1,419.92. Wt. 593 lbs.

009-95667N◆1,299.92

SAVE \$70 Gorilla 8-foot Storage System.

Includes 1-A, 1-B, 1-C, 0-D and 2-E sections. Made in USA. Warranted*. Separate prices total \$969.95. Wt. 386 lbs.

009-95668N◆899.95

HOLDS UP TO 1,000 LBS PER SHELF!

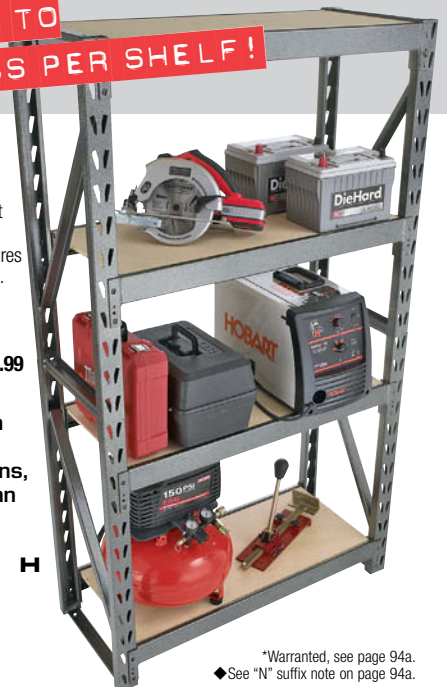

Catalog/Online EXCLUSIVE

H. NEW Gorilla Rack Flex-Rack™. A compact addition to the Gorilla shelving selection. Measures 41W x 17D x 72H inches. Each of the 4 adjustable shelves holds 1,000 lbs. Wt. 83 lbs. 009-10420149.99

a single rack can be set up in any of 3 configurations, multiple racks can be connected

Durham® Sturdy All-Steel Parts Bins

The time-proven system for the organization and storage of small parts. Sturdy all-steel, fully welded construction. Powdercoat finish resists corrosion and is four times thicker than paint.

- Open compartments for easy identification.
- 12-compartment bin offers larger openings for larger items.
- 11 7/8 in. deep compartments for extra capacity.
- Dividers are hemmed in teardrop design for added strength, ribbed to avoid sharp edges.
- 1 1/8 in. high bin fronts retain parts and can be used for labeling.



ALL NEW

Durham All Steel Parts Catalog/Online EXCLUSIVE

Item	Catalog Number	Number of Bins	Overall Dimensions, in.	Bin Dimensions, in.	Ship Weight	Price
F.	009-95366	12	33 3/4W x 12D x 23 7/8H	8W x 11 7/8D x 6 5/8H	36 lbs.	\$99.99
G.	009-95367	40	33 3/4W x 12D x 23 7/8H	4W x 11 7/8D x 4 1/2H	50 lbs.	129.99

*Warranted, see page 94a. ◆ See "N" suffix note on page 94a.



All Catalog/Online EXCLUSIVE

J & K. NEW SAVE \$30 Gerstner® International Red Oak Hobbyist Combo. Complementary chest and base provide moisture-free storage for your vital tools and materials. Separate prices total \$429.98. Imported. Warranted*. Wt. 42 lbs.

009-93320 399.98

J. Gerstner® International Red Oak Hobby Chest. Great for hobbies where space is a premium. Eight drawers with locking front lid to protect your materials. Measures 20W x 10D x 13 1/2H in. Imported. Warranted*. Wt. 23 lbs.

009-59658 229.99

K. NEW Gerstner® International Red Oak Hobby Base. Extended storage for hobbyists. Single key locks the front lid. Features two half-width drawers and two full-width drawers for ample yet portable storage. 21 1/2W x 9 1/2H x 11D in. Imported. Warranted*. Wt. 19 lbs.

009-83224 199.99

L. Gerstner® International Red Oak Utility Hand Box. The ideal project box for small home repairs and improvements. Details include polished chrome-plated hardware, felt lining and padded leather handle. Measures 16W x 8D x 9 3/4 H in. Imported. Warranted*. Wt. 11 lbs.

009-95101 129.99

M, N & P. SAVE \$100 Gerstner® International Red Oak Tool Chest, Base and Roll-Away System. The professional's choice for a full set-up. Set includes machinist's tool chest, base and rolling storage unit. Separate prices total \$1,079.97. Imported. Warranted*. Wt. 178 lbs.

009-95103 979.97

M and N. SAVE \$50 Gerstner® International Red Oak Machinist Storage Combo. Plenty of storage space and individual drawers for all your tools and collections. Separate pieces total \$509.98. Imported. Warranted*.

009-61869 459.98

M. Gerstner® International Machinists Tool Chest. Our most popular deluxe tool chest! 10 drawers offer compartmentalized storage. Measures 24W x 10D x 16 1/4H in. Imported. Warranted*. Wt. 33 lbs.

009-59657 279.99

N. Gerstner® International Red Oak Machinists Base. Add storage space to your top box. 4 drawers provide ample space for even more tools and equipment. Front locking lid. Measures 25 1/2W x 11 1/2D x 10H in. Imported. Warranted*. Wt. 22 lbs.

009-61868 229.99



K NEW

pop-out tray

These roomy units are ideal for moisture-free storage of precision tools, hobby materials and valuables. Crafted in American red oak with tongue-and-groove joinery, units feature a hand-rubbed stain with lacquer finish, felt lining and chrome-plated hardware.

P & Q. NEW SAVE \$70 Gerstner® International Red Oak Storage Master Combo. Exceptional craftsmanship defines these units, crafted from American red oak with tongue and groove joinery and hand-rubbed lacquer finish. Roomy and ideal for moisture-free storage of tool and hobby materials. Separate prices total \$969.98. Imported. Warranted*. Wt. 170 lbs.

009-94669 899.98

P. Gerstner® International Red Oak Rolling Storage Cabinet. Reversible top panel for felt or red oak work surface. Extra large wheels for smooth rolling. Six drawers include top shallow parts drawer that reverses to a work surface. Full extension ball bearing slides. Measures 31W x 20 1/2D x 34 1/2H in. Imported. Warranted*. Wt. 115 lbs.

009-95102 569.99

Q. NEW Gerstner® International Red Oak Storage Master. Our largest chest yet! Deeper drawers for ample storage of bulkier items. Two half drawers for smaller items. Five full-width drawers on full extension ball-bearing slides hold over 70 pounds each. Fits perfectly on our #95102 Rolling Storage Cabinet (listed above). Measures 25 1/2W x 16D x 18 1/2H in. Imported. Warranted*. Wt. 55 lbs.

009-87689 399.99



Q NEW

Here's versatile, durable hardwood storage with the look and feel of fine handmade furniture.

ED'S PICK



STORAGE SOLUTIONS

SHOP ON THE GO!
Visit sears2go.com on your mobile device



All Catalog/Online EXCLUSIVES

R. Akro-Mils® ProCart™ Double-Duty Utility Cart. High-density polyethylene structural foam construction. Flip hinged side gates down or flip side gates up and ProCart is a box-top cart. I-beam design makes loading and unloading oversized items on the lower shelf easy. 400-pound capacity. Tools not included. Wt. 62 lbs.

009-59096 184.99

S. Akro-Mils® ProCart™ Storage Bin System. Create a mobile work center to keep your small parts organized. 36 heavy-duty bins hang from optional nine-rail kit on ProCart. Tools not included. Wt. 30 lbs.

009-59097 124.99

Also Available Akro-Mils® Rail Kit for ProCart™ Utility Cart. Includes nine steel rails to hang bins on ProCart. Industrial grade, easy assembly. Wt. 24 lbs.

009-59099 50.99



T. Akro-Mils® 20-Drawer Industrial Grade Steel Parts Storage Cabinet. For organizing small parts, this sturdy unit features removable rust-, corrosion- and dent-proof drawers with rear stop tab to prevent spills. Design has no sharp edges that might damage parts. Measures 17W x 11D x 11H in. Wt. 20.5 lbs.

009-65622 62.99

U. Akro-Mils® Roto Shelf Mobile Storage Unit. Move your tools effortlessly to different work areas with this compact red and black storage unit. Features four shelves that rotate independently on center shaft. Each shelf is divided into six compartments and holds up to 75 pounds. Total unit capacity is 300 pounds. Tools not included. Warranted*. Wt. 38 lbs.

009-61888 134.99

SELECT THE PERFECT MODULE, CHOOSE ONE OF OUR COMBINATIONS, OR ASSEMBLE YOUR OWN TO FIT THE WAY YOU WORK!

CREATE THE ULTIMATE MECHANIC'S

1 300-piece starter set

- 168 SOCKETS
- 19 DRIVE TOOLS
- 53 WRENCHES
- 6 SCREWDRIVERS
- 54 SPECIALTY TOOLS

This set features an extensive range of sockets in all three drive sizes, inch and metric, regular and deep. A wide selection of drive tools, wrenches and specialty tools. See chart on pg. 35 for tools. Made in USA. Wt. 60.5 lbs.

Separate prices total \$1,502.28
009-33300Set 599.99

2 198-piece expansion set

- 84 SOCKETS
- 8 DRIVE TOOLS
- 60 WRENCHES
- 9 SCREWDRIVERS
- 37 SPECIALTY TOOLS

When you need speed, heavy-duty pawless ratcheting wrenches are the answer. This set features 5 types of wrenches to tackle a variety of applications. See chart on pg. 36 for tools. Made in USA. Wt. 50.9 lbs.

Separate prices total \$1,339.89
009-33198Set 699.99

3 189-piece specialized expansion set

- 102 SOCKETS
- 10 DRIVE TOOLS
- 39 WRENCHES
- 5 PLIERS
- 14 SCREWDRIVERS
- 19 SPECIALTY TOOLS

The right tool makes the difference. Extreme Grip wrenches, T-handle hex keys, extra long and Torx® screwdrivers, flex head ratchets and more. See chart on pg. 36 for tools. Made in USA. Wt. 70.8 lbs.

Separate prices total \$1,492.17
009-35189Set 799.99

4 204-piece access set

- 37 FLEX SOCKETS
- 8 DRIVE TOOLS
- 67 WRENCHES
- 10 SCREWDRIVERS
- 82 SPECIALTY TOOLS

These tools will get you into those tight spaces. Set features ball end T-handle hex keys, flex sockets, crowfoot and midjet wrenches and adjustable pliers. See chart on pg. 37 for tools. Wt. 32 lbs.

Separate prices total \$1,060.45
009-33204Set 799.99

5 106-piece advanced set

- 9 DRIVE TOOLS
- 56 WRENCHES (53 FULL POLISH)
- 22 PROFESSIONAL SCREWDRIVERS
- 19 SPECIALTY TOOLS

Packed with the tools that the professionals prefer, this set features Cross-Force™ full polish wrenches. See chart on pg. 38 for tools. Made in USA. Wt. 51 lbs.

Separate prices total \$1,340.20
009-35106Set 899.99

page 35

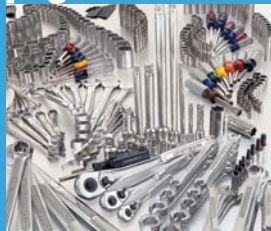

page 36



page 36



page 37



page 38



module 1

- 168 sockets
- 19 drive tools
- 53 wrenches
- 6 screwdrivers
- 54 specialty tools

Separate prices total \$1,502.28.
009-33300....Set 599.99

modules 1+2 combined

- 252 sockets
- 27 drive tools
- 113 wrenches
- 15 screwdrivers
- 91 specialty tools

Separate prices total \$2,842.17.
009-33498....Set 1,299.98

modules 1+2+3 combined

- 354 sockets
- 152 wrenches
- 29 screwdrivers
- 115 specialty tools
- 37 drive tools

Separate prices total \$4,334.34.
009-34678Set 2,099.97

modules 1+2+3+4 combined

- 391 sockets
- 45 drive tools
- 219 wrenches
- 39 screwdrivers
- 197 specialty tools

Separate prices total \$5,394.79.
009-33891Set 2,899.96

modules 1+2+3+4+5 combined

- 391 sockets
- 54 drive tools
- 275 wrenches (53 full polish)
- 61 screwdrivers
- 216 specialty tools

Separate prices total \$6,734.99.
009-35997 ..Set 3,799.95

COMBINE THE MODULES WITH STORAGE OPTIONS AND SAVE MORE!

SAVE \$30

Module 1 (300-piece Professional Tool Set) with 10-Drawer Ball-Bearing Combo. Separate prices total \$949.97.
009-93301N♦.....Combo 919.97

SAVE \$50

Modules 1 & 2 Combined (a 498-piece Professional Tool Set) with 10-Drawer Ball-Bearing Combo. Separate prices total \$1,749.96.
009-93302N♦.....Combo 1,699.96

SAVE \$70

Modules 1, 2 & 3 Combined (a 687-piece Professional Tool Set) with 10-Drawer Ball-Bearing Combo. Separate prices total \$2,549.95.
009-34679N♦.....Combo 2,479.95

SAVE \$80

Modules 1, 2, 3 & 4 Combined (a 891-piece Professional Tool Set) with 10-Drawer Ball-Bearing Combo. Separate prices total \$3,449.94.
009-93303N♦.....Combo 3,369.94

SAVE \$100

Modules 1, 2, 3, 4 & 5 Combined (a 997-piece Professional Tool Set) with 11-Drawer Ball-Bearing GRIPLATCH® Combo. Separate prices total \$4,699.93.
009-93304N♦.....Combo 4,599.93



TOOL COLLECTION WITH NO DUPLICATION

89-piece access expansion set

- 11 DRIVE TOOLS
- 51 WRENCHES (47 FULL POLISH)
- 14 PROFESSIONAL PLIERS
- 13 SPECIALTY TOOLS

When speed and access are required, this set delivers. Featuring professional pliers, full polish stubby wrenches and deep offset wrenches. See chart on pg. 38 for tools. Made in USA. Wt. 45 lbs.

Separate prices total \$1,135.12
009-35086Set 899.99

83-piece full polish ratcheting set

- 3 DRIVE TOOLS
- 64 RATCHETING WRENCHES
- 16 WRENCH SOCKETS

Introducing the dream team of full polish ratcheting wrenches. This set is the perfect addition to your growing professional tool collection. See chart on pg. 39 for tools. Made in USA. Wt. 24.9 lbs.

Separate prices total \$1,285.69
009-35183Set 849.99

77-piece large heavy-duty set

- 39 3/4-IN. SQ. DRIVE SOCKETS
- 7 DRIVE TOOLS
- 25 WRENCHES
- 6 SPECIALTY TOOLS

This impressive set cuts just about any big job down to size. See chart on pg. 40 for tools. Made in USA. Wt. 110 lbs.

Separate prices total \$1,738.73
009-35079Set 899.99

92-piece auto specialty set

- 19 BRAKE TOOLS
- 43 ENGINE TOOLS
- 13 TUNE UP/TESTING TOOLS
- 8 BATTERY, HOSE, PIPE AND STEERING TOOLS
- 9 SPECIALTY TOOLS

This set includes specialized tools to work on everything from brakes and shocks to electrical systems and radiators. See chart on pg. 40 for tools. Wt. 72.5 lbs.

Separate prices total \$1,149.40
009-83050Set 999.99

130-piece impact set

- 120 SOCKETS (34 SWIVEL SOCKETS)
- 10 DRIVE TOOLS

A complete set of Craftsman impact sockets, including the new "pinless" swivel impact sockets. Also includes powerful professional 1/2-inch impact gun driver. See chart on pg. 41 for tools. Wt. 53.8 lbs.

Separate prices total \$2,019.00
009-34130Set 1,299.99

page 38



page 39



page 40



page 40



page 41



modules 1+2+3+4+5+6 combined

- 1,086-piece
- 391 sockets
- 65 drive tools
- 326 wrenches (100 full polish)
- 61 screwdrivers
- 243 specialty tools

Separate prices total \$7,870.11.
009-33091 ..Set 4,699.94

modules 1+2+3+4+5+6+7 combined

- 1,169-piece
- 407 sockets
- 68 drive tools
- 390 wrenches (164 full polish)
- 61 screwdrivers
- 243 specialty tools

Separate prices total \$9,155.80.
009-35184 ..Set 5,549.93

modules 1+2+3+4+5+6+7+8 combined

- 1,246-piece
- 446 sockets
- 75 drive tools
- 415 wrenches (164 full polish)
- 61 screwdrivers
- 249 specialty tools

Separate prices total \$10,894.53.
009-33093 ..Set 6,449.92

modules 1+2+3+4+5+6+7+8+9 combined

- 1,338-piece
- 446 sockets
- 75 drive tools
- 415 wrenches (164 full polish)
- 61 screwdrivers
- 249 specialty tools
- 92 auto specialty tools

Separate prices total \$12,043.93.
009-93298Set 7,449.91

all modules 1 thru 10 combined

- 1,468-piece
- 566 sockets
- 85 drive tools
- 415 wrenches (164 full polish)
- 61 screwdrivers
- 249 specialty tools
- 92 auto specialty tools

Separate prices total \$14,062.93.
009-93299Set 8,749.90

A CRAFTSMAN TOOL CATALOG/ONLINE EXCLUSIVE

SAVE \$120

Modules 1, 2, 3, 4, 5 & 6 Combined (a 1,086-piece Professional Tool Set) with 14-Drawer Ball-Bearing GRIPLATCH® Combo. Separate prices total \$5,599.92.
009-93305N♦ ..Combo 5,479.92

SAVE \$140

Modules 1, 2, 3, 4, 5, 6 & 7 Combined (a 1,169-piece Professional Tool Set) with 14-Drawer Ball-Bearing GRIPLATCH® Combo. Separate prices total \$6,149.91.
009-93306N♦ ..Combo 6,009.91

SAVE \$170

Modules 1, 2, 3, 4, 5, 6, 7 & 8 Combined (a 1,246-piece Professional Tool Set) with 40-inch 19-Drawer Ball-Bearing Combo. Separate prices total \$7,449.90.
009-93307N♦Combo 7,279.90

SAVE \$200

Modules 1, 2, 3, 4, 5, 6, 7, 8 & 9 Combined (a 1,338-piece Professional Tool Set) with 40-inch 19-Drawer Ball-Bearing Combo. Separate prices total \$8,449.89.
009-93308N♦Combo 8,249.89

SAVE \$250

Modules 1 thru 10 Combined (a 1,468-piece Professional Tool Set) with 13-Drawer Craftsman AXS™ Combo. Separate prices total \$9,949.88.
009-93300N♦Combo 9,699.88

*Warranted, see page 94a.
♦ See "N" suffix note on page 94a.

THE 1,468-PIECE ULTIMATE MECHANIC'S TOOL COLLECTION

INCLUDES ALL MODULES 1 THRU 10



A. OVER \$14,000 VALUE

MODULES 1 THRU 10 MECHANIC'S TOOL COLLECTION

Catalog/Online EXCLUSIVE

A. Craftsman 1,468-piece Professional Tool Set – Modules 1, 2, 3, 4, 5, 6, 7, 8, 9 & 10. The ultimate set, with over 1,400 pieces, means you're ready to tackle almost any job. Separate prices total \$14,062.93. See charts on pages 35-41 for tools. Wt. 571.4 lbs.

009-93299
MODULES 1-10... 8,749.90

- 566 sockets
- 85 drive tools
- 415 wrenches (164 full polish)
- 19 pliers
- 61 screwdrivers (19 professional)
- 239 specialty tools
- 19 brake tools
- 40 engine tools
- 13 tune up/testing tools
- 8 battery, hose, pipe and steering tools

STORAGE OPTION

Catalog/Online EXCLUSIVE

B. NEW Craftsman 41-inch Wide 16-Drawer Stainless Steel Combo. Provides 26,879 cu. in. of storage. See 009-10595 and 009-10600 on page 11 for more details. Wt. 341 lbs.

009-93230N ♦1,199.88

SAVE \$250

The Ultimate Collection with Stainless Steel Craftsman Storage. Combines "A", 1,468-piece Professional Tool Set (Modules 1-10) with "B", 41-inch 16-Drawer Craftsman Stainless Steel Combo.

Separate prices total \$9,949.88. Wt. 912.4 lbs. 009-93300N ♦

Combo 9,699.88



MECHANIC'S TOOL SET MODULE 1

BRING THE TOOLS THAT NASCAR® COUNTS ON INTO YOUR OWN GARAGE. CHECK IT OUT AT craftsman.com/officialtools



MODULE 1

- 168 sockets • 19 drive tools
- 53 wrenches • 6 screwdrivers
- 54 specialty tools

C. Craftsman Professional 300-piece Starter Set. Separate prices total \$1,502.28. Made in USA. Guaranteed Forever!® Wt. 60.5 lbs.

009-33300... \$599.99

- 1/4-IN. SQ. DRIVE SOCKETS**
- 11 6-pt. inch (5/32 thru 9/16 in.)
 - 12 6-pt. metric (4, 5, 5.5, 6 thru 14 mm)
 - 10 6-pt. inch deep (3/16 thru 9/16 in.)
 - 11 6-pt. metric deep (4 thru 14 mm)
 - 3 Torx® bit sockets (T-15, T-20, T-25)
 - 3 Extension bars (1 1/2, 3 and 6 in.)
 - 1 ea. Quick-release ratchet, 3/8-in. adapter, 6 in. spinner handle
- 3/8-IN. SQ. DRIVE SOCKETS**
- 5 8-pt. inch (1/4 thru 1/2 in.)
 - 10 12-pt. inch (5/16 thru 7/8 in.)
 - 12 12-pt. metric (9 thru 19, 21 mm)
 - 11 6-pt. inch deep (3/8 thru 1 in.)
 - 11 6-pt. metric deep (9 thru 19 mm)
 - 4 Torx® bit sockets (T-30, T-40, T-45, T-50)
 - 2 Spark plug sockets (5/8 and 13/16 in.)
 - 2 Adapters (1/4 and 1/2 in.)
 - 4 Extension bars (1 1/2, 3, 6 and 10 in.)
 - 1 Quick-release long ratchet
- 1/2-IN. SQ. DRIVE SOCKETS**
- 6 8-pt. inch (7/16 thru 3/4 in.)
 - 18 12-pt. inch (3/8 thru 1 1/4 in.)
 - 22 12-pt. metric (9 thru 28, 30, 32 mm)
 - 9 12-pt. inch deep (1/2 thru 1 in.)
 - 11 12-pt. metric deep (13 thru 22, 24 mm)
 - 4 Extension bars (2, 3, 6 and 10 in.)
 - 1 ea. Quick-release ratchet, 3/8-in. adapter
- WRENCHES**
- 32 Combination: 15 inch (1/4 thru 1 1/8 in.); 17 metric (6 thru 22 mm)
 - 12 Open-end: 6 inch (1/4 x 5/16 thru 3/4 x 7/8 in.); 6 metric (6 x 8 thru 16 x 18 mm)
 - 9 Flare nut: 4 inch (3/8 x 7/16 thru 3/4 x 7/8 in.); 5 metric (9 x 11 thru 19 x 21 mm)
- SPECIALTY TOOLS**
- 6 Screwdrivers: 3 Phillips (#1, #2, #3); 3 slotted (1/8 x 4, 3/16 x 4, 1/4 x 6 in.)
 - 14 Nut drivers: 7 inch (3/16 thru 1/2 in.), 7 metric (5 thru 11 mm)
 - 40-pc. Hex key set: 20 inch, 20 metric

300-PIECE STARTER SET



C. OVER \$1,500 VALUE INCLUDES 53 ASSORTED WRENCHES



SAVE MORE GET THE COMBO

MODULE 1 WITH STORAGE OPTION SAVE \$30
 Module 1, "C" (a 300-piece Professional Tool Set), Combined with "D", 10-Drawer Ball-Bearing Combo.
 Separate prices total \$949.97. Wt. 228.5 lbs.
 009-93301N◆
Combo 919.97

MORE TO EXPLORE
 >> at sears.com!

STORAGE OPTION
Catalog/Online EXCLUSIVE
D. Craftsman 10-Drawer Ball-Bearing Combo in Red. 11,971 cu. in. of storage. See 009-87732 and 009-87734 on page 16 for more details. Wt. 168 lbs.
 009-94691N◆ **349.98**

*Warranted, see page 94a.
 ◆ See "N" suffix note on page 94a.

A. OVER \$1,330 VALUE

198-PIECE SET



MODULE 2 198-PIECE EXPANSION SET

- 84 sockets • 8 drive tools • 60 wrenches • 9 screwdrivers • 37 specialty tools

A. Craftsman 198-piece Expansion Set Module 2. Separate prices total \$1,339.89. Made in USA. Guaranteed Forever!® Wt. 50.9 lbs.

009-33198...699.99

1/4-IN. SQ. DRIVE SOCKETS

- 10 12-pt. inch (3/16 thru 9/16 in.)
- 10 12-pt. inch deep (3/16 thru 9/16 in.)
- 4 Screwdriver bits: (7/32, 1/4); 2 Phillips (P-1, P-2)
- 5 Hex bits: (3/16 thru 3/8 in.)
- 1 ea. 6-inch flex T-handle, 14-inch extension bar, 1/4-inch flex extension, 15-inch speeder bar, universal joint

3/8-IN. SQ. DRIVE SOCKETS

- 13 6-pt. inch (1/4 thru 1 in.)
- 17 6-pt. metric (6 thru 22 mm)
- 7 Screwdriver bits: (7/32, 9/32, 3/8); 4 Phillips (#1, #2, #3, #4)
- 6 Inch hex bits (5/32 thru 3/8 in.)
- 6 Metric hex bits (4 thru 8, 10 mm)
- 2 Spark plug sockets (3/4 in., 18 mm)
- 1 ea. 10-inch flex T-handle, 20-inch ext. bar, universal joint

WRENCHES

- 28 Combination 6-pt. wrenches: 14 inch (1/4 thru 1 in.); 14 metric (6 thru 19 mm)
- 9 Open-end: 4 inch (19/32 x 11/16, 25/32 x 13/16, 11/16 x 13/16, 15/16 x 1 in.); 5 metric (17 x 19 thru 24 x 26 mm)

WRENCHES (cont'd)

- 3 Short box-end: (3/8 x 7/16, 1/2 x 9/16, 5/8 x 3/4 in.)
- 3 Adjustable wrenches (6, 8 and 10 in.)
- 17 Ratcheting: 8 inch (5/16 thru 3/4); 9 metric (8, 10-15, 18 and 19)

1/2-IN. SQ. DRIVE HEX BITS

- 2 Inch hex bits (9/16, 5/8)
- 2 Metric hex bits (14, 17 mm)

SPECIALTY TOOLS

- 3 Folding hex key sets (inch, metric and Torx®)
- 9 Screwdrivers: 6 slotted (3/32 x 1 1/2 mini, 1/4 x 1 1/2 stubby, 1/8 x 2, 3/16 x 6, 1/4 x 8 and 5/16 x 8); 3 Phillips (#0 x 2 1/2, #4 and #2 x 1 1/2)
- 3 Hammers: 12-oz. ball pein, 12-oz. plastic tip, 16-oz. rubber mallet
- 20-pc. Punch and chisel set
- 4 Pliers: long needle nose, slip joint, arc joint & diagonal cutting
- 1 Pair of protective goggles
- 6 Socket racks

MODULES 1 & 2 WITH STORAGE OPTION

SAVE \$50
Modules 1 & 2 Combined (a 498-piece Professional Tool Set), with "C", 10-Drawer Ball-Bearing Combo.

Separate prices total \$1,749.96. Wt. 308.4 lbs.
009-93302N◆
Combo 1,699.96

MODULES 1 & 2
Catalog/Online EXCLUSIVE
498-piece Professional Tool Set
Modules 1 & 2 Combined.

Contains tools to cover most essential applications. Separate prices total \$2,842.17. Made in USA. Guaranteed Forever!® Wt. 111.4 lbs.

009-33498Set 1,299.98



MODULE 3 189-PIECE SPECIALIZED EXPANSION SET

- 102 sockets • 10 drive tools • 39 wrenches • 5 pliers • 14 screwdrivers • 19 specialty tools

B. Craftsman 189-piece Specialized Expansion Set Module 3. Separate prices total \$1,492.17. Made in USA. Guaranteed Forever!® Wt. 70.8 lbs.

009-35189...799.99

1/4-IN. SQ. DRIVE SOCKETS

- 3 External Torx® (E6, E7, E8)

3/8-IN. SQ. DRIVE SOCKETS

- 3 12-pt. inch (1/4, 15/16, 1 in.)
- 3 12-pt. metric (6 thru 8 mm.)
- 11 12-pt. inch deep (3/8 thru 1 in.)
- 13 12-pt. metric deep (9 thru 19, 21, 22 mm)
- 4 External Torx® (E10, E12, E14, E16)
- 1 ea. Quick-release flex ratchet, 7-inch slide bar, 16-inch speeder bar

1/2-IN. SQ. DRIVE SOCKETS

- 15 6-pt. inch (3/8 thru 1 1/4 in.)
- 14 6-pt. metric (9 thru 22 mm)
- 1 12-pt. inch (1 1/2 in.)
- 2 12-pt. metric (29, 36 mm)
- 11 6-pt. inch deep (1/2 thru 1 1/8 in.)
- 9 6-pt. metric deep (12 thru 19, 21 mm)
- 3 12-pt. inch deep (7/16, 1 1/16, 1 1/8 in.)
- 4 12-pt. metric deep (10 thru 12, 27 mm)
- 4 Drag link sockets (9/16, 3/4, 15/16 and 1 3/16 in.)
- 2 Spark plug sockets (5/8 and 13/16 in.)
- 2 Flex T-handles (15 and 18 in.)

1/2-IN. SQ. DRIVE SOCKETS (cont'd)

- 1 ea. Quick-release flex ratchet, universal joint, 9-inch slide bar, 20-inch extension bar, 18-inch speeder bar

WRENCHES

- 20 Box-end wrenches: 10 inch (1/4 x 5/16 thru 15/16 x 1 in.); 10 metric (6 x 8 thru 22 x 24 mm)
- 6 Extreme grip wrenches: 3 inch (7/16 x 1/2 thru 11/16 x 3/4); 3 metric (12 x 13 thru 17 x 19)
- 5 Tappet wrench: inch (3/8 x 7/16 thru 3/4 x 7/8)
- 8 Box-end ratcheting wrenches: 4 inch (5/16 x 3/8 - 11/16 x 3/4); 4 metric (8 x 10 - 18 x 19 mm)

SPECIALTY TOOLS

- 14 Screwdrivers: 6 slotted (5/16 x 1 3/4, 1/4 x 4, 15/16 x 6, 3/16 x 9, 1/4 x 12, 3/8 x 12); 2 Phillips (#2 x 8, #0 x 1 1/2); 6 Torx® (T-10, T-15, T-20, T-25, T-27, T-30)
- 5 Pliers: 8-inch slip joint, 9 1/2-inch arc joint, 8-inch duckbill, 8-inch long reach, 7-inch bent wide jaw
- 10 T-handle inch hex keys
- 8 T-handle metric hex keys
- 1 16-oz. ball pein hammer

B. OVER \$1,490 VALUE

189-PIECE SET



SAVE MORE GET THE COMBO

STORAGE OPTION

Catalog/Online EXCLUSIVE
C. Craftsman 10-Drawer Ball-Bearing Combo in Midnight Blue. 14,549 cu. in. of storage. See 009-61812 and 009-61816 on page 16 for details. Wt. 197 lbs.
009-61802N◆449.98

MODULES 1 THRU 3 WITH STORAGE OPTION

SAVE \$70
Modules 1, 2 & 3 Combined (a 687-piece Professional Tool Set), with "C", 10-Drawer Ball-Bearing Combo.

Separate prices total \$2,549.95. Wt. 379.2 lbs.
009-34679N◆
Combo 2,479.95

MODULES 1 THRU 3

Catalog/Online EXCLUSIVE
687-piece Professional Tool Set
Modules 1, 2 & 3 Combined. Separate prices total \$4,334.34. Made in USA. Guaranteed Forever!® Wt. 182.2 lbs.
009-34678Set 2,099.97

MECHANIC'S TOOL MODULES 2, 3, & 4

BRING THE TOOLS THAT NASCAR® COUNTS ON INTO YOUR OWN GARAGE. CHECK IT OUT AT craftsman.com/officialtools

CRAFTSMAN®

OFFICIAL TOOLS OF 

MODULE 4

- 37 flex sockets • 8 drive tools
- 67 wrenches • 10 screwdrivers
- 82 specialty tools

D. Craftsman 204-Piece Access Set Module 4. Separate prices total \$1,060.45. Guaranteed Forever!® Wt. 32 lbs..

009-33204... **799.99**

1/4-IN. SQ. DRIVE SOCKETS

- 8 6-pt. inch flex (3/16 thru 9/16 in.)
- 10 6-pt. metric flex (5 thru 44 mm)
- 1 ea. Full polish ratchet, 4 1/2-inch extension socket, 4 1/2-inch slide bar and flex spinner

3/8-IN. SQ. DRIVE SOCKETS

- 7 6-pt. inch flex (3/8 thru 3/4 in.)
- 10 6-pt. metric flex (10 thru 19 mm)
- 2 Flex spark plug sockets (5/8 thru 3/16 in.)
- 1 Full polish ratchet
- 1 Full polish extra long ratchet

1/2-IN. SQ. DRIVE

- 1 Full polish ratchet
- 1 15-inch slide bar

WRENCHES

- 10-pc. Combination ignition, inch set
- 10-pc. Combination ignition, metric set
- 16-pc. Open end ignition set: 8 inch, 8 metric
- 8-pc. Box ignition: 4 inch, 4 metric
- 1 4-inch adjustable wrench
- 1 Obstruction wrench
- 21 Crowfoot wrenches: 11 inch (3/8 thru 1 in.), 10 metric (10 thru 19 mm)

SPECIALTY TOOLS

- 26-pc. Ball end hex key set: 13 inch, 13 metric
- 11-pc. Ball end T-handle hex key set: 5 inch (1/8 thru 1/4 in.), 6 metric (3 thru 6, 8, 10 mm)
- 12-pc. Nut driver bit set: 7 inch, 5 metric
- 10-pc. Screwdriver bit set
- 3 Phillips screw-holding: (#1 x 4, #2 x 5, starter)
- 7-pc. Reverse ratcheting screwdriver bit set
- 4 Pliers: 7 and 10-inch pro straight jaw locking; 7 and 10-inch Knipex adjustable
- 6-pc. Mini pliers set: 5-inch needle nose, 4 1/2-inch long and bent needle nose, 4 1/2-inch end nipper, 4-inch diagonal and wide jaw diagonal cutting pliers
- 6 Files: 6-in. round bastard, 8 and 10-in. half-round bastard, 5-in. ignition, 10-in. mill and 4-in. extra slim taper file
- 3-pc. Socket cap set
- 1 ea. Magnetic handle, cotter key extractor, scratch awl, 16-inch rolling wedge bar

204-PIECE ACCESS SET



D. OVER \$1,000 VALUE



E NEW

**SAVE MORE
GET THE COMBO**

**MODULES 1
THRU 4 WITH
STORAGE
OPTION**

SAVE \$80

Modules 1 thru 4 Combined (a 891-piece Professional Tool Set), with "E", 12-Drawer Ball-Bearing Combo.

Separate prices total \$3,449.94. Wt. 447.2 lbs.
009-93303N◆
Combo 3,369.94

STORAGE OPTION

Catalog/Online EXCLUSIVE
E. NEW Craftsman 12-Drawer Ball-Bearing Combo in Platinum/Black. 14,491 cu. in. of storage. See 009-82578 and 009-82580 on page 17 for details. Wt. 233 lbs.

009-93317N◆ **549.98**

MODULES 1 THRU 4 WITH STORAGE OPTION

Catalog/Online EXCLUSIVE
891-piece Professional Tool Set Modules 1, 2, 3 & 4 Combined. Separate prices total \$5,394.79. Wt. 214.2 lbs.

009-33891 **Set 2,899.96**

*Warranted, see page 94a.
◆ See "N" suffix note on page 94a.

A. OVER \$1,340 VALUE

106-PIECE SET



MODULE 5 106-PIECE ADVANCED SET

- 9 drive tools • 56 wrenches (53 full polish) • 22 professional screwdrivers • 19 specialty tools

A. Craftsman 106-piece Advanced Set

Separate prices total \$1,340.20. Made in USA. Guaranteed Forever!® Wt. 51 lbs.

009-35106... 899.99

DRIVE TOOLS

- 3 Thin profile ratchets (1/4, 3/8, 1/2 in.)
- 3 1/4-inch quick release extension bars (3, 6 and 10 in.)
- 3 3/8-inch quick release extension bars (3, 6 and 10 in.)

PROFESSIONAL WRENCHES

- 18 Full polish inch combination (1/4 thru 1 1/2 in.)
- 19 Full polish metric combination (7 thru 19, 21 thru 25, 30 mm)
- 16 Cross-Force™ full polish combination: 8 inch (5/16 thru 3/4 in.); 8 metric (8, 10, 12 thru 15, 17, 18 mm)
- 3 Professional beak jaw adjustable wrenches (6, 8 and 10 in.)

PROFESSIONAL SCREWDRIVERS

- 6 Pro Phillips (#0 x 3, #1 x 4, #2 x 4, #2 x 2 1/4, #3 x 6 and #4 x 8 in.)
- 10 Pro slotted (1/8 x 3, 3/16 x 4, 3/16 x 6, 1/4 x 2 1/4, 1/4 x 4, 1/4 x 6, 1/4 x 8, 5/16 x 6, 5/16 x 8, 3/8 x 8)
- 6 Pro Torx® (T-10, T-15, T-20, T-25, T-27, T-30)

SPECIALTY TOOLS

- 14 T-through handle hex keys (7-inch (3/32 thru 1/4-in.); 7 metric (2.5, 3 thru 6, 8, 10 mm))
- 5 Pro pry bars (10, 12, 17, 25 and 31 in.)

MODULES 1 THRU 5 COMBINED

Catalog/Online EXCLUSIVE
997-piece Professional Tool Set Modules 1, 2, 3, 4 & 5 Combined. Separate prices total \$6,734.99. Wt. 265.2 lbs.
009-35997.....Set 3,799.95

MODULES 1 THRU 5 WITH STORAGE OPTION SAVE \$100

Modules 1 thru 5 Combined (a 997-piece Professional Tool Set), with "C", 14-Drawer GRIPLATCH® Ball-Bearing Combo.

Separate prices total \$4,649.93. Wt. 527.2 lbs.
009-93304N◆
Combo 4,549.93



MODULE 6 89-PIECE ACCESS EXPANSION SET

- 11 drive tools • 51 wrenches (47 full polish)
- 14 professional pliers • 13 specialty tools

B. Craftsman 89-piece Access Expansion Set

Separate prices total \$1,135.12. Made in USA. Guaranteed Forever!® Wt. 45 lbs.

009-35086... 899.99

DRIVE TOOLS

- 1 1/4-in. thumb wheel ratchet,
- 1 1/4-in. wobble extension bar (1 1/2 in.)
- 2 3/8-in. full polish ratchets (stubby flex, ergo flex)
- 1 3/8-in. thumb wheel ratchet
- 3 3/8-in. wobble extension bars (1 1/2, 3, 6 in.)
- 1 1/2-in. wobble extension bar (2 in.)
- 2 Microtorq® torque wrenches (3/8 and 1/2 in.)

PROFESSIONAL WRENCHES

- 12 Full polish inch stubby combination (5/16 thru 1 in.)
- 13 Full polish metric stubby combination (9, 10, 12 thru 22 mm)
- 4 Professional adjustable wrenches (6, 8, 10 and 12 in.)

PROFESSIONAL WRENCHES (cont'd)

- 10 Full polish flare nut wrenches; 5 inch (1/4 x 5/16 thru 3/4 x 7/8 in.); 5 metric (9 x 11 thru 16 x 18 mm)
- 12 Full polish deep offset wrenches; 5 inch (3/8 x 7/16 thru 13/16 x 15/16 in.); 7 metric (10 x 11 thru 21 x 23 mm)

PROFESSIONAL PLIERS

- 5 Pro pliers (6-3/4 in. slip joint, 9 1/2 in. arc joint, 8 in. long nose, 7 in. wide jaw diagonal, 6 in. diagonal)
- 4 Pro locking pliers (6-inch long nose; 5, 7, 10-inch curve jaw)
- 1 ea. Dual Romex cable up-front stripper/cutter, wire stripper/pliers
- 3 Up-front mini wire cutter/stripper/crimper

SPECIALTY TOOLS

- 3-pc. Screw-Out® damaged screw remover set
- 10-pc. Bolt-Out® set

B. OVER \$1,135 VALUE

89-PIECE SET



C SAVE MORE GET THE COMBO

MODULES 1 THRU 6 WITH STORAGE OPTION SAVE \$120

Modules 1 thru 6 Combined (a 1,086-piece Professional Tool Set), with "C", 14-Drawer GRIPLATCH® Ball-Bearing Combo.

Separate prices total \$5,549.92. Wt. 572.2 lbs.
009-93305N◆
Combo 5,429.92

STORAGE OPTION

Catalog/Online EXCLUSIVE
C. Craftsman 14-Drawer Ball-Bearing GRIPLATCH® Chest and Rollaway Combo in Black. 17,489 cu. in. of storage. See 009-59618 and 009-59619 on page 14 for details. Wt. 262 lbs.
009-93265N◆ 849.98

MODULES 1 THRU 6 COMBINED

Catalog/Online EXCLUSIVE
1,086-piece Professional Tool Set Modules 1, 2, 3, 4, 5 & 6 Combined. Separate prices total \$7,870.11. Wt. 310.2 lbs.
009-33091.....Set 4,699.94

MECHANIC'S TOOL SET MODULES 5, 6 & 7

BRING THE TOOLS THAT NASCAR® COUNTS ON INTO YOUR OWN GARAGE. CHECK IT OUT AT craftsman.com/officialtools



MODULE 7

- 3 drive tools • 64 ratcheting wrenches
- 16 wrench sockets

D. Craftsman 83-piece Full Polish Ratcheting Set. Separate prices total \$1,285.69. Made in USA. Guaranteed Forever!® See chart for tools. Wt. 24.9 lbs.

009-35183...849.99

RATCHETING WRENCHES

- 16 Full polish ratcheting wrenches
8 inch: (5/16 thru 3/4 in.)
8 metric: (8, 10, 12 thru 15, 17, 18 mm)
- 20 Reversible ratcheting wrenches
8 inch: (5/16 thru 3/4 in.)
12 metric: (8 thru 19 mm)
- 14 Locking flex ratcheting wrenches
7 inch: (5/16 thru 3/4 in.)
7 metric: (8, 10, 12, 13, 15, 17, 19 mm)
- 14 Stubby locking flex ratcheting wrenches
7 inch: (5/16 thru 3/4 in.)
7 metric: (8, 10, 12, 13, 15, 17, 19 mm)

GEAR SOCKETS

- 16 Wrench sockets
8 inch: (5/16 thru 3/4 in.)
8 metric: (8, 10, 12, 13, 14, 15, 17, 18 mm)
- 1 ea. Ratchet driver handle, 4 in. and 6 in. ratchet driver fixed shafts

83-PIECE FULL POLISH RATCHETING SET



CUSTOMER review

“These wrenches are GREAT! Easy to use and a must for any mechanic. Once you get a set EVERYONE will want to use them.”

deanandvickie
South Carolina

D. OVER \$1,285 VALUE INCLUDES LOCKING FLEX WRENCHES

E
SAVE MORE
GET THE COMBO

MODULES 1 THRU 7 WITH STORAGE OPTION

SAVE \$150
Modules 1 thru 7 Combined (a 1,169-piece Professional Tool Set), with “E”, 11-Drawer Ball-Bearing GRIPLATCH® Combo.

Separate prices total \$6,149.91. Wt. 543.6 lbs.
009-93306N◆
Combo 5,999.91

STORAGE OPTION

Catalog/Online EXCLUSIVE
E. Craftsman 11-Drawer Ball-Bearing GRIPLATCH® Combo in Midnight Blue. 14,491 cu. in. of storage. See 009-59891 and 009-59892 on page 14 for details. Wt. 209 lbs.
009-93261N◆599.98

MODULES 1 THRU 7 COMBINED

Catalog/Online EXCLUSIVE
1,169-piece Professional Tool Set Modules 1, 2, 3, 4, 5, 6 & 7 Combined. Separate prices total \$9,155.80. Wt. 335.1 lbs.
009-35184Set 5,549.93



*Warranted, see page 94a.
◆ See “N” suffix note on page 94a.

A. OVER \$1,730 VALUE

77-PIECE SET



MODULE 8 77-PIECE LARGE HEAVY-DUTY SET

• 39 3/4-inch drive sockets • 7 drive tools • 25 wrenches • 6 specialty tools
A. Craftsman 77-piece Large Heavy-Duty Set Module 8.
 Separate prices total \$1,738.73. Made in USA.
 Guaranteed Forever!® Wt. 110 lbs.
009-35079... 899.99

3/4-IN. SQ. DRIVE SOCKETS

- 21 12-pt. dual-marked inch sockets: (7/8 thru 2 3/8 in.)
- 18 12-pt. laser + stamp metric sockets: (19 thru 30, 32, 35, 36, 38, 41, 42 mm)
- 3 Extension bars (5, 8 and 16 in.)
- 1 ea. Quick release ratchet, 18-inch flex T-handle and 18-inch slide bar
- 1 1/2-inch drive 3/4-inch adapter

WRENCHES

- 3 Combination inch wrenches (1 1/16, 1 1/4, and 1 5/16 in.)
- 8 Combination metric wrenches (23 thru 28, 30, 32 mm)
- 4 Open end inch wrenches: (1 1/16 x 1 1/8, 1 1/4 x 1 5/16, 1 3/8 x 1 7/16, 1 1/2 x 1 5/8 in.)

WRENCHES (cont'd)

- 3 Open-end metric wrenches (25 x 27, 28 x 30, 30 x 32 mm)
- 2 Box-end standard wrenches: (1 1/16 x 1 1/4, 1 1/8 x 1 5/16 in.)
- 4 Box-end metric wrenches (24 x 26, 25 x 28, 27 x 30, 28 x 32 mm)
- 1 12-inch adjustable wrench

SPECIALTY TOOLS

- 2 Short hex keys metric (12 and 17 mm)
- 1 ea. 10-inch slip joint pliers, 13-inch arc-joint pliers, 32-ounce ball peen hammer, 48-ounce double faced engineer hammer

MODULE 1 THRU 8 COMBINED

Catalog/Online EXCLUSIVE
1,246-piece Professional Tool Set Modules 1, 2, 3, 4, 5, 6, 7 and 8 Combined. This set cuts just about any big job down to size. Separate prices total \$10,894.53. Made in USA. Guaranteed Forever!® Wt. 445.1 lbs.
009-33093... Set 6,449.92

MODULES 1 THRU 8 WITH STORAGE OPTION SAVE \$170

Modules 1 thru 8 Combined. (a 1,246-piece Professional Tool Set), with "C", 22-Drawer Ball-Bearing Combo

Separate prices total \$7,449.90. Wt. 830.1 lbs.
000-93307N
Combo 7,279.90



MODULE 9 92-PIECE AUTO SPECIALTY SET

- 19 brake tools • 43 engine tools • 13 tune-up and testing tools
- 8 battery, hose, pipe and steering tools
- 9 specialty tools

B. NEW Craftsman 92-piece Auto Specialty Set Module 9.
 Separate prices total \$1,149.40. See chart for tools. Wt. 72.5 lbs.

009-83050... 999.99

BRAKE TOOLS

- 11 Torx® bits (T-15, 20, 25, 27, 30, 40, 45, 47, 50, 55, 60)
- 1 Brake adjusting tool
- 1 ea. Brake spring, brake pad, heavy-duty break pad spreader, brake cylinder hone, lock ring pliers, brake spring pliers, brake tool-shoe spring

ENGINE TOOLS

- 8-pc. Serpentine belt tool
- 6-pc. Impact driver set
- 2-pc. Wire cutter/stripper crimper set
- 4-pc. Hook and pick set
- 12-pc. Retaining ring pliers set
- 3-pc. Fan Clutch set
- 1 ea. Snap ring pliers, magnetic pick-up tool, 2 1/4-in. mirror, nut cracker, valve spring compressor, piston ring expander, gasket scraper, jaw gear puller set

TUNE-UP AND TESTING TOOLS

- 2 swivel oil filter wrenches
- 1 ea. Circuit tester, steel magnetic bowl, spark plug pliers, spark plug thread chaser, diagnostic tool, stethoscope, 5-in. ignition pliers, compression tester, multi-meter, timing light, 36-blade combination gauge

BATTERY, HOSE PIPE AND STEERING TOOLS

- 1 ea. Battery wrench, battery terminal wrench, pipe expander, hose clamp pliers, pipe wrench pliers, pinch-off hose pliers, steering wheel plate remover, steering wheel puller

SPECIALTY TOOLS

- 2 Curved pry bars (12 and 17 in.)
- 5-pc. Pickle fork kit
- 1 ea. Harmonic balancer, seal puller

B. OVER \$1,100 VALUE



92-PIECE SET

C NEW

SAVE MORE GET THE COMBO

STORAGE OPTION

Catalog/Online EXCLUSIVE
C. Craftsman 40-inch 22-Drawer Ball-Bearing Combo in Red. 25,796 cu. in. of storage. See 009-82550 and 009-82551 on page 17 for details. Wt. 385 lbs.
009-93287N... 999.98

MODULES 1 THRU 9 WITH STORAGE OPTION SAVE \$200

Modules 1 thru 9 Combined (a 1,338-piece Professional Tool Set), with "C", 22-Drawer Ball-Bearing Combo.

Separate prices total \$8,449.89. Wt. 902.6 lbs.
009-93308N
Combo 8,249.89

MODULES 1 THRU 9 COMBINED

1,338-piece Professional Tool Set Modules 1, 2, 3, 4, 5, 6, 7, 8 and 9 Combined.
 Separate prices total \$12,043.93. Wt. 517.6 lbs.
009-93298... Set 7,449.91

MECHANIC'S TOOL SET MODULES 8, 9 & 10

BRING THE TOOLS THAT NASCAR® COUNTS ON INTO YOUR OWN GARAGE. CHECK IT OUT AT craftsman.com/officialtools

CRAFTSMAN®

OFFICIAL TOOLS OF 

MODULE 10

- 120 sockets (34 swivel sockets)
- 10 drive tools

D. Craftsman 130-piece Impact Set Module 10. Separate prices total \$2,019.00. See chart below for tools. Wt. 53.8 lbs.

009-34130... **1,299.99**

1/2-IN. IMPACT DRIVE TOOLS

- 1 1/2 in. impact gun driver
- 3 Impact extension bars: (3, 6, 10 in.)
- 1 3/8 in. impact adapter
- 1 3/4 x 13/16 in. impact double end socket
- 1 Impact swivel universal joint

1/2-IN. 6-PT. IMPACT SOCKETS

- 12 6-pt. inch: (3/8 thru 1 1/16 in.)
- 12 6-pt. metric: (12 thru 19, 21, 22, 24, 27 mm)
- 12 6-pt. deep inch: (3/8 thru 1 1/16 in.)
- 12 6-pt. deep metric: (12 thru 19, 21, 22, 24, 27 mm)
- 9 6-pt. swivel impact inch: (1/2 thru 1 in.)
- 9 6-pt. swivel impact metric: (13 thru 19, 21, 22 mm)

3/8-IN. IMPACT DRIVE TOOLS

- 2 Impact extension bars: (3, 6 in.)
- 1 Impact swivel universal joint

3/8-IN. 6-PT. IMPACT SOCKETS

- 9 6-pt. inch: (1/4 thru 3/4 in.)
- 10 6-pt. metric: (10 thru 19 mm)
- 9 6-pt. inch deep: (1/4 thru 3/4 in.)
- 10 6-pt. metric deep: (10 thru 19 mm)
- 7 6-pt. swivel inch: (3/8 thru 3/4 in.)
- 9 6-pt. swivel metric: (10 thru 18 mm)

130-PIECE IMPACT SET



Refer to pages 122 and 123 for Craftsman 3/4 and 1-inch impact sockets!

D. OVER \$2,000 VALUE | INCLUDES 1/2-IN. DRIVE IMPACT WRENCH



SEARS.COM/SHOPTOOLS

Sign up to be notified when items go on sale.



**SAVE MORE
GET THE COMBO**

**MODULES
1 THRU 10
WITH STORAGE
OPTION**

SAVE \$250
Modules 1 thru 10 Combined (a 1,468-piece Professional Tool Set), with "E", 41-inch 16-Drawer Stainless Steel Combo.

Separate prices total \$9,949.88. Wt. 912.4 lbs.
009-93300N◆

Combo 9,699.88

STORAGE OPTION

Catalog/Online EXCLUSIVE
E. Craftsman 41-inch Wide 16-Drawer Stainless Steel Combo
Provides 26,879 cu. in. of storage. See 009-10595 and 009-10600 on page 11 for more details. Wt. 341 lbs.
009-93230N◆ **1,199.98**

MODULES 1 THRU 10 COMBINED

Catalog/Online EXCLUSIVE
1,468-piece Professional Tool Set Modules 1, 2, 3, 4, 5, 6, 7, 8, 9 & 10.
The ultimate set, with over 1,468 pieces, means your ready to tackle almost any job. Separate prices total \$14,062.93. Wt. 571.4 lbs.
009-93299 **Set 8,749.90**

*Warranted, see page 94a.
◆ See "N" suffix note on page 94a.



EXCLUSIVE INNOVATIVE MTS SET

MODULE 11

- 24 wrenches
- 14 T-Handle nut drivers
- 11 T-through Torx® drivers
- 3 Professional Pliers
- 6 Specialty tools
- 4 Torx® bit sockets

A. NEW Craftsman 62-piece Innovation Pro Set. Separate prices total \$1,143.69. Guaranteed Forever!® Wt. 39.3 lbs..

009-83051...799.99

CROSS-FORCE COMBINATION WRENCHES

- 12 Inch (3/8 thru 1 1/8-in.)
- 12 Metric (10 thru 24 mm)

T-HANDLE NUT DRIVERS

- 7 Metric (5 thru 11 mm)
- 7 Inch (3/16 thru 1/2-in.)

T-THROUGH TORX® DRIVERS

- 11 T-8, 9, 10, 15, 20, 25, 27, 30, 40, 45, 50

PROFESSIONAL PLIERS

- 2 Pro Slip Joint Long Nose Pliers (8 & 10-in.)
- 1 Pro Arc Joint Pliers (9-in.)

SPECIALTY TOOLS

- 4 2 3/8-in. Drive Torx® Bit Sockets (T-27, T-47)
- 2 1/2-in. Drive Torx® Bit Sockets (T-55, T-60)
- 3 Locking Flex Pry Bars (8, 16, 24-in.)

FOLDING HEX KEY SETS

- 1 7-pc Blade Tamper Torx®
- 1 9-pc Blade Ball End Inch
- 1 7-pc Blade Ball End Metric

62-PIECE — INNOVATION PRO SET



A. OVER \$1,140 VALUE

SHOP ON THE GO!

Visit sears2go.com on your mobile device



STORAGE OPTION

Catalog/Online EXCLUSIVE
B. NEW Craftsman 14-Drawer Ball-Bearing GRIPLATCH® Combo in Forest Green. 17.489 cu. in. of storage. See 009-61980 and 009-61981 on page 14 for details. Wt. 262 lbs.
 009-93269N♦.....849.98

SAVE \$150

The Ultimate Collection with Craftsman Storage. Combines "A", 62-piece Innovation Pro Mechanic's Tool Set with "B", 14-Drawer Ball-Bearing GRIPLATCH® Combo.

Separate prices total \$1,649.97.

009-93309N♦

Combo 1,499.97



Catalog/Online EXCLUSIVE

A. Craftsman 62-piece Innovation Pro Mechanic's Tool Set. Set features some of the latest Craftsman innovations. Choose this set to complete your tool assortment without duplication. See above for a complete list of tools. Separate prices total \$1,143.69. Made in USA. Wt. 39.3 lbs.

009-83051
 MODULE 11799.99

COLLECTIBLE INSPIRATIONS

ORANGE COUNTY
CRAFTSMAN
CHOPPER
CUSTOM DESIGNED...

THE BIKE, THE WRENCH, THE BOX

COLLECTIBLE SETS

P Personalize it!

Look for the blue **P** symbol throughout the catalog for additional items that can be personalized — a great way to cleverly identify your tools!



ALL NEW



Catalog/Online EXCLUSIVE
C. NEW Craftsman Gold Titanium Finish, Thin-Profile Ratchet in Chopper Engraved Walnut Case. Craftsman's best ratchet with gold titanium finish in a 2008-dated and serialized walnut display case with the Craftsman Chopper engraved on the box lid. Thin-profile ratchet provides easy access in tight applications. Made in USA. Wt. 1.63 lbs.

009-8305479.99
P Personalized 009-8305599.99

Catalog/Online EXCLUSIVE
D. NEW Craftsman 8-piece Gold Titanium Finish Socket Wrench Set with Walnut Case. Part of the Craftsman box collection. Gold titanium finish over our standard chrome plating results in a durable strong finish. This 3/8-inch drive set features a full polish ratchet and seven sockets. Sizes include 1/2, 9/16, 5/8, 11/16, 3/4, 13/16, 7/8-inch. Comes in a serialized walnut display box. Made in USA. Wt. 3.31 lbs.

009-83052119.99
P Personalized 009-83053139.99

Catalog/Online EXCLUSIVE
E. NEW Craftsman Gold Titanium Finish Cap Wrench Bottle Cap Opener. The handiest tool around when you're not working. Crafted with the sleek, durable gold titanium finish, this solid metal opener features a patented fulcrum design to open bottles by either pulling forward or backward. Made in USA. Wt. 0.64 lb.

009-8305624.99
P Personalized 009-8306734.99

Catalog/Online EXCLUSIVE
F. NEW Craftsman 4-piece Gold Titanium Finish Cross-Force Wrench Set with Walnut Case. This set features innovation and durable gold titanium finish with a Craftsman walnut case. Sizes include 5/16, 3/8, 7/16, 1/2-inch. Made in USA. Wt. 1.85 lbs.

009-82869129.99
P Personalized 009-82899149.99

*Warranted, see page 94a.
◆ See "N" suffix note on page 94a.

CRAFTSMAN®

BUILD-A-SET

A CUSTOMIZED TOOL SET PROGRAM.

11 complete modules of specific tools allow you to choose the best set for the work you do. The molded compartments provide easy organization and the modular design fits in most Craftsman permanent and portable tool storage units. Each module is unique, giving you the ultimate in tool selection.



1 CHOOSE YOUR TOOLS

Choose from a variety of unique modules to build your own set. Stay organized with molded compartments.



2 EASY ORGANIZATION

For easy organization, slide the Tool Modules into your permanent Craftsman tool chests.

Catalog/Online EXCLUSIVE

A. NEW 43-pc. Bit Socket Module.

- 5 1/4-in. hex bit sockets (3/16 thru 3/8 in.)
- 2 1/4-in. screwdriver bit sockets (7/32 and 1/4 in.)
- 2 1/4-in. Phillips bit sockets (P-1 and P-2)
- 3 1/4-in. Torx® bit sockets (T-15, T-20, T-25)
- 6 3/8-in. inch hex bit sockets (5/32 thru 3/8 in.)
- 3 3/8-in. metric hex bit sockets (4 thru 8, 10 mm)
- 6 3/8-in. screwdriver bit sockets (7/32, 9/32 and 3/8 in.)
- 4 3/8-in. Phillips bit sockets (#1 thru #4)
- 6 3/8-in. Torx® bit sockets (T-27, T-30, T-40, T-45, T-47, T-50)

- 2 1/2-in. inch hex bit sockets (9/16 thru 5/8 in.)
 - 2 1/2-in. metric hex bit sockets (14 and 17 mm)
 - 2 1/2-in. Torx® bit sockets (T-55, T-60)
- Separate prices total \$285.67. Wt. 5.1 lbs.

009-87632 129.99

Catalog/Online EXCLUSIVE

B. NEW 38-pc. 3/8-inch Drive Impact Module.

- 9 6-pt. inch impact sockets (1/4 thru 3/4 in.)
- 9 6-pt. metric impact sockets (10 thru 18 mm)
- 8 6-pt. inch deep impact sockets (5/16 thru 3/4 in.)
- 8 6-pt. metric deep impact sockets (12 thru 19 mm)
- 1 Impact universal joint
- 2 Impact extension bars (3 and 6 in.)
- 1 3/8 inch drive air-driven ratchet

Separate prices total \$319.92. Wt. 9 lbs.

009-87634 169.99

Catalog/Online EXCLUSIVE

C. NEW 14-pc. Master Drive Tool Module.

- 1 1/4 inch extension bar (14 in.)
- 1 1/4 inch universal joint
- 1 1/4 inch adapter (3/8 in.)
- 1 1/4 inch spinner handle (6 in.)
- 1 1/4 inch flex T handle (6 in.)
- 1 1/4 inch flex extension (1/4 in.)
- 1 3/8 inch extension bar (10 in.)
- 1 3/8 inch universal joint
- 2 3/8 inch adapters (1/4 and 1/2 in.)
- 1 3/8 inch flex T handle (10 in.)
- 1 1/2 inch extension bar (10 in.)
- 1 1/2 inch universal joint
- 1 1/2 inch adapter (3/8 in.)

Separate prices total \$115.36. Wt. 4.19 lbs.

009-87633 79.99



ALL NEW

D. NEW 48-pc. 1/4-inch Drive Socket Module.

- 11 6-pt. inch (5/32 thru 9/16 in.)
- 12 6-pt. metric (4, 5, 5.5, 6 thru 14 mm)
- 10 6-pt. inch deep (3/16 thru 9/16 in.)
- 11 6-pt. metric deep (4 thru 14 mm)
- 1 Thin-profile ratchet
- 3 Extension bars (1 1/2, 3, 6 in.)

Separate prices total \$140.53. Wt. 3.63 lbs.

009-34270 69.99

NOTE Tray sizes vary slightly, depending upon set contents. Exact dimensions as follows:
A, C, D, E, G, K: 12 7/8 x 10 1/2 x 1 1/2
B, J, L: 13 7/8 x 10 1/2 x 1 7/9
F: 13 7/8 x 10 1/2 x 1 3/4
H: 10 7/8 x 13 7/8 x 2

>> Check online for SALE PRICING!

*Warranted, see page 94a.



NEW Durable 4-Drawer Portable Storage Case.

This unique tool chest has four drawers. Drawers are specially designed to fit module tray sizes 13 7/8 x 10 7/8 in. Pick and choose your set to take anywhere. Wt. 12.1 lbs.
009-10152 39.99



These modular sets let you customize and organize your own tool set.

3 QUICK TRANSPORTATION

Easily bring your tools to the job site in our portable storage unit.

ED'S PICK

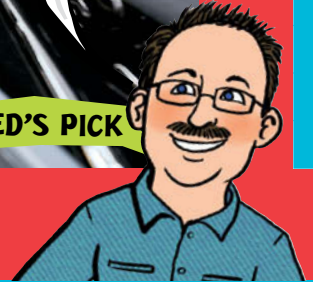

E. NEW 49-pc. 3/8-inch Drive Socket Module.

- 12 6-pt. inch (1/4 thru 1 in.)
- 15 6-pt. metric (6 thru 20 mm)
- 9 6-pt. inch deep (3/8 thru 3/4, 7/8, 15/16 in.)
- 9 6-pt. metric deep (9 thru 15, 17, 18 mm)
- 1 Inch thin-profile ratchet
- 3 Extension bars (1 1/2, 3, 6 in.)

Separate prices total \$207.01. Wt. 8.38 lbs.
009-34271 89.99



F. NEW 43-pc. 1/2-inch Drive Socket Module.

- 12 12-pt. inch (7/16 thru 1 1/8 in.)
- 12 12-pt. metric (11 thru 15, 17 thru 19, 21, 24, 27, 30 mm)
- 9 12-pt. inch deep (1/2 thru 1 in.)
- 7 12-pt. metric deep (13 thru 15, 17 thru 19, 21 mm)
- 1 Thin-profile ratchet
- 2 Extension bars (3 and 6 in.)

Separate prices total \$277.57. Wt. 13.19 lbs.
009-34272 129.99



G. NEW 18-pc. Full Polish Combo Wrench Module.

- 9 12-pt. inch (1/4 thru 3/4 in.)
- 9 12-pt. metric (10 thru 18 mm)

Separate prices total \$191.62. Wt. 6.06 lbs.
009-34273 99.99



H. NEW 10-pc. Large Full Polish Combo Wrench Module.

- 5 12-pt. inch (13/16 thru 1 1/16 in.)
- 5 12-pt. metric (19, 21 thru 24 mm)

Separate prices total \$197.40. Wt. 9.13 lbs.
009-34274 129.99



J. NEW 52-pc. 1/2-inch Drive Impact Socket Module.

- 1 Impact universal joint
- 3 Impact extension bars (3, 6, 10 in.)
- 12 6-pt. inch impact (3/8 thru 1 1/16 in.)
- 12 6-pt. metric impact (12 thru 19, 21, 22, 24, 27 mm)
- 12 6-pt. inch deep impact (3/8 thru 1 1/16 in.)
- 12 6-pt. metric deep impact (12 thru 19, 21, 22, 24, 27 mm)

Separate prices total \$433.94. Wt. 28.5 lbs.
009-15820 199.99



K



ALL NEW

K. NEW 68-pc. General Purpose Tool Set Module.

- 7 Inch nut drivers (3/16 thru 1/2 in.)
- 7 Metric nut drivers (5 thru 11 mm)
- 6 Torx® screwdrivers (T-10 thru T-30)
- 2 Phillips screwdrivers (2 x 8 and 3 x 6)
- 2 Slotted screwdrivers (3/16 x 6 and 1/4 x 6)

20-pc. Hex key set inch

20-pc. Hex key set metric

- 1 6 3/4 inch slip joint pliers
- 1 5-in. diagonal cutting pliers
- 1 12 oz. plastic tip hammer
- 1 8-in. adjustable wrench

Separate prices total \$219.00. Wt. 9.88 lbs.

009-34275 149.99

L. NEW 10-pc. Brake Set Module.

- 3-pc. Brake caliper socket set
- 1 Brake spring
- 1 Brake pad spreader
- 1 Brake cylinder hone
- 1 Brake adjusting tool
- 1 Brake spring pliers
- 1 Brake tool shoe spring
- 1 Lock ring pliers

Separate prices total \$83.92. Wt. 5.5 lbs.

009-34276 69.99



FIND OUT MORE ABOUT OUR BUILD-A-SET PROGRAM AND CHOOSE THE TOOLS THAT WORK FOR YOU—AT SEARS.COM/SHOPTOOLS

ALL FOR \$999⁹⁷

CRAFTSMAN[®]

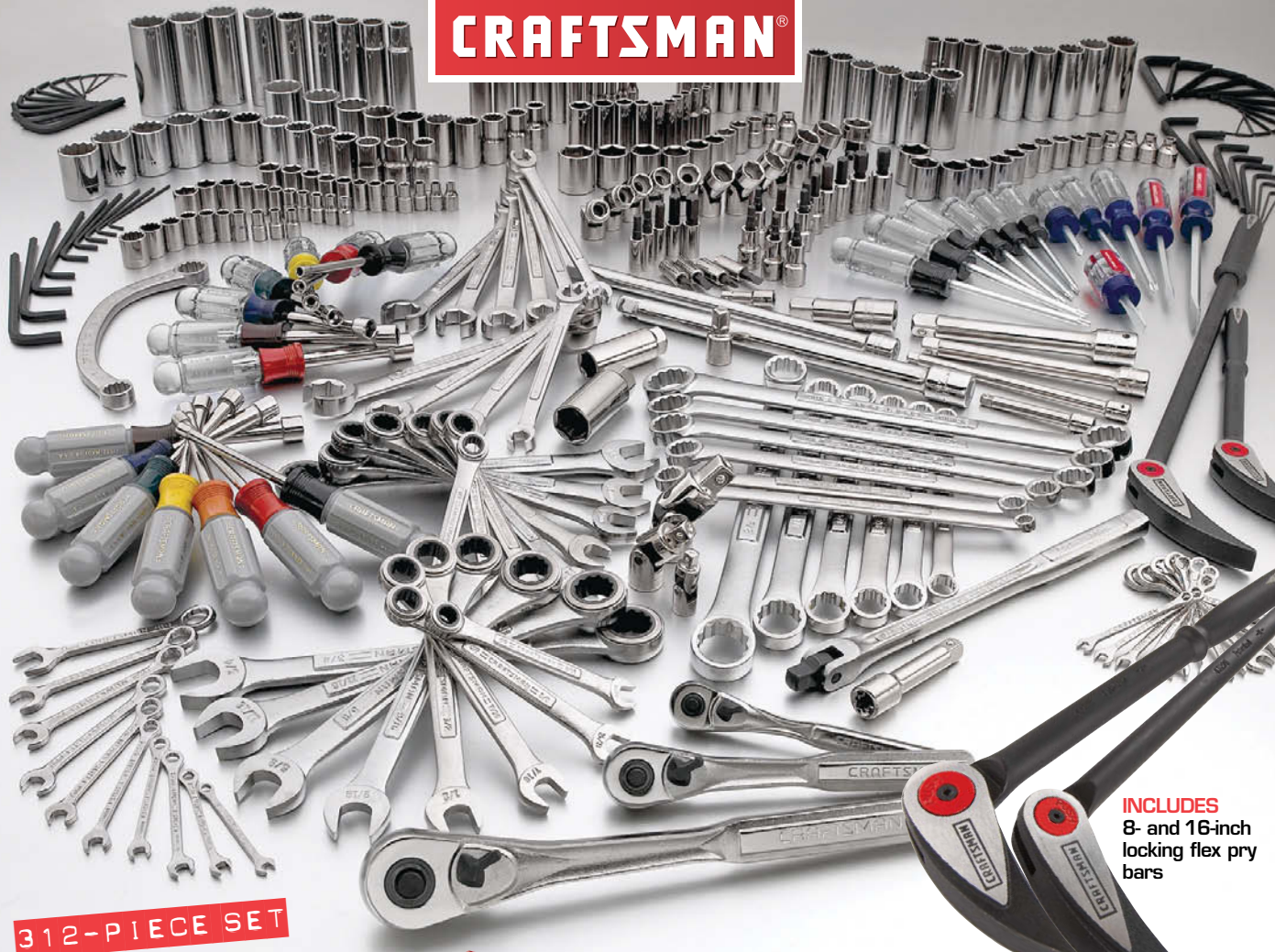

312-PIECE SET

INCLUDES
8- and 16-inch
locking flex pry
bars

A. NEW OVER \$1,580 VALUE

GREAT SAVINGS ON THIS COMBO!

MORE TO EXPLORE
at sears.com!

Catalog/Online EXCLUSIVE
A and B. NEW-SAVE *150 Craftsman 312-piece Mechanic's Tool Set with 10-Drawer Red Ball-Bearing Storage Combo. Separate prices total \$1,149.97. Wt. 245.38 lbs.
009-94676N ♦ **999.97**

Catalog/Online EXCLUSIVE
A. NEW Craftsman 312-piece Mechanic's Tool Set with 8- and 16-inch Locking Flex Pry Bars. All the essential tools to outfit your shop and then some! Set includes 168 sockets, 10 extension bars, 16 ratcheting wrenches, 12 box end wrenches, 10 flare nut wrenches, 14 nut drivers, 12 screwdrivers, and more. Plus **INCLUDES** 8- and 16-inch locking flex pry bars with 13 locking positions. Separate prices total \$1,581.14. Made in USA. Guaranteed Forever![®] Wt. 48.38 lbs.
009-87622 **699.99**

B. Craftsman 10-Drawer Red Ball-Bearing Storage Combo. Provides 14,549 cu. in. of storage. See 009-87738 and 009-87740 on page 16 for more details. Wt. 197 lbs.
009-94687N ♦ **449.98**



A. 312-Piece

1/4-in. sq. drive sockets

- 11 6-pt. inch (5/32 thru 9/16 in.)
- 12 6-pt. metric (4, 5, 5.5, 6 thru 14 mm)
- 10 12-pt. inch (3/16 thru 9/16 in.)
- 10 6-pt. inch deep (3/16 - 9/16 in.)
- 11 6-pt. metric deep (4 thru 14 mm)
- 5 Inch hex bits (3/16 thru 3/8 in.)
- 4 Screwdriver bits: 2 slotted (5-6, 6-8), 2 Phillips (#1, #2)
- 3 Extension bars (1 1/2, 3, 6 in.)
- 1 ea. Quick-release ratchet, universal joint

1/2-in. sq. drive sockets

- 10 12-pt. inch (7/16 thru 1 in.)
- 13 12-pt. metric (12 thru 24 mm)
- 9 12-pt. inch deep (1/2 thru 1 in.)
- 3 Extension bars (3, 6 and 10 in.)
- 1 ea. Quick-release ratchet, universal joint

specialty tools

- 12 Screwdrivers: 3 slotted (3/16 x 4, 1/4 x 6, 1/4 x 1 1/2 stubby); 3 Phillips (#1 x 3, #2 x 4, #2 x 1/2 stubby); 6 Torx[®] (T-10, T-15, T-20, T-25, T-27, T-30)
- 40-pc. Hex key set: 20 inch and 20 metric
- 14 Nut drivers: 7 inch (3/16 thru 1/2 in.); 7 metric (5 thru 11 mm)
- 2 Locking flex pry bars (8 and 16 inch)

3/8-in. sq. drive sockets

- 11 6-pt. inch (1/4 thru 7/8 in.)
- 15 6-pt. metric (6 thru 20 mm)
- 9 12-pt. inch deep (3/8 thru 7/8 in.)
- 12 12-pt. metric deep (9 thru 19, 21 mm)
- 5 6-pt. inch flex (3/8 thru 5/8 in.)
- 7 6-pt. metric flex (12 thru 18 mm)
- 6 Inch hex bits (5/32 thru 3/8 in.)
- 6 Metric hex bits (4 thru 8 mm, 10 mm)
- 4 Extension bars (1 1/2, 3, 6 and 10 in.)
- 2 6-pt. spark plug sockets (5/8 and 13/16 in.)
- 1 ea. Quick-release ratchet, universal joint and 10-inch flex T-handle

wrenches

- 16 Ratcheting 8 inch (5/16 thru 3/4 in.), 8 metric (8, 10 thru 15, 18 mm)
- 12 Box end: 6 inch (3/8 x 7/16, 7/16 x 1/2, 1/2 x 9/16, 9/16 x 5/8, 5/8 x 3/4, 3/4 x 7/8 in.); 6 metric (7 x 9, 10 x 11, 12 x 14, 16 x 18, 17 x 19, 20 x 22 mm)
- 10 Flare nut: 4 inch (3/8 x 7/16, 1/2 x 9/16, 5/8 x 11/16, 3/4 x 7/8 in.); 6 metric (9 x 11, 10 x 12, 13 x 14, 15 x 17, 16 x 18, 19 x 21 mm)
- 1 Obstruction wrench (9/16 x 5/8 in.)
- 20-pc. Combination ignition wrench set: 10 inch and 10 metric

[®]Warranted, see page 94a.
♦ See "N" suffix note on page 94a.

ALL FOR \$1,149⁹⁷

MECHANIC'S TOOLS



385-PIECE SET

C. NEW OVER \$2,110 VALUE

C. 385-Piece

1/4-in. sq. drive sockets

- 11 6-pt. inch (5/32 thru 9/16 in.)
- 12 6-pt. metric (4, 5, 5.5, 6 thru 14 mm)
- 10 12-pt. inch (3/16 thru 9/16 in.)
- 10 6-pt. inch deep (3/16 - 9/16 in.)
- 11 6-pt. metric deep (4 thru 14 mm)
- 10 12-pt. inch deep (3/16 - 9/16 in.)
- 5 Inch hex bits (3/16 thru 3/8 in.)
- 4 Screwdriver bits: 2 (7/32 in. - 1/4 in.), 2 Phillips (#1, #2)
- 3 Torx® bits (T-15, T-20, T-25)
- 3 Extension bars (1 1/2, 3, 6 in.)
- 1 ea. Thin-profile ratchet, adapter, spinner handle, universal joint

1/2-in. sq. drive sockets

- 16 12-pt. inch (3/8 thru 1 1/8 in.)
- 16 12-pt. metric (9 thru 24 mm)
- 9 12-pt. inch deep (1/2 thru 1 in.)
- 9 12-pt. metric deep (13 thru 21 mm)
- 2 Extension bars (3 and 6 in.)
- 2 Spark plug sockets (5/8, 13/16)
- 1 ea. Thin-profile ratchet, universal joint, Flex T-handle, Adapter

3/8-in. sq. drive sockets

- 13 6-pt. inch (1/4 thru 1 in.)
- 17 6-pt. metric (6 thru 22 mm)
- 5 8-pt. inch (1/4 thru 1/2 in.)
- 13 12-pt. inch (1/4 thru 1 in.)
- 15 12-pt. metric (6 thru 19, 21 mm)
- 11 6-pt. inch deep (3/8 - 1 in.)
- 11 6-pt. metric deep (9 thru 19 mm)
- 6 Inch hex bits (5/32 thru 3/8 in.)
- 6 Metric hex bits (4 thru 8, 10 mm)
- 7 Screwdriver bits: 3 slotted (7/32, 9/32, 3/8 in.), 4 Phillips (#1, #2, #3, #4)
- 4 Torx® bits (T-30, T-40, T-45, T-50)
- 3 Extension bars (1 1/2, 3 and 6 in.)
- 2 Adapters (1/4, 1/2 in.)
- 4 Spark plug sockets (5/8, 13/16, 3/4 and 18 mm)
- 1 ea. Thin-profile ratchet, universal joint

wrenches

- 26 Combination: 12 inch (5/16 thru 5/8, 3/4 in.), 14 metric (6 thru 19 mm)
- 14 Locking Flex Ratcheting wrench: 7 inch (5/16 thru 5/8, 3/4 in.) 7 metric (8, 10, 12, 13, 15, 17, 19 mm.)
- 10 Flare nut: 4 inch (3/8 x 7/16, 1/2 x 9/16, 5/8 x 11/16, 3/4 x 7/8 in.); 6 metric (9 x 11, 10 x 12, 13 x 14, 15 x 17, 16 x 18, 19 x 21 mm)
- 14 Wrench Socket: 7 inch (3/8 thru 3/4 in.); 7 metric (8, 10, 12 thru 15, 17 mm)
- 20-pc. Combination ignition wrench set: 10 inch and 10 metric

specialty tools

- 12 Nut drivers: 6 inch (3/16 thru 1/2 in.); 6 metric (5 thru 10 mm)
- 14 T-Through Handle Hex keys: 7 inch (3/32 thru 1/4 in.); 7 metric (2.5 thru 6, 8, 10 mm)
- 14 Screwdrivers: 4 Phillips (#0 x 2 1/2, #1 x 3, #2 x 4, stubby); 4 slotted (1/8 x 2, 3/16 x 4, 1/4 x 4, stubby); 6 Torx® (T-10, T-15, T-20, T-25, T-27, T-30)
- 1 Slip-joint pliers (6 3/4 in.)

385 Pieces

- 240 sockets
- 70 wrenches
- 20 drive tools
- 55 specialty tools

SAVE \$150 C and D. Craftsman 385-piece Mechanic's Tool Set with 10-Drawer Midnight Blue Ball-Bearing Storage Combo. Separate prices total \$1,299.97. Wt. 244.2 lbs. 009-93310N◆.....1,149.97

Catalog/Online EXCLUSIVE C. NEW Craftsman 385-piece Mechanic's Tool Set. Featuring an assortment of wrench styles including combination, flex ratcheting, flare nut and ignition, full polish thin profile ratchets and more. See chart for full list of tools. Separate prices total \$2,119.55. Made in USA. Guaranteed Forever!® Wt. 76.2 lbs. 009-83076949.99



D. Craftsman 10-Drawer Ball-Bearing Combo in Midnight Blue Provides 11,971 cu. in. of storage. See 009-61806 and 009-61810 on page 16 for details. Wt. 168 lbs. 009-61798N◆349.98



214-PIECE SET

A. OVER \$850 VALUE INCLUDES IMPACT GUN AND SOCKETS

A. 214-piece

- 1/4-in. sq. drive**
- 11 6-pt. inch (5/32 thru 9/16 in.)
 - 11 6-pt. metric (4 thru 14 mm)
 - 9 6-pt. inch deep (3/16 thru 1/2 in.)
 - 10 6-pt. metric deep (4 thru 13 mm)
 - 1 Quick-release ratchet
 - 1 3-inch extension bar

- 3/8-in. sq. drive**
- 11 6-pt. inch (1/4 thru 7/8 in.)
 - 11 6-pt. metric (8 thru 18 mm)
 - 7 12-pt. inch (1/2 thru 7/8 in.)
 - 8 12-pt. metric (12 thru 19 mm)
 - 5 6-pt. inch deep (7/16 thru 11/16 in.)
 - 5 6-pt. metric deep (10, 12 thru 15 mm)
 - 9 6-pt. inch impact (1/4 thru 3/4 in.)
 - 10 6-pt. metric impact (10 thru 19 mm)
 - 1 Impact wrench
 - 1 Quick-release ratchet
 - 2 Extension bars (3 and 6 inch)
 - 1 5/8-inch spark plug socket

- 1/2-in. sq. drive sockets**
- 7 12-pt. inch (1/2 thru 7/8 in.)
 - 7 12-pt. metric (13 thru 19 mm)
 - 4 6-pt. inch deep (1/2 thru 11/16 in.)
 - 4 6-pt. metric deep (12 thru 15 mm)
 - 1 Quick-release ratchet

- wrenches & specialty tools**
- 7 Inch combination wrenches (1/4 thru 5/8 in.)
 - 7 Metric combination wrenches (9 thru 15 mm)
 - 1 Magnetic handle
 - 10-pc. Screwdriver bit set
 - 12-pc. Nut driver bit set (inch/metric)
 - 20-pc. Inch hex key set
 - 20-pc. Metric hex key set

A and B. NEW-SAVE \$50 Craftsman 214-piece Dual-Mark Mechanic's Tool Set with 3-Drawer Black Ball-Bearing GRIPLATCH® Utility Cart. Provides 15,392 cu. in. of storage. Separate prices total \$649.98. Wt. 133.5 lbs. **009-94674.....599.98**

Catalog/Online EXCLUSIVE A. Craftsman 214-piece Dual-Mark Mechanic's Tool Set with 3/8-inch Drive Impact Sockets and Air Impact Wrench. A powerful combination of 130 of our most popular Dual-Mark sockets, along with rugged impact sockets and a Craftsman 3/8-inch reversible impact wrench with silencing technology. Also includes 3 extension bars, 14 combination wrenches and more. Separate prices total \$856.94. Guaranteed Forever!® Wt. 24.5 lbs. **009-87624.....299.99**

B. Craftsman 3-Drawer Black Ball-Bearing GRIPLATCH® Utility Cart. Provides 15,392 cu. in. of storage. 3-inch deep bottom shelf and three drawers (one full width, two split). 5 x 2-inch casters (two fixed, two swivel) provide a 750 lb. load rating. Measures 34W x 20 1/2D x 37 1/4H in. (with side handle). Wt. 109 lbs. **009-59740.....349.99**



CRAFTSMAN®

C. NEW OVER \$1,510 VALUE INCLUDES 48 COMBINATION WRENCHES

BUY ONLINE PICK-UP IN STORE!
on eligible items

Catalog/Online EXCLUSIVE

370-piece mechanic's tool set

- 247 sockets
- 48 wrenches
- 18 drive tools
- 57 specialty tools

C. NEW Craftsman 370-piece Mechanic's Tool Set. This diverse set is ideal for tackling big, small and specialty projects. Three drive sizes include 81 deep sockets and 11 extension bars for optimum access. See chart for full list of tools. Separate prices total \$1,516.96. Made in USA. Guaranteed Forever!® Wt 51.5 lbs. **009-83081.....499.99**

C. 370-piece

- 1/4-in. sq. drive sockets**
- 11 6-pt. inch (5/32 thru 9/16 in.)
 - 12 6-pt. metric (4, 5, 5.5, 6 thru 14 mm)
 - 10 12-pt. inch (3/16 thru 9/16 in.)
 - 10 6-pt. inch deep (3/16 - 9/16 in.)
 - 11 6-pt. metric deep (4 thru 14 mm)
 - 4 Screwdriver bits
 - 2 Slotted (7/32, 1/4 in.)
 - 2 Phillips (#1, #2)
 - 3 Torx® bits T-15, T-20, T-25)
 - 4 Extension bars (1 1/2, 3, 6, 14 in.)
 - 1 ea. Quick-release ratchet, universal joint

- 1/2-in. sq. drive sockets**
- 14 6-pt. inch (3/8 thru 1 1/4 in.)
 - 10 6-pt. metric (9 thru 15, 17, 19, 22 mm)
 - 14 12-pt. inch (3/8 thru 1 1/8 in.)
 - 14 12-pt. metric (9 thru 19, 21, 22, 24 mm)
 - 11 12-pt. inch deep (1/2 thru 1 1/8 in.)
 - 9 12-pt. metric deep (13 thru 19, 21, 22 mm)
 - 3 Extension bars (2, 3, 6 in.)
 - 1 ea. Quick-release ratchet

- 3/8-in. sq. drive sockets**
- 11 6-pt. inch (1/4 thru 7/8 in.)
 - 16 6-pt. metric (6 thru 21 mm)
 - 5 8-pt. inch (1/4 thru 1/2 in.)
 - 10 12-pt. inch (5/16 thru 7/8 in.)
 - 12 12-pt. metric deep (9 thru 19, 21 mm)
 - 9 6-pt. inch deep (3/8 thru 7/8 in.)
 - 11 6-pt. metric deep (9 thru 19 mm)
 - 9 12-pt. deep inch (3/8 thru 7/8 in.)
 - 11 12-pt. metric deep (9 thru 19 mm)
 - 3 Hex bits inch (5/32 thru 3/8)
 - 6 Hex bits metric (4 thru 8, 10 mm)
 - 6 Torx® bits T-27, T-30, T-40, T-45, T-47, T-50)
 - 4 Extension bars (1 1/2, 3, 6, 10 in.)
 - 2 Adapters (1/4 and 1/2 in.)
 - 2 Spark plug sockets (5/8 and 13/16 in.)
 - 1 ea. Quick-release ratchet, universal joint

- wrenches & specialty tools**
- 28 Combination: 14. inch (1/4 thru 1 in.); 14 metric (6 thru 19 mm)
 - 20 pc. Combination ignition set: 10 inch; 10 metric
 - 10 Nut drivers: 5 inch (1/4, 5/16, 3/8, 7/16, 1/2 in.); 5 metric (6 thru 8, 10, 11 mm)
 - 40 pc. Hex key set: 20 inch; 20 metric
 - 6 Screwdrivers: 3 slotted (1/8 x 4, 3/16 x 4, 1/4 x 4 in.); 3 Phillips (#0 x 2 1/2, #4 x 3, #2 x 4 in.)
 - 1 Slip-joint pliers, 6 3/4 in.

Catalog/Online EXCLUSIVE

D. NEW Craftsman 306-piece Dual-Mark Mechanic's Tool Set with T-Handle Nut Drivers. This comprehensive set features the convenience of easy-to-read Dual Mark sockets and the durability of stamping in 1/4, 3/8 and 1/2-inch drive sizes. Craftsman innovative T-handle nut drivers provide additional leverage for greater torque strength. Set includes 212 Dual-Mark sockets, 7 extension bars, 24 combination wrenches, 4 screwdrivers, 7 Torx® bit sockets and more plus 8-piece T-handle nut driver set. Separate prices total \$1,404.32. Made in USA. Guaranteed Forever!® Wt. 49.88 lbs.

009-87623399.99

Catalog/Online EXCLUSIVE

239-piece mechanic's tool set

Great starter set has 146 sockets including 35 deep sizes

- 9 nut drivers
- 8 drive tools
- 24 wrenches
- 52 specialty tools

E. Craftsman 239-piece Dual-Mark[†] Mechanic's Tool Set. Permanent markings resist chipping, fading, or corroding. Features 1/4, 3/8 and 1/2-inch drive sockets in inch and metric sizes. Includes tools in chart. Separate prices total \$962.38. Guaranteed Forever!® Wt. 28 lbs.

009-34239249.99

Catalog/Online EXCLUSIVE

Also Available

Craftsman 239-piece Non-Laser Etched Mechanic's Tool Set. Separate prices total \$838.68. Wt. 28 lbs.

009-36239199.99

SAVE \$10 on Chest "F" when you buy Tool Set "E."

F. Craftsman 3-Drawer Portable Tool Chest in Yellow. 1,588 cu. in. of storage.

Heavy-duty steel construction with full-extension drawers. Padlock eye. Measures 20 1/2W x 8 1/2D x 12H in. Wt. 19.4 lbs.

009-82595 Yellow49.99

When you buy with "E"39.99

[†]The size is laser marked for easy reading.

306-PIECE — MECHANIC'S TOOL SET

D.	NEW	OVER \$1,400 VALUE	INCLUDES T-HANDLE DRIVER SET
-----------	------------	---------------------------	-------------------------------------



D. 306-piece			
1/4-in. sq. drive sockets	3/8-in. sq. drive sockets	1/2-in. sq. drive sockets	wrenches
11 6-pt. inch (5/32 thru 9/16 in.)	13 6-pt. inch (1/4 thru 1 in.)	11 6-pt. inch (3/8 thru 1 in.)	24 Combination wrenches: 12 inch (1/4 thru 7/8 in.); 12 metric (6 thru 17 mm)
12 6-pt. metric (4, 5, 5.5, 6 thru 14 mm)	17 6-pt. metric (6 thru 22 mm)	14 6-pt. metric (9 thru 22 mm)	
	5 8-pt. inch (1/4 thru 1/2 in.)	6 8-pt. inch (7/16 thru 3/4 in.)	specialty tools
10 12-pt. inch (3/16 thru 9/16 in.)	11 12-pt. inch (1/4 thru 7/8 in.)	13 12-pt. inch (7/16 thru 1 1/8 in.)	4 Screwdrivers: 2 slotted (1/8 x 4, 3/16 x 4); 2 Phillips (#1 x 3, #2 x 4)
10 6-pt. inch deep (3/16 thru 9/16 in.)	11 12-pt. metric (9 thru 19 mm)	16 12-pt. metric (9 thru 24 mm)	40-pc. Hex key set: 20 inch and 20 metric
11 6-pt. metric deep (4 thru 14 mm)	11 6-pt. inch deep (3/8 thru 1 in.)	8 6-pt. inch deep (1/2 thru 15/16 in.)	4 T-handle Nut Drivers inch (1/4 thru 7/16 in.)
3 Torx® bits (T15, T20, T25)	11 6-pt. metric deep (9 thru 19 mm)	9 6-pt. metric deep (12 thru 19, 21)	1 Quick-release ratchet
1 Quick-release ratchet	4 Torx® bits (T-30, T-40, T-45, T-50)	1 Quick-release ratchet	2 Extension bars (3, 6 in.)
1 6-inch spinner handle	1 Quick-release long ratchet		
2 Extension bars (1 1/2, 3 inch)	3 Extension bars (1 1/2, 3, 6 in.)		
	2 Spark plug sockets (5/8, 13/16 in.)		

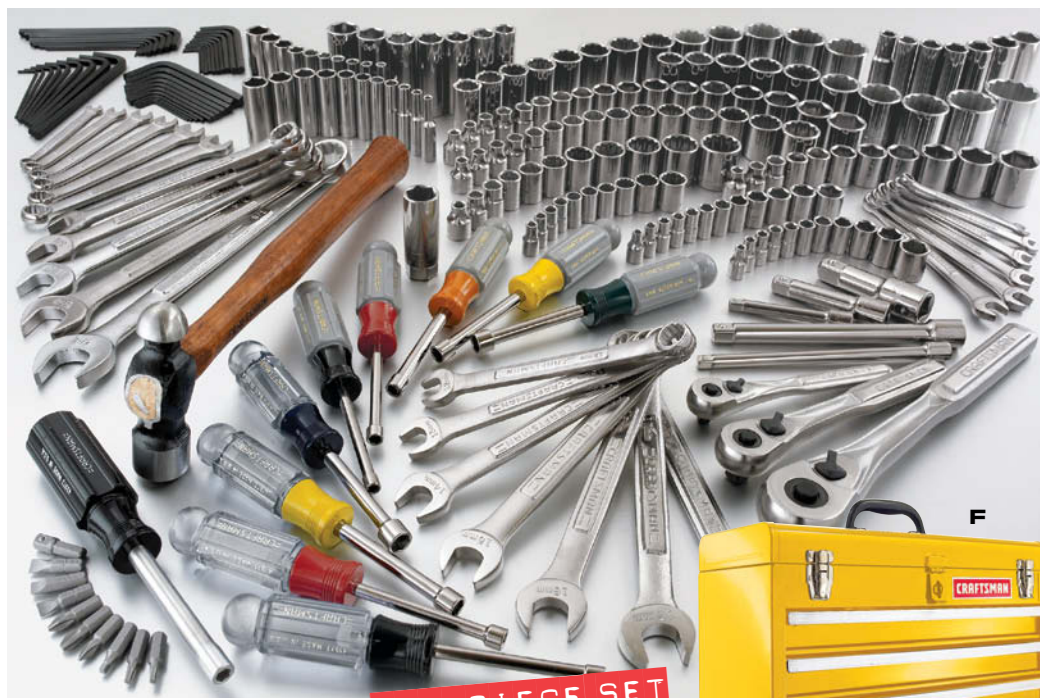

E.	OVER \$830 VALUE
-----------	-------------------------

E. 239-piece	
1/4-in. sq. drive sockets	3/8-in. sq. drive sockets
11 6-pt. inch (5/32 thru 9/16 in.)	11 6-pt. inch (1/4 thru 7/8 in.)
12 6-pt. metric (4, 5, 5.5, 6 thru 14 mm)	17 6-pt. metric (6 thru 22 mm)
10 6-pt. inch deep (3/16 thru 9/16 in.)	11 12-pt. inch (1/4 thru 7/8 in.)
11 6-pt. metric deep (4 thru 14 mm)	15 12-pt. metric (6 thru 19, 21 mm)
10 12-pt. inch (3/16 thru 9/16 in.)	7 6-pt. inch deep (3/8 thru 3/4 in.)
2 Extension bars (3 and 6 in.)	7 6-pt. metric deep (13 thru 19 mm)
1 Quick-release ratchet	2 Extension bars (3 and 6 in.)
	1 ea. Quick-release ratchet, 5/8-inch spark plug socket
1/2-in. sq. drive sockets	wrenches & specialty tools
10 12-pt. inch (5/8 thru 1 1/8, 1 1/4 in.)	24 Combination wrenches: 11 inch (1/4 thru 7/8 in.); 13 metric (6 thru 18 mm)
13 12-pt. metric (15 thru 27 mm)	9 Nut drivers: 4 inch (3/16 thru 5/16, 3/8 in.); 5 metric (5 thru 9 mm)
1 ea. Quick-release ratchet, 3-inch extension bar	1 Magnetic handle
	40-pc. Hex key set (20 inch and 20 metric)
	10-pc. Screwdriver bit set
	1 12 oz. ball peen hammer

*Warranted, see page 94a.
◆ See "N" suffix note on page 94a.

413-PIECE — PROFESSIONAL SET

Save \$30 when you buy "A" and "B"



413-PIECE SET

A. INCLUDES 55 WRENCHES

SAVE \$30 when you buy the complete combo "A" and "B" Craftsman 413-piece Professional Mechanic's Tool Set, 11-Drawer Combo in Yellow. Provides 14,491 cu. in. of storage. Separate prices total \$1,299.97. Wt. 283.5 lbs. **009-93312N** ♦ **Combo 1,269.97**

413-piece mechanic's tool set
 • 271 sockets, including 62 deep for access
 • 55 combination wrenches • 20 drive tools
 • 67 specialty tools

Catalog/Online EXCLUSIVE

A. Craftsman 413-piece Professional Mechanic's Tool Set. This extensive set includes 271 sockets, including a complete assortment of hex, Torx® and screwdriver bit sockets. Also comes with 55 combination wrenches and 14 nut drivers. Includes tools listed in chart below. Also available Personalized. Have your name, slogan or business name of 2 rows of 12 characters laser-etched on all sockets, ratchets, drive tools and wrenches. See page 43 for more details. Separate prices total \$1,907.62. Made in USA. Guaranteed Forever!® Wt. 75 lbs.

009-33413 **599.99**

P Personalized 009-36413 **699.99**

B. Craftsman 11-Drawer Ball-Bearing GRIPLATCH® Combo in Traffic Yellow. 14,491 cu. in. of storage. See 009-82527 and 009-82528 on page 14 for more details. Wt. 208.5 lbs.

009-93264N ♦ **699.98**



CRAFTSMAN

A. 413-piece

1/4-in. sq. drive sockets

- 11 6-pt. inch (5/32 thru 9/16 in.)
- 12 6-pt. metric (4 thru 14 mm)
- 10 12-pt. inch (3/16 thru 9/16 in.)
- 10 6-pt. inch deep (3/16 thru 9/16 in.)
- 11 6-pt. metric deep (4 thru 14 mm)
- 5 Inch hex bits (3/16 thru 3/8 in.)
- 3 Torx® bits (T-15, T-20, T-25)
- 3 Extension bars (3, 6, 14 in.)
- 1 Quick-release ratchet
- 1 Universal joint
- 1 6-inch spinner handle
- 1 6-inch flex T-handle
- 3 External Torx® (E6, E7, E8)

1/2-in. sq. drive sockets

- 11 6-pt. inch (3/8 thru 1 in.)
- 14 6-pt. metric (9 thru 22 mm)
- 6 8-pt. inch (7/16 thru 3/4 in.)
- 15 12-pt. inch (3/8 thru 1 1/4 in.)
- 21 12-pt. metric (9 thru 27, 30, 32 mm)
- 9 12-pt. inch deep (1/2 thru 1 in.)
- 10 12-pt. metric deep (13 thru 22 mm)
- 2 Inch hex bits (9/16, 5/8 in.)
- 2 Metric hex bits (14, 17 mm)
- 2 Torx® bits (T-55, T-60)
- 1 Quick-release ratchet
- 3 Extension bars (3, 6, 10 in.)
- 1 15-inch flex T-handle

wrenches and specialty tools

- 35 Combination wrenches: 16 inch (1/4 thru 1 1/8 in.), 19 metric (6 thru 24 mm)
- 20 Combination ignition: 10 inch, 10 metric
- 7 Nut driver inch (3/16 thru 1/2 in.)
- 7 Nut driver metric (5 thru 11 mm)
- 1 Magnetic handle
- 10-pc. Screwdriver bit set
- 40-pc. Hex key set (20 inch, 20 metric)
- 1 Slip joint pliers (6 3/4 in.)
- 1 Long needle nose pliers (6 in.)

3/8-in. sq. drive sockets

- 13 6-pt. inch (1/4 thru 1 in.)
- 17 6-pt. metric (9 thru 22 mm)
- 5 8-pt. inch (1/4, 5/16, 3/8, 7/16, 1/2 in.)
- 11 12-pt. inch (1/4 thru 7/8 in.)
- 15 12-pt. metric (6 thru 19, 21 mm)
- 11 6-pt. inch deep (3/8 thru 1 in.)
- 11 6-pt. metric deep (9 thru 19 mm)

- 6 Inch hex bits (5/32 thru 3/8 in.)
- 6 Metric hex bits (4 thru 8, 10 mm.)
- 7 Screwdriver bits (7/32, 9/32, 3/8, #1, #2, #3, #4)
- 6 Torx® bits (T-27, T-30, T-40, T-45, T-47, T-50)
- 4 External Torx® (E10, E12, E14, E16)
- 1 Quick-release long ratchet

- 3 Extension bars (1 1/2, 3, 6 in.)
- 1 Universal joint
- 2 Adapters (1/4 inch and 1/2 in.)
- 1 10-inch flex T-handle
- 2 Spark plug sockets (5/8 and 13/16 in.)

C. 427-piece

1/4-in. sq. drive sockets

- 11 6-pt. inch (5/32 thru 9/16 in.)
- 12 6-pt. metric (4, 5, 5.5, 6 thru 14 mm)
- 10 12-pt. inch (3/16 thru 9/16 in.)
- 10 6-pt. inch deep (3/16 thru 9/16 in.)
- 11 6-pt. metric deep (4 thru 14 mm)
- 10 12-pt. inch deep (3/16 thru 9/16 in.)
- 5 Inch hex bits (3/16 thru 3/8 in.)
- 4 Screwdriver bits (7/32, 1/4, P-1, P-2)
- 3 Torx® bits (T-15, T-20, T-25)
- 3 Extension bars (1 1/2, 3, 6 in.)
- 1 Quick-release ratchet
- 1 4 1/2 in. socket extension
- 1 Universal joint
- 1 3/8 in. Adapter
- 1 6-inch spinner handle
- 1 6-inch flex T-handle

3/8-in. sq. drive sockets

- 13 6-pt. inch (1/4 thru 1 in.)
- 17 6-pt. metric (6 thru 22 mm)
- 5 8-pt. inch (1/4, 5/16, 3/8, 7/16, 1/2 in.)
- 10 12-pt. inch (5/16 thru 7/8 in.)
- 12 12-pt. metric (9 thru 19, 21 mm)
- 11 12-pt. inch deep (3/8 thru 1 in.)
- 12 12-pt. metric deep (9 thru 19, 21 mm)
- 7 Screwdriver bits (7/32, 9/32, 3/8, #1, #2, #3, #4)
- 4 Torx® bits, (T-30, T-40, T-45, T-50)
- 3 Extension bars (1 1/2, 3, 6 in.)
- 2 Spark plug sockets (5/8 and 13/16 in.)
- 2 Adapters (1/4 inch and 1/2 in.)
- 1 Quick-release long ratchet
- 1 Universal joint
- 1 10-inch flex T-handle

1/2-in. sq. drive sockets

- 9 6-pt. inch (3/8 thru 7/8 in.)
- 14 6-pt. metric (9 thru 22 mm)
- 13 12-pt. inch (3/8 thru 1 1/8 in.)
- 10 12-pt. metric (9 thru 18 mm)
- 9 12-pt. inch deep (1/2 thru 1 in.)
- 9 12-pt. metric deep (13 thru 21 mm)
- 2 Extension bars (3, 6 in.)
- 2 Spark plug sockets (5/8 and 13/16 in.)
- 1 Quick-release ratchet
- 1 Universal joint
- 1 3/8 in. adapter
- 1 15-inch flex T-handle

wrenches

- 30 Combination wrenches: 14 inch (1/4 thru 1 in.), 16 metric (6 thru 21 mm)
- 20 Combination ignition: 10 inch, 10 metric
- 16 Ratcheting combination wrenches: 8 inch (5/16 thru 3/4 in.), 8 metric (8, 10 thru 15, 18 mm)
- 12 Open end wrenches: 6 inch (1/4 x 5/16, 3/8 x 7/16, 1/2 x 9/16, 5/8 x 3/4, 11/16 x 13/16, 3/4 x 7/8); 6 metric (6 x 8, 7 x 9, 10 x 11, 12 x 14, 13 x 15, 16 x 18 mm)
- 10 Box end wrenches: 5 inch (1/4 x 5/16, 3/8 x 7/16, 7/16 x 1/2, 9/16 x 5/8, 5/8 x 3/4); 5 metric (10 x 11, 12 x 14, 13 x 15, 16 x 18, 17 x 19 mm)
- 8 Flare nut: 4 inch (3/8 x 7/16, 1/2 x 9/16, 5/8 x 11/16, 3/4 x 7/8 in.); 4 metric (9 x 11, 10 x 12, 13 x 14, 15 x 17 mm)
- 1 Obstruction wrench (9/16 x 5/8 in.)

specialty tools

- 16 Screwdrivers (8 Phillips, 8 slotted)
- 14 T-handle nut drivers: 7 inch (3/16, 1/4, 5/16, 11/32, 3/8, 7/16, 1/2 in.); 7 metric (5, 6, 7, 8, 9, 10, 11 mm)
- 40 Hex keys (20 inch, 20 metric)
- 2 Pliers (6-in. long nose; 6 3/4-in. slip joint)

E. 540-piece

1/4-in. sq. drive sockets

- 11 6-pt. inch (5/32 thru 9/16 in.)
- 12 6-pt. metric (4 thru 14 mm)
- 10 12-pt. inch (3/16 thru 9/16 in.)
- 10 6-pt. inch deep (3/16 thru 9/16 in.)
- 11 6-pt. metric deep (4 thru 14 mm)
- 10 12-pt. inch deep (3/16 thru 9/16 in.)
- 5 Inch hex bits (3/16 thru 3/8 in.)
- 4 Screwdriver bits (7/32, 1/4, P-1, P-2)
- 3 Torx® bits (T-15, T-20, T-25)
- 3 External Torx® (E6, E7, E8)
- 4 Extension bars (1 1/2, 3, 6, 14 in.)
- 1 Quick-release ratchet
- 1 Universal joint
- 1 Adapter (3/8 in.)
- 1 6-inch flex T-handle
- 1 6-inch spinner handle

1/2-in. sq. drive sockets

- 15 6-pt. inch (3/8 thru 1 1/4 in.)
- 14 6-pt. metric (9 thru 22 mm)
- 6 8-pt. inch (7/16 thru 3/4 in.)
- 15 12-pt. inch (3/8 thru 1 1/4 in.)
- 21 12-pt. metric (9 thru 29 mm)
- 6 6-pt. inch deep (11/16 thru 1 in.)
- 11 12-pt. inch deep (1/2 thru 1 1/8 in.)
- 12 12-pt. metric deep (13 thru 22, 24, 27 mm)
- 3 Extension bars (3, 6 and 10 in.)
- 2 Spark plug sockets (5/8 and 13/16 in.)
- 1 Quick-release ratchet
- 1 Universal joint
- 1 3/8-inch adapter
- 1 15-inch flex T-handle

3/8-in. sq. drive sockets

- 13 6-pt. inch (1/4 thru 1 in.)
- 17 6-pt. metric (6 thru 22 mm)
- 11 6-pt. inch deep (3/8 thru 1 in.)
- 11 6-pt. metric deep (9 thru 19 mm)
- 11 12-pt. inch deep (3/8 thru 1 in.)
- 13 12-pt. metric deep (9 thru 19, 21, 22 mm)
- 13 12-pt. inch (1/4 thru 1 in.)
- 13 12-pt. metric (8 thru 19, 21 mm)
- 5 8-pt. inch (1/4 thru 1/2 in.)
- 7 Screwdriver bits (7/32, 9/32, 3/8, #1, #2, #3, #4)
- 4 Torx® bits, (T-30, T-40, T-45, T-50)
- 6 Inch hex bits (5/32 thru 3/8 in.)
- 6 Metric hex bits, (4 thru 8, 10 mm)
- 4 Spark plug sockets (5/8, 13/16, 3/4 in. and 18 mm.)
- 4 Extension bars (1 1/2, 3, 6, 10 in.)
- 2 Adapters (1/4, 1/2 in.)
- 1 Quick-release long ratchet
- 1 Universal joint
- 1 10-inch flex T-handle

wrenches

- 36 Combination wrenches: 15 inch (1/4 thru 1 in., 1 1/8 x 1 in.); 21 metric (6 thru 26 mm)
- 20 Open end wrenches: 10 inch, 10 metric
- 16 Reversible full polish ratcheting combination wrenches: 8 inch (5/16 thru 1 1/8 in.), 8 metric (8, 10, 12 thru 15, 17, 18 mm)
- 16 Wrench sockets that complement the ratcheting wrenches: 8 inch (5/16 thru 3/4 in.); 8 metric (8, 10, 12 thru 15, 17, 18 mm)
- 16 Box end wrenches: 8 inch (1/4 x 5/16 thru 15/16 x 1 in.); 8 metric (6 x 8 thru 21 x 23 mm)
- 9 Flare nut: 4 inch (3/8 x 7/16, 1/2 x 9/16, 5/8 x 11/16, 3/4 x 7/8 in.); 5 metric (9 x 11, 10 x 12, 13 x 14, 15 x 17, 19 x 21 mm)
- 5 Tappet inch (3/8 x 7/16, 7/16 x 17/32, 1/2 x 9/16, 5/8 x 11/16, 3/4 x 7/8 in.)
- 1 Obstruction wrench (9/16 x 5/8 in.)

specialty tools

- 25 Screwdrivers: 8 Phillips, 11 slotted and 6 Torx®
- 14 Nut drivers, 7 inch and 7 metric
- 40-pc. Hex key set: 20 inch, 20 metric
- 1 6-inch long needle nose pliers
- 1 6 3/4-inch slip joint pliers

P See page 43 for more information. **W** Warranted, see page 94a. **N** See "N" suffix note on page 94a.

427-PIECE — PROFESSIONAL SET

Save \$100 when you buy "C" and "D"

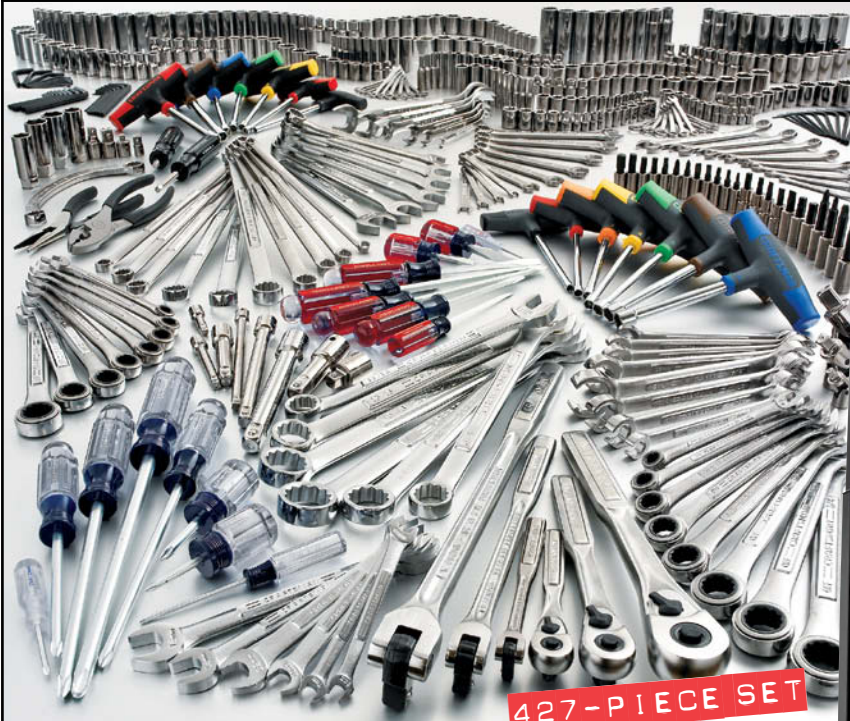

427-PIECE SET

C. OVER \$2,000 VALUE

Catalog/Online EXCLUSIVE

SAVE \$100 when you buy the complete combo "C" and "D" Craftsman 427-piece Professional Mechanic's Tool Set, 11-Drawer Combo in Black. Provides 14,491 cu. in. of storage. Separate prices total \$1,399.97. Wt. 276 lbs. 009-93313N ♦ Combo 1,299.97

427-piece mechanic's tool set

- 235 sockets • 23 drive tools
- 97 wrenches • 72 specialty tools

C. Craftsman 427-piece Professional Mechanic's Tool Set. Includes 14 new T-Handle nut drivers, 97 assorted wrenches, including ratcheting wrenches. Also includes 235 sockets and 16 screwdrivers. See chart on opposite page for complete listing. Separate prices total \$2,076.34. Guaranteed Forever!® Made in USA. Wt. 67.5 lbs. 009-83082 Set 799.99



D

D. Craftsman 11-Drawer Ball-Bearing GRIPLATCH® Combo in Black. 14,491 cu. in. of storage. See 009-59614 and 009-59615 on page 14 for details. Wt. 208.5 lbs. 009-95368N ♦ \$599.98



540-PIECE — PROFESSIONAL SET

Save \$100 when you buy "E" and "F"



540-PIECE SET

E. OVER \$2,500 VALUE



SEARS.COM/SHOPTOOLS

Sign up to be notified when items go on sale.

SAVE \$100 when you buy the complete combo "E" and "F" Craftsman 540-piece Professional Mechanic's Tool Set, 11-Drawer Combo in Red/Black. Provides 14,491 cu. in. of storage. Separate prices total \$1,899.97. Wt. 301.5 lbs. 009-41196N ♦ Combo 1,799.97

540-piece mechanic's tool set

- 271 sockets
- 27 drive tools
- 105 wrenches
- 67 specialty tools

F. Craftsman 540-piece Professional Mechanic's Tool Set. Set has an incredible 312 sockets and 105 assorted wrenches, including full polish reversible ratcheting wrenches and laser-etched wrench sockets. Also includes 24 screwdrivers and 14 nut drivers. See chart on opposite page for tools included. Separate prices total \$2,897.63. Guaranteed Forever!® Made in USA. Wt. 93 lbs. 009-36540 Set 1,299.99



F

F. Craftsman 11-Drawer Ball-Bearing GRIPLATCH® Combo in Red/Black. 14,491 cu. in. of storage. See 009-59714 and 009-59715 on page 14 for details. Wt. 208.5 lbs. 009-95758N ♦ \$599.98



METRIC AND INCH SETS

A.	NEW	OVER \$1,600 VALUE	273 PIECE SET
-----------	------------	---------------------------	----------------------



273-PIECE SET

Catalog/Online EXCLUSIVE

273-piece all-inch mechanic's tool set

• 153 sockets • 32 drive tools • 50 specialty tools • 38 wrenches

A. NEW Craftsman 273-piece All-Inch

Mechanic's Tool Set. Features 1/2-inch drive impact sockets. See chart for full list of tools. Separate prices total \$1,606.15. Made in USA. Guaranteed Forever!® Wt 62 lbs. 009-83087 **699.99**

Also Available

NEW Craftsman 273-piece All-Metric Mechanic's Tool Set. Features 1/2-inch drive impact sockets. See chart for full list of tools. Separate prices total \$1,611.65. Made in USA. Guaranteed Forever!® Wt 64 lbs. 009-83091 **699.99**

B.	NEW	OVER \$830 VALUE	201 PIECE SET
-----------	------------	-------------------------	----------------------



201-PIECE SET

Catalog/Online EXCLUSIVE

201-piece all inch mechanic's tool set

• 129 sockets • 20 drive tools • 16 wrenches • 36 specialty tools

A. 273-piece All-Inch Set 273-piece All-Metric Set

1/4-in. sq. drive sockets	1/4-in. sq. drive sockets
11 6-pt. inch (5/32 thru 9/16 in.)	12 6-pt. metric (4, 5, 5.5, 6 thru 14 mm)
10 12-pt. inch (3/16 thru 9/16 in.)	11 6-pt. metric deep (4 thru 14 mm)
10 6-pt. inch deep (3/16 thru 9/16 in.)	4 Extension bars (1 1/2, 3, 6, 14 in.)
4 Extension bars (1 1/2, 3, 6, 14 in.)	1 ea. Quick-release ratchet, universal joint, 3/8-inch adapter, spinner handle, extension socket, flex-spinner and speeder bar
1 ea. Quick-release ratchet, universal joint, 3/8-inch adapter, spinner handle, extension socket, flex-spinner and speeder bar	
3/8-in. sq. drive sockets	3/8-in. sq. drive sockets
13 6-pt. inch (1/4 thru 1 in.)	17 6-pt. metric (6 thru 22 mm)
5 8-pt. inch (1/4 thru 1/2 in.)	15 12-pt. metric (6 thru 19, 21 mm)
13 12-pt. inch (1/4 thru 1 in.)	11 6-pt. metric deep (9 thru 19 mm)
11 6-pt. inch deep (3/8 thru 1 in.)	13 12-pt. metric deep (9 thru 19, 21, 22 mm)
11 12-pt. inch deep (3/8 thru 1 in.)	4 Extension bars (1 1/2, 3, 6, 10 in.)
4 Extension bars (1 1/2, 3, 6, 10 in.)	2 Adapters (1/4, 1/2 in.)
2 Adapters (1/4, 1/2 in.)	1 ea. Quick-release ratchet, universal joint, 10-inch flex T-Handle, 7-inch slide bar, 16-in. speeder bar
1 ea. Quick-release ratchet, universal joint, 10-inch flex T-Handle, 7-inch slide bar, 16-in. speeder bar	
1/2-in. sq. drive sockets	1/2-in. sq. drive sockets
14 6-pt. inch (3/8 thru 1 1/4 in.)	14 6-pt. metric (9 thru 22 mm)
8 8-pt. inch (7/16 thru 3/4 in.)	24 12-pt. metric (9 thru 30, 32, 36 mm)
14 12-pt. inch (7/16 thru 1 1/4 in.)	12 12-pt. metric deep (13 thru 22, 24, 27 mm)
11 12-pt. inch deep (1/2 thru 1 1/8 in.)	12 6-pt. impact metric (12 thru 19, 21, 22, 24, 27 mm)
12 6-pt. impact inch (3/8 thru 1 1/16 in.)	12 6-pt. impact metric deep (12 thru 19, 21, 22, 24, 27 mm)
12 6-pt. impact inch deep (3/8 thru 1 1/16 in.)	3 Extension bars (2, 3, 6 in.)
3 Extension bars (2, 3, 6 in.)	2 Flex T-Handles (15, 18 in.)
2 Flex T-Handle (15, 18-in.)	1 ea. Quick-release ratchet, 3/8-inch adapter, universal joint, 18-in. speeder bar, 9-in. slide bar
1 ea. Quick-release ratchet, 3/8-inch adapter, universal joint, 18-in. speeder bar, 9-in. slide bar	
wrenches and specialty tools	wrenches and specialty tools
16 Combination wrenches (1/4 thru 1 1/8 in.)	16 Combination wrenches (6 thru 21 mm)
10 Combination ignition wrenches	10 Combination ignition wrenches
8 Combination ratcheting wrenches (5/16 thru 3/4 in.)	8 Combination ratcheting wrenches (10 thru 15, 18, 19 mm)
4 Flare nut wrenches (3/8 x 7/16 thru 3/4 x 7/8 in.)	4 Flare nut wrenches (9 x 11 thru 15 x 17 mm)
7 T-Handle nut drivers (3/16 thru 1/2 in.)	7 T-Handle nut drivers (5 thru 11 mm)
18 Screwdrivers: 6 slotted, 6 Phillips, 6 Torx®	18 Screwdrivers: 6 slotted, 6 Phillips, 6 Torx®
3 Pliers: 6 3/4-in. slip joint, 7-in. arc joint, 6-in. long needle nose	3 Pliers: 6 3/4-in. slip joint, 7-in. arc joint, 6-in. long needle nose
2 Hammers: 12 oz. ball pein; plastic tip	2 Hammers: 12 oz. ball pein; plastic tip
20 pc. Inch hex key kit	20 pc. Inch hex key kit

B. 201-piece All-Inch Set 201-piece All-Metric Set

1/4-in. sq. drive sockets	1/4-in. sq. drive sockets
11 6-pt. inch (5/32 thru 9/16 in.)	12 6-pt. metric (4, 5, 5.5, 6 thru 14 mm)
10 12-pt. inch (3/16 thru 9/16 in.)	11 6-pt. metric deep (4 thru 14 mm)
10 6-pt. inch deep (3/16 thru 9/16 in.)	3 Extension bars (1 1/2, 3, 6 in.)
3 Extension bars (1 1/2, 3, 6 in.)	1 ea. Quick-release ratchet, universal joint, 3/8-inch adapter
1 ea. Quick-release ratchet, universal joint, 3/8-inch adapter	
3/8-in. sq. drive sockets	3/8-in. sq. drive sockets
13 6-pt. inch (1/4 thru 1 in.)	17 6-pt. metric (6 thru 22 mm)
5 8-pt. inch (1/4 thru 1/2 in.)	15 12-pt. metric (6 thru 19, 21 mm)
13 12-pt. inch (1/4 thru 1 in.)	11 6-pt. metric deep (9 thru 19 mm)
11 6-pt. inch deep (3/8 thru 1 in.)	13 12-pt. metric deep (9 thru 19 mm, 21 and 22 mm)
11 12-pt. inch deep (3/8 thru 1 in.)	4 Extension bars (1 1/2, 3, 6, 10 in.)
4 Extension bars (1 1/2, 3, 6, 10 in.)	2 Adapters (1/4, 1/2 in.)
2 Adapters (1/4, 1/2 in.)	1 ea. Quick-release ratchet, universal joint
1 ea. Quick-release ratchet, universal joint	
1/2-in. sq. drive sockets	1/2-in. sq. drive sockets
14 6-pt. inch (3/8 thru 1 1/4 in.)	14 6-pt. metric (9 thru 22 mm)
8 8-pt. inch (7/16 thru 3/4 in.)	24 12-pt. metric (9 thru 30, 32, 36 mm)
14 12-pt. inch (7/16 thru 1 1/4 in.)	12 12-pt. metric deep (13 thru 22, 24, 27 mm)
11 12-pt. inch deep (1/2 thru 1 1/8 in.)	3 Extension bars (2, 3, 6 in.)
3 Extension bars (2, 3, 6 in.)	1 ea. Quick-release ratchet, 3/8-inch adapter, universal joint
1 ea. Quick-release ratchet, 3/8-inch adapter, universal joint	
wrenches and specialty tools	wrenches and specialty tools
12 Combination wrenches (1/4 thru 7/8 in.)	12 Combination wrenches (6 thru 17 mm)
4 Flare nut wrenches (3/8 x 7/16 thru 3/4 x 7/8 in.)	4 Flare nut wrenches (9 x 11 thru 15 x 17 mm)
1 Magnetic handle	1 Magnetic handle
10 pc. Screwdriver bit set	10 pc. Screwdriver bit set
5 pc. Nut driver bit set	5 pc. Nut driver bit set
20 pc. Hex key set	20 pc. Hex key set

B. NEW Craftsman 201-piece All Inch Mechanic's Tool Set. See chart for full list of tools. Separate prices total \$830.81. Made in USA. Guaranteed Forever!® Wt 34 lbs. 009-83095 **299.99**

Also Available

NEW Craftsman 201-piece All Metric Mechanic's Tool Set. See chart for full list of tools. Separate prices total \$865.01. Made in USA. Guaranteed Forever!® Wt 31.5 lbs. 009-83096 **299.99**

CRAFTSMAN

SPECIALIZED TOOLS FOR FIELD TECHNICIANS

MECHANIC'S TOOLS

C. 233-piece

1/4-in. sq. drive sockets

- 11 6-pt. inch sockets (5/32 thru 9/16 in.)
- 12 6-pt. metric sockets (4, 5, 5.5, 6 thru 14 mm)
- 10 6-pt. inch deep sockets (3/16 thru 9/16 in.)
- 11 6-pt. metric deep sockets (4 thru 14 mm)
- 7 Screwdriver bits: 2 slotted (5-6, 6-8); 2 Phillips (#1, #2); 3 Torx® bit sockets (T15, T20, T25)
- 4 Extension bars (1 1/2, 3, 6 and 14 inch)

- 1 ea. Quick-release ratchet, 6-inch spinner handle, universal joint, flex extension

3/8-in. sq. drive sockets

- 12 6-pt. inch sockets (1/4 thru 15/16 in.)
- 17 6-pt. metric sockets (6 thru 22 mm)
- 9 6-pt. inch deep sockets (3/16 thru 1/2 in.)
- 9 6-pt. metric deep sockets (9 thru 17 mm)
- 11 Screwdriver bits: 3 slotted (5-6, 8-10, 14-16); 4 Phillips (#1, #2, #3, #4); 4 Torx® bit sockets (T30, T40, T45, T50)
- 4 Extension bars (1 1/2, 3, 6, 10 in.)

- 1 ea. Quick-release long ratchet, universal joint, 1/4-inch adapter

wrenches, pliers and screwdrivers

- 12 Open-end Wrenches: 14 : 6 inch (1/4 x 5/16, 3/8 7/16, 1/2 x 9/16, 9/16 x 5/8, 5/8 x 3/4, 3/4 x 7/8, 6 metric (6 x 8 thru 16 x 18 mm))
- 6 45-degree full polish deep offset box-end: 3 inch (3/8 x 7/16 thru 5/8 x 11/16 in.), 3 metric (10 x 11 thru 13 x 15 in.);

- 20 pc. combination ignition (10 inch, 10 metric);
- 1 8-inch adjustable
- 10 Pliers: 5 needle nose (5-inch mini, 4 1/2-inch mini-bent, 6-inch bent, 4 1/2-inch mini long, 6-inch long); 2 diagonal cutting (4-inch mini, 5-inch); 6 3/4-inch slip joint, 7-inch arc joint, 5-inch ignition
- 8 Screwdrivers: 4 slotted (1/8 x 4, 3/16 x 4, 1/4 x 6, 1/4 x 12); 4 Phillips (#0 x 2 1/2, #1 x 3, #2 x 4, #3 x 6), 10 micro-tech

specialty tools

- 26-pc. Ball-end hex key set (13 inch, 13 metric)
- 6 Nut drivers, 6 inch (3/16 1/4, 5/16, 3/8, 7/16, 1/2
- 6 Nut drivers, 6 metric (5 thru 10 mm)
- 1 ea. 8-oz. ball-pein hammer, 12-ounce plastic tip hammer, 23-inch flexible pick-up tool, 2 1/4-inch inspection mirror, scratch awl, circuit tester, 36-blade combination gauge, cotter key extractor, 5/32 x 7 inch line-up punch, 1/2-inch center punch, 1/16-inch pin punch, 16-inch pry bar, slotted and Phillips screw starters

C.	OVER \$1,050 VALUE	233 PIECE SET
-----------	---------------------------	----------------------



233-PIECE SET



Catalog/Online EXCLUSIVE
233-piece field technician's tool set

- 109 sockets • 15 drive tools
- 39 wrenches • 70 specialty tools

C. Craftsman 233-piece Deluxe Field Technician's Tool Set. Our largest. Includes tools in chart at left. Separate prices total \$1,057.69. Guaranteed Forever!® Made in USA. Wt. 30.4 lbs.
009-34233499.99

Catalog/Online EXCLUSIVE
D. Craftsman Military-Ready Cart with TSA-Compliant Lock. Recessed 38 1/2 inch telescoping handle with one-touch release. Wraparound bumpers to absorb shocks. 3-inch inline red ball-bearing wheels, red aluminum frame and TSA 3-digit combination lock, measures 18W x 15D x 12H in. Wt. 15 lbs.
009-59780259.99

MORE TO EXPLORE
at sears.com!

E. 145-piece

1/4-in. sq. drive sockets

- 11 6-pt. inch (5/32 thru 9/16 in.)
- 11 6-pt. metric (4 thru 14 mm)
- 9 6-pt. inch deep (3/16 thru 1/2 in.)
- 9 6-pt. metric deep (4 thru 12 mm)
- 3 Torx® bit sockets (T15, T20, T25)
- 3 Extension bars (1 1/2, 3, 6 in.)

- 1 ea. Quick-release ratchet, 6-in. spinner handle

3/8-in. sq. drive sockets

- 10 6-pt. inch (3/8 thru 5/16 in.)
- 10 6-pt. metric (10 thru 19 mm)
- 3 Torx® bit sockets (T30, T40, T45)
- 3 Extension bars (1 1/2, 3, 6 in.)

- 1 ea. Quick-release long ratchet, universal joint

wrenches, pliers and screwdrivers

- 36 Wrenches: 26 open-end: 5 inch (1/4 x 5/16, 3/8 x 7/16, 1/2 x 9/16, 5/8 x 3/4, 3/4 x 7/8 in.), 5 metric (7 x 9 thru 17 x 19 mm); 20 combination ignition (10 inch, 10 metric); 6 45-degree full polish offset deep box-end: 3 inch (3/8 x 7/16 thru 5/8 x 11/16) and 3 metric (10 x 11 thru 13 x 15)

- 5 Pliers: 2 needle nose (4 1/2-inch mini-bent, 6-inch long), 5-inch diagonal cutting, 6 3/4-inch slip joint and 5-inch ignition
- 8 Screwdrivers: 4 slotted (1/8 x 4, 3/16 x 6, 1/4 x 12, 1/4 x 1 1/2 stubby); 4 Phillips (#0 x 2 1/2, #1 x 3, #2 x 4, #2 x 1 1/2 stubby)

specialty tools

- 14-pc. Ball-end hex key set (7 inch, 7 metric)
- 1 ea. 8-ounce ball-pein hammer, 23-inch flexible pick-up tool, 2 1/4-inch inspection mirror, scratch awl, circuit tester

E.	OVER \$600 VALUE	145 PIECE SET
-----------	-------------------------	----------------------



145-PIECE SET

Catalog/Online EXCLUSIVE
SAVE \$30 when you buy 145-piece Tool Set "E" with Case "F". Separate prices total \$399.98. Wt. 28 lbs.
009-41205369.98

F. Thermo Plastic Attaché Case for "E". With reinforced corners, two removable pallets. Measures 18W x 13D x 6H in. Tools not included. Wt. 11 lbs.
009-6500199.99

145-piece field technician's tool set

- 66 sockets • 11 drive tools
- 36 wrenches
- 32 specialty tools

Catalog/Online EXCLUSIVE
E. Craftsman 145-piece Field Technician's Tool Set. Includes tools in chart. Separate prices total \$603.96. Made in USA. Guaranteed Forever!® Wt. 17 lbs.
009-41203299.99



easy-read Dual-Mark sockets!

6-point sockets

Preferred by professionals, 6-point sockets maximize fastener surface contact for a more secure fit to minimize rounding over corners or slipping off a stubborn fastener.

Catalog/Online EXCLUSIVE

207-piece 6-pt. Dual-Mark mechanic's tool set featuring 22 impact sockets

- 162 sockets
- 6 drive tools
- 26 combination wrenches
- 13 specialty tools

A. Craftsman 207-piece 6-point Dual-Mark Mechanic's Tool Set with Dual-Mark Sockets. Featuring all 6-point Dual-Mark sockets and 6-point wrenches. Includes tools listed in chart at right. Separate prices total \$1209.13. Made in USA. Guaranteed Forever!® Wt. 37.5 lbs.

009-33207.....299.99

Catalog/Online EXCLUSIVE

124-piece 6-pt. Dual-Mark mechanic's tool set

- 72 sockets
- 5 drive tools
- 4 wrenches
- 43 specialty tools

B. NEW Craftsman 124-piece 6-point Dual-Mark Mechanic's Tool Set with Case. See chart at right for full list of tools. Separate prices total \$369.95. Made in USA. Guaranteed Forever!® Wt. 12.2 lbs.

009-83097.....99.99

SHOP ON THE GO!

Visit sears2go.com on your mobile device

C. 145-piece

1/4-in. sq. drive sockets

- 11 6-pt. inch (5/32 thru 9/16 in.)
- 12 6-pt. metric (4, 5, 5.5, 6 thru 14 mm)
- 10 6-pt. inch deep (3/16 thru 9/16 in.)
- 11 6-pt. metric deep (4 thru 14 mm)
- 1 3-inch extension bar
- 1 Quick-release ratchet

3/4-in. sq. drive sockets

- 13 6-pt. inch (1/4 thru 1 in.)
- 17 6-pt. metric (6 thru 22 mm)
- 11 6-pt. inch deep (3/8 thru 1 in.)
- 11 6-pt. metric deep (9 thru 19 mm)
- 1 5/8-inch spark plug socket
- 1 3-inch extension bar
- 1 Quick-release long ratchet

1/2-in. sq. drive sockets

- 15 6-pt. inch (3/8 thru 1 1/4 in.)
- 13 6-pt. metric (9 thru 22 mm)
- 1 3-inch extension bar
- 1 Quick-release ratchet

wrenches

- 14 Combination: 7 inch (3/8 thru 3/4 in.); 7 metric (12 thru 18 mm)

FEATURING ALL 6-POINT TOOLS

A. OVER \$1,200 VALUE INCLUDES 22 IMPACT SOCKETS



207-PIECE SET

B. NEW OVER \$350 VALUE



124-PIECE SET

C. OVER \$700 VALUE ALL STEEL SET



145-PIECE SET

A. 207-piece

1/4-in. sq. drive sockets

- 11 6-pt. inch (5/32 thru 9/16 in.)
- 12 6-pt. metric (4, 5, 5.5, 6 thru 14 mm)
- 10 6-pt. inch deep (3/16 thru 9/16 in.)
- 11 6-pt. metric deep (4 thru 14 mm)
- 1 Quick-release ratchet
- 1 3-inch extension bar

3/8-in. sq. drive sockets

- 13 6-pt. inch (1/4 thru 1 in.)
- 17 6-pt. metric (6 thru 22 mm)
- 9 6-pt. inch deep (3/8 thru 7/8 in.)
- 11 6-pt. metric deep (9 thru 19 mm)
- 1 Quick-release ratchet
- 2 Extension bars (3 and 6 inch)
- 2 Spark plug sockets (5/8, 3/16)

1/2-in. sq. drive sockets

- 14 6-pt. inch (3/8 thru 1 1/8, 1 1/4 in.)
- 14 6-pt. metric (12 thru 19, 21 mm)
- 9 6-pt. inch deep (1/2 thru 1 in.)
- 9 6-pt. metric deep (12 thru 19, 21 mm)
- 1 Quick-release ratchet
- 1 3-inch extension bar
- 14 Impact sockets: 7 inch (1/2 thru 3/16 and 15/16 in.), 7 metric (15 thru 19, 21 and 22 mm)
- 8 Deep impact sockets: 4 inch (1/2, 9/16, 5/8 and 11/16 in.), 4 metric (14 thru 17 mm)

wrenches & specialty tools

- 26 Combination wrenches: 12 inch (1/4 thru 7/8 in.), 14 metric (6 thru 19 mm)
- 2 Screwdrivers: (3/16 x 4 slotted and #2 Phillips)
- 8 Nut drivers: 4 inch (1/4, 5/16, 3/8, 7/16 in.), 4 metric (6, 7, 8, 10 mm)

B. 124-piece

1/4-in. sq. drive sockets

- 11 6-pt. inch (5/32 thru 9/16 in.)
- 12 6-pt. metric (4, 5, 5.5, 6-14 mm)
- 5 6-pt. inch deep (1/4-7/16 in.)
- 5 6-pt. metric deep (7-11 mm)
- 1 Quick-release ratchet
- 1 3 inch extension bar

3/8-in. sq. drive sockets

- 11 6-pt. inch (1/4-7/8 in.)
- 12 6-pt. metric (7-18 mm)
- 4 6-pt. inch deep (7/16-5/8 in.)
- 4 6-pt. metric deep (10, 12-14 mm)
- 1 ea. Quick-release long ratchet, 3-inch extension bar, 1/2-inch adapter

1/2-in. sq. drive sockets

- 4 6-pt. inch (9/16-3/4 in.)
- 4 6-pt. metric (15, 17-19 mm)

wrenches & specialty tools

- 4 Open-end wrenches: 2 inch (3/8 x 7/16, 1/2 x 9/16 in.), 2 metric (10 x 11, 12 x 14 mm)
- 20-pc. Inch hex key set
- 12-pc. Nut driver bit set: inch/metric
- 10-pc. Screwdriver bit set
- 1 Magnetic spinner handle

Catalog/Online EXCLUSIVE

145-piece 6-pt. Dual-Mark mechanic's tool set

- 125 sockets
- 6 drive tools
- 14 wrenches

C. Craftsman 145-piece "All Steel" Dual-Mark Mechanic's Tool Set with Dual-Mark Sockets and Convenient Storage Case. Built to withstand the toughest environment, these "full metal jacket" six-point sockets deliver strong fastener contact in a wide range of sizes. See chart at left for full tool listing. Separate prices total \$701.96. Made in USA. Guaranteed Forever!® Wt. 27.3 lbs.

009-34142.....179.99

*Warranted, see page 94a.

244-PIECE MECHANIC'S TOOL SET

D. 244-piece

D.	NEW	OVER \$800 VALUE	INCLUDES 42-PC. TOOL SET WITH ZIPPER CASE
----	-----	------------------	-------------------------------------------

1/4-in. sq. drive sockets

- 11 6-pt. inch (5/32 thru 9/16 in.)
- 12 6-pt. metric (4, 5, 5.5, 6 thru 14 mm)
- 10 12-pt. inch (3/16 thru 9/16 in.)
- 10 6-pt. inch deep (3/16 thru 9/16 in.)
- 11 6-pt. metric deep (4 thru 14 mm)
- 1 Quick-release ratchet
- 1 3-inch extension bar

3/8-in. sq. drive sockets

- 11 6-pt. inch (1/4 thru 7/8 in.)
- 17 6-pt. metric (6 thru 22 mm)
- 5 8-pt. inch (1/4 thru 1/2 in.)
- 10 12-pt. inch (5/16 thru 7/8 in.)
- 12 12-pt. metric (9 thru 19, 21 mm)
- 7 6-pt. inch deep (3/8 thru 3/4 in.)
- 9 6-pt. metric deep (9, 10, 12 thru 18 mm)
- 1 Quick-release long ratchet
- 2 Extension bars (3 and 6 inch)
- 1 1/4-inch adapter
- 2 Spark plug sockets (5/8, 13/16 inch)

1/2-in. sq. drive sockets

- 10 12-pt. inch (1/2 thru 1 1/16 in.)
- 12 12-pt. metric (9, 10, 12 thru 19, 21, 22 mm)
- 1 Quick-release ratchet
- 1 3-inch extension bar

wrenches & specialty tools

- 12 Combination wrenches inch (1/4 thru 7/8 in.)
- 12 Combination wrenches metric (8 thru 19 mm)
- 1 Magnetic handle
- 10-pc. Screwdriver bit set
- 12-pc. Nut driver bit set (Inch/Metric)
- 20-pc. Inch hex key set
- 20-pc. Metric hex key set
- 42-piece tool set



E NEW

Catalog/Online EXCLUSIVE

D and E. NEW Craftsman 244-piece Mechanic's Tool Set with 3-Drawer Lift Top Tool Chest and 42-piece Tool Set with Soft-Side Zippered Case.

An unbelievable value, this set features a wide variety of tools, plus a 42-piece tool set and a sturdy blow mold plastic tool chest with removable drawers. Set includes 149 inch and metric sockets, along with 3 quick-release ratchets, 4 extension bars, 24 combination wrenches and more. All packed in a durable case. Also includes a 42-piece soft-side tool set. Separate prices total \$852.02. Made in USA. Guaranteed Forever!® Wt. 28.8 lbs.

009-94681 249.99

E. NEW Craftsman 42-piece Tool Set with Soft-Side Zippered Case.

Set features 12 1/4-in. 6-point sockets (6 inch: 1/4 thru 7/16; and 6 metric: 7 thru 12); a quick-release ratchet; a 3/8-in. adapter; 10 3/8-in. 6-point sockets (5 inch: 1/2 thru 3/4; and 5 metric: 13 thru 18 mm); 2 open-end wrenches, 3/8 x 7/16 and 1/2 x 9/16; 4-piece screwdriver bit set with magnetic handle; and an 11-piece inch short hex key set. Separate prices total \$103.21. Made in USA. Guaranteed Forever!® Wt. 4.3 lbs.

009-33042 29.99

Catalog/Online EXCLUSIVE

181-piece mechanic's tool set with 14-pc. T-handle nut driver set, locking flex pry bar

- 108 sockets
- 6 drive tools
- 14 wrenches
- 53 specialty tools

F. NEW Craftsman 181-piece Mechanic's Tool Set with Case. This versatile set features a unique case that separates inch and metric sizes for easy size selection. See chart at right for full list of tools. Separate prices total \$662.13. Made in USA. Guaranteed Forever!® Wt. 30 lbs.

009-83049 199.99

009-83227 **P** Personalized 229.99

181-PIECE MECHANIC'S TOOL SET

F.	NEW	OVER \$660 VALUE	INCLUDES TRIFOLD CASE
----	-----	------------------	-----------------------



181-PIECE SET

F. 181-piece

1/4-in. sq. drive sockets

- 11 6-pt. inch (5/32 thru 9/16 in.)
- 12 6-pt. metric (4, 5, 5.5, 6 thru 14 mm)
- 8 6-pt. inch deep (3/16 thru 1/2 in.)
- 8 6-pt. metric deep (5 thru 12 mm)
- 1 Quick-release ratchet
- 1 3-inch extension bar

3/8-in. sq. drive sockets

- 11 6-pt. inch (1/4 thru 7/8 in.)
- 14 6-pt. metric (6 thru 19 mm)
- 9 12-pt. inch (1/4 thru 3/4 in.)
- 9 12-pt. metric (9 thru 17 mm)
- 7 12-pt. inch deep (3/8 thru 3/4 in.)
- 6 12-pt. metric deep (9, 10, 12 thru 15 mm)
- 1 Quick-release ratchet
- 2 Extension bars (3 and 6 inch)
- 1 5/8-inch Spark plug socket

1/2-in. sq. drive sockets

- 6 12-pt. inch (7/16 thru 3/4 in.)
- 6 12-pt. metric (13 thru 18 mm)
- 1 Quick-release ratchet

wrenches & specialty tools

- 7 Combination wrenches inch (1/4 thru 5/8 in.)
- 7 Combination wrenches metric (9 thru 15 mm)
- 7-pc. Inch T-handle nut drivers (3/16 thru 1/2-inch)
- 7-pc. Metric T-handle nut drivers (5 thru 11mm)
- 1 8-in. Locking flex pry bar
- 1 Magnetic handle
- 9-pc. Screwdriver bit set
- 14-pc. Inch hex key set
- 14-pc. Metric hex key set

217-PIECE — MECHANIC'S TOOL SET

A.	NEW	INCLUDES CRAFTSMAN GOLD TITANIUM FINISH THIN-PROFILE RATCHET	A \$39⁹⁹ VALUE
-----------	------------	---------------------------------------------------------------------	----------------------------------



Catalog/Online EXCLUSIVE
A. NEW Craftsman 217-piece Mechanic's Tool Set Includes Craftsman Gold Titanium Finish Thin-Profile Ratchet. This great set features a gold titanium finish thin-profile ratchet. Also included is a great assortment of tools in 1/4, 3/8, and 1/2-inch drives. These tools come in a newly-designed lift-top lid tool chest. Each drawer can be removed from the tool box, or locked in place with pivoting locking doors. Additional storage in the lid of the case. Separate prices total \$769.22. Made in USA. Guaranteed Forever!® Wt. 40.44 lbs.
009-87626.....199.99
P Personalized
009-87868.....249.99

A. 216-piece			
1/4-in. sq. drive sockets	3/8-in. sq. drive sockets	1/2-in. sq. drive sockets	specialty tools
11 6-pt. inch (5/32 thru 9/16 in.)	11 6-pt. inch (1/4 thru 7/8 in.)	10 12-pt. inch (1/2 thru 1 1/16 in.)	10-pc. Screwdriver bit set
12 6-pt. metric (4, 5, 5.5, 6 thru 14 mm)	17 6-pt. metric (6 thru 22 mm)	12 12-pt. metric (9, 10, 12 thru 19, 21, 22 mm)	12-pc. Nut driver bit set (inch/metric)
10 12-pt. inch (3/16 thru 9/16 in.)	5 8-pt. inch (1/4 thru 1/2 in.)	1 3 inch extension bar	1 Magnetic handle
10 6-pt. inch deep (3/16 thru 9/16 in.)	10 12-pt. inch (5/16 thru 7/8 in.)	1 Quick-release ratchet	11-pc. Inch Hex key set short
11 6-pt. metric deep (4 thru 14 mm)	12 12-pt. metric (9 thru 19, 21 mm)	1 3 inch extension bar	11-pc. Metric Hex key set short
1 Quick-release ratchet	7 6-pt. inch deep (3/8 thru 3/4 in.)	wrenches	
1 3 inch extension bar	9 6-pt. metric deep (9, 10, 12 thru 19 mm)	7 Inch combination wrenches (1/4 thru 5/8 in.)	1 Full polish gold titanium finish thin-profile 3/8-in. drive ratchet with pouch
	1 1/4 in. adapter	7 Metric combination wrenches (8 thru 10, 12 thru 15 mm)	
	1 Quick-release long ratchet		
	2 Extension bars (3, 6 in.)		
	2 Spark plug sockets (5/8, 13/16 in.)		

INCLUDES GOLD TITANIUM FINISH COLLECTIBLE RATCHET



B. 169-piece	
1/4-in. sq. drive sockets	3/8-in. sq. drive sockets
9 6-pt. inch sockets (7/32 thru 9/16 in.)	7 6-pt. inch sockets (3/8 thru 3/4 in.)
10 6-pt. metric sockets (5.5 thru 14 mm)	8 6-pt. metric sockets (10, 12 thru 18 mm)
5 6-pt. inch deep sockets (1/4 thru 7/16 in.)	5 6-pt. inch deep (3/8 thru 5/8 in.)
5 6-pt. metric deep sockets (7 thru 11 mm)	5 6-pt. metric deep (10 thru 14 mm)
1 Quick-release ratchet	8 12-pt. inch sockets (1/4 thru 3/4 in.)
1 Extension bar (3 in.)	11 12-pt. metric sockets (9 thru 19 mm)
	1 Quick-release ratchet
	1 Extension bar (3 in.)
	1 Spark plug socket (5/8 in.)
1/2-in. sq. drive sockets	wrenches
7 12-pt. inch sockets (3/4 thru 1 1/8 in.)	6 Combination wrenches: 3 inch (5/16, 3/8, 7/16 in.) 3 metric (8 thru 10 mm)
8 12-pt. metric sockets (17 thru 24 mm)	6 Ratcheting wrenches: 3 inch (7/16, 1/2, 9/16 in.) 3 metric (11 thru 13 mm)
1 Quick-release ratchet	
specialty tools	
40 Hex keys (20 inch, 20 metric)	
10-pc. Screwdriver bit set	
12-pc. Nut driver bit set (inch and metric)	
1 Magnetic bit driver	

169-PIECE — MECHANIC'S TOOL SET

B.	OVER \$570 VALUE	SET FEATURES 6 RATCHETING WRENCHES
-----------	-------------------------	-------------------------------------------



169-piece mechanic's tool set featuring all Dual-Mark sockets

- 89 sockets
- 5 drive tools
- 12 wrenches (6 ratcheting)
- 63 specialty tools

B. Craftsman 169-piece Mechanic's Tool Set with Six Ratcheting Wrenches and Dual-Mark Sockets. Heavy-duty ratcheting wrenches make completing your task much faster and easier. Set includes 89 popular sizes and features deep sockets in 1/4 and 3/8-inch sizes. Also includes quick-release thumb-reversing ratchets in 1/4, 3/8 and 1/2-inch sizes, six ratcheting wrenches and six combination wrenches. Hex keys, screwdriver and nut driver bit sets round out the set. See chart on left for set contents. Separate prices total \$570.99. Guaranteed Forever!® Wt. 23.9 lbs.
009-41197.....169.99

C. NEW Craftsman 63-piece Soft-Side Tool Set. Take-anywhere set includes zipper case, 14 1/4-in. drive inch and metric sockets, 12 3/8-in. drive inch and metric sockets, 3/8-in. ratchet, extension bar, 1/4-in. adapter, two open-end inch wrenches, magnetic bit handle with screwdriver and nut driver bits, 12 hex keys. Separate prices total \$131.65. Tools made in USA. Wt. 3.63 lbs.
009-87631.....49.99
P Personalized 009-87869.....79.99



C	NEW
----------	------------

*Warranted, see page 94a.
 P See page 43 for more information.

P Personalize it!

D. Craftsman 1/2-inch Electronic Torque Wrench, Now Available Personalized. Features strain gauge technology for ± 2% clockwise and ± 3% counterclockwise accuracy, large LCD display and color-coded LEDs that indicate when to slow torque application. Easy push-button operation adjusts from 20 to 200 ft.-lbs., 240 to 2,400 in.-lbs. and 27.1 to 271.2 Newton-meters. Includes case. (Batteries not included.) 90-day limited warranty*. Wt. 5.2 lbs.

009-47712 239.99
P Personalized 009-45286 254.99

NEW Craftsman 3/8-inch drive Electronic Torque Wrench, Now Available Personalized. Same features as the 1/2-inch wrench above, but adjusts from 10 to 100 ft.-lbs., 120 to 1,200 in.-lbs. and 13.6 to 135.6 Newton-meters. Includes storage case. (Batteries not included.) 90-day limited warranty*. Wt. 3.6 lbs.

009-47711 219.99
P Personalized 009-45285 234.99

E. Craftsman Microtork® Wrenches with Deluxe Case. Micrometer-type scales stamped into housing show torque settings in both inch and metric units. Accurate to ± 4 percent on clockwise or right-handed reading greater than or equal to 20 percent of capacity. Large handle easily turns to set torque. Case included. See chart below. Warranted*.

F. Craftsman Digitork® Torque Wrenches with Digital Readout and Deluxe Case. Gives precise torque settings in both inch and metric units. Accurate to ± 3 percent on clockwise or right-handed reading greater or equal to 20 percent of capacity. Handle designed for easy torque setting. Case included. See chart below. Warranted*.

Craftsman Torque Wrenches						
Catalog No.	Sq. drive	Measures	Increments	Wt., lbs.	Price	
E. Microtork® Wrenches						
009-44595	1/2 in.	20-150 ft.-lbs.	1 ft.-lb.	3.25	\$79.99	
P 009-45282	1/2 in.	20-150 ft.-lbs.	1 ft.-lb.	3.25	94.99	
009-44594	3/8 in.	10-75 ft.-lbs.	0.5 ft.-lb.	2.69	79.99	
P 009-45280	3/8 in.	10-75 ft.-lbs.	0.5 ft.-lb.	2.69	94.99	
009-44593	3/8 in.	25-250 in.-lbs.	1 in.-lb.	2.25	79.99	
P 009-45281	3/8 in.	25-250 in.-lbs.	1 in.-lb.	2.25	94.99	
F. Digitork® Wrenches						
009-44597	1/2 in.	25-250 ft.-lbs.	2 ft.-lb.	3.56	\$119.99	
P 009-45284	1/2 in.	25-250 ft.-lbs.	2 ft.-lb.	3.56	134.99	
009-44596	3/8 in.	5-80 ft.-lbs.	0.5 ft.-lb.	2.75	119.99	
P 009-45283	3/8 in.	5-80 ft.-lbs.	0.5 ft.-lb.	2.75	134.99	



Craftsman Torque Wrenches
 E and F feature internal mechanisms for accurate and consistent measurement and now can be personalized with your own message of up to two rows of twelve characters each.



features digital readout

includes case

includes case

HIGH TECH TOOLS FOR HIGH TECH TIRES



G NEW

adjustable torque scale

GEARWRENCH

Catalog/Online EXCLUSIVE G. NEW GearWrench® Tire Pressure Monitoring System Kit. Properly install and torque TPMS fasteners and valve cores. Includes an innovative, accurate and easy-to-use electronic torque wrench with adjustable torque scale and audible/visual alert, flexible tip for straight or 90-degree use, a valve stem torque tool, 1/4-in. drive 6-point deep 11 and 12 mm sockets. With blow molded case. Wt. 2 lbs.
 009-87655 149.99

H. Craftsman Beam-Style 75 lbs. Torque Wrench with 3/8 to 1/2-inch Adapter and Tray. Features foot-pound and Newton-meter scales. Accurate to 4 percent. Graduated indicator top for line-on-line reading. Beam style maintains calibration better than other wrenches when dropped. Wt. 1.13 lbs.
 009-44978 29.99

SHOP ON THE GO!
 Visit sears2go.com on your mobile device

Catalog/Online EXCLUSIVE J. Craftsman Professional Torque Wrenches. Accurate to ±3 percent, exceeds ASME standards. Slide pin design allows palming without ratchet reversing. Increment band color-coded to units of measure. Chemical-resistant comfort grip handle. NIST traceable calibration certification. See chart below. Two-year limited warranty*.

Catalog/Online EXCLUSIVE K. Craftsman Torque Screwdriver. ±6 percent accuracy meets or exceeds ASME B107.14M and ISO 6789 requirements. Range of 2 to 36 in.-lbs. with graduations every 2 in.-lbs., 0.2 to 4 Nm with graduations every 0.2 Nm Dual scale, inch and metric, 1/4-inch female hex drive. NIST Certificate included. Warranted*. Wt. 0.56 lb.
 009-34887 149.99

Craftsman Professional Torque Wrenches						
J. Catalog No.	Sq. drive	Measures	Increments	Wt., lbs.	Price	
009-34186	3/8 in.	30-150 in.-lbs.	2 in.-lbs.	1.75	\$164.99	
009-34881	3/8 in.	40 to 200 in.-lbs.	2 in.-lbs.	1.12	164.99	
009-34882	3/8 in.	4 to 20 Nm	0.2 Nm	1.12	164.99	
009-34883	3/8 in.	15 to 75 ft.-lbs.	0.5 ft.-lb.	1.5	174.99	
009-34884	3/8 in.	20 to 100 Nm	0.5 Nm	1.5	184.99	
009-34885	1/2 in.	30 to 150 ft.-lbs.	1 ft.-lb.	2	199.99	
009-34886	1/2 in.	40-200 Nm	1 Nm	2	199.99	
009-34187	1/2 in.	50-250 ft.-lbs.	2 ft.-lbs.	3.44	244.99	

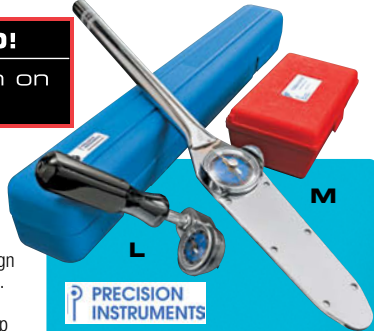

PRECISION INSTRUMENTS

L. Precision Instruments Dial Indicating Driver. Ideal where torque tolerance is tight. Accurate to 2% from 20% of scale to full scale. With a 1/4-inch female input square for a T-handle or ratchet and 1/4-inch male drive for 1/4-inch sockets or adapter. 75 in.-lbs. capacity. Wt. 1.8 lbs.
 009-44621 199.99

Catalog/Online EXCLUSIVE M. Precision Instruments Dial Type Torque Wrenches. Use when accuracy and durability are critical. Accurate to 2% from 20% of scale to full scale clockwise and counterclockwise, whatever the hand-hold position. Exclusive torsion bar connector allows the user to read the actual twist of the square drive. Compact design for clearance where space is limited.
 3/8-inch Sq. Dr. 150 in.-lbs. Wt. 1.85 lbs.
 009-44620 149.99
 3/8-inch Sq. Dr. 600 in.-lbs. Wt. 1.95 lbs.
 009-44622 159.99
 1/2-inch Sq. Dr. 250 ft.-lbs. Wt. 4.9 lbs.
 009-44623 199.99

Locking Flex Wrenches

Craftsman Locking Flex Ratcheting Wrenches... ratcheting heads rotate 180 degrees and lock in nine positions for improved access and ease of use.

A & B sets features locking flex ratcheting heads



CRAFTSMAN

A NEW

Catalog/Online EXCLUSIVE

A. NEW Craftsman 12-piece Full Polish Locking Flex Ratcheting Wrench Set with Deluxe Roll Pouch. Each wrench has a 180-degree head rotation with 11 positions; locks in 9 positions. Long handle for increased leverage with 5-degree ratcheting swing arc. Full polish for comfort and easy clean-up. Includes inch sizes 3/8, 7/16, 1/2, 9/16, 5/8, 3/4-in. and metric sizes 8, 10, 12, 13, 15, 17 mm. Includes 900-denier poly roll pouch. Separate prices total \$273.38. Made in USA. Guaranteed Forever!* Wt. 5.3 lbs.

009-83104199.99

Also Available

Craftsman 7-piece Full Polish Inch Locking Flex Wrench Set. Includes 7 inch wrenches: 5/16 thru 5/8, 3/4-inch. Separate prices total \$156.43. Wt. 3.19 lbs.

009-42400124.99

P Personalized 009-46942144.99

Craftsman 7-piece Metric Full Polish Locking Flex Wrench Set. Includes 7 metric wrenches: 8, 10, 12, 13, 15, 17, 19 mm. Separate prices total \$164.93. Wt. 3.19 lbs.

009-42401124.99

P Personalized 009-46943144.99

Catalog/Online EXCLUSIVE

B. NEW Craftsman 12-piece Full Polish Stubby Locking Flex Ratcheting Wrench Set with Deluxe Roll Pouch. Same innovation of locking flex wrench in a short version. Slim profile for access and speed. Includes inch sizes 3/8, 7/16, 1/2, 9/16, 5/8, 3/4-in. and metric sizes 8, 10, 12, 13, 15, 17 mm. Includes 900-denier poly roll pouch. Separate prices total \$273.38. Made in USA. Guaranteed Forever!* Wt. 3.7 lbs.

009-83105199.99

Also Available

Craftsman 7-piece Full Polish Inch Stubby Locking Flex Wrench Set. Includes 7 inch wrenches: 5/16 thru 5/8, 3/4-inch. Separate prices total \$164.93. Wt. 2.7 lbs.

009-42040124.99

P Personalized 009-44141144.99

Craftsman 7-piece Full Polish Metric Stubby Locking Flex Wrench Set. Includes 7 metric wrenches: 8, 10, 12, 13, 15, 17, 18 mm. Separate prices total \$164.93. Wt. 2.7 lbs.

009-42041124.99

P Personalized 009-44142144.99



B NEW

Reversible Ratcheting

Craftsman Reversible Ratcheting Wrenches combine a slim profile for easy access in tight spaces, an offset head for knuckle clearance and reversible mechanism for premium ratcheting.



The Craftsman® 28-piece Full Polish reversible ratcheting wrench and wrench socket set offers a slim profile for easy access in tight spaces.

Catalog/Online EXCLUSIVE

C. Craftsman 28-piece Full Polish Reversible Ratcheting Wrench and Wrench Socket Set. Wrench sockets are Laser-etched and provide additional reach and access to spaces too tight for a traditional ratchet and socket. Includes sizes 5/16, 3/8, 7/16, 1/2, 9/16, 5/8 and 3/4 in., and 8, 10, 12, 13, 14, 15 and 18 mm. Made in USA. Guaranteed Forever!* Sets sold separately total \$194.97. Wt. 5.06 lbs.

009-42122179.99

P Personalized 009-44073199.99

Catalog/Online EXCLUSIVE

D. SAVE *10 Craftsman 16-piece Full Polish Inch/Metric Wrench Socket Set. Set includes eight inch sockets (5/16 thru 3/4 in.) and eight metric sockets (8, 10, 12, 13, 14, 15, 17, 18 mm). Separate prices total \$59.98. Wt. 1.62 lbs.

009-4281649.98

Also Available

8-piece Full Polish Inch Wrench Socket Set. Includes eight inch sockets (5/16 thru 3/4 in.). Separate prices total \$33.92. Wt. 0.81 lb.

009-4280029.99

8-piece Full Polish Metric Wrench Socket Set. Set includes eight metric sizes (8, 10, 12, 13, 14, 15, 17 and 18 mm). Separate prices total \$33.92. Wt. 0.81 lb.

009-4280129.99

ratcheting wrench becomes a low profile ratchet

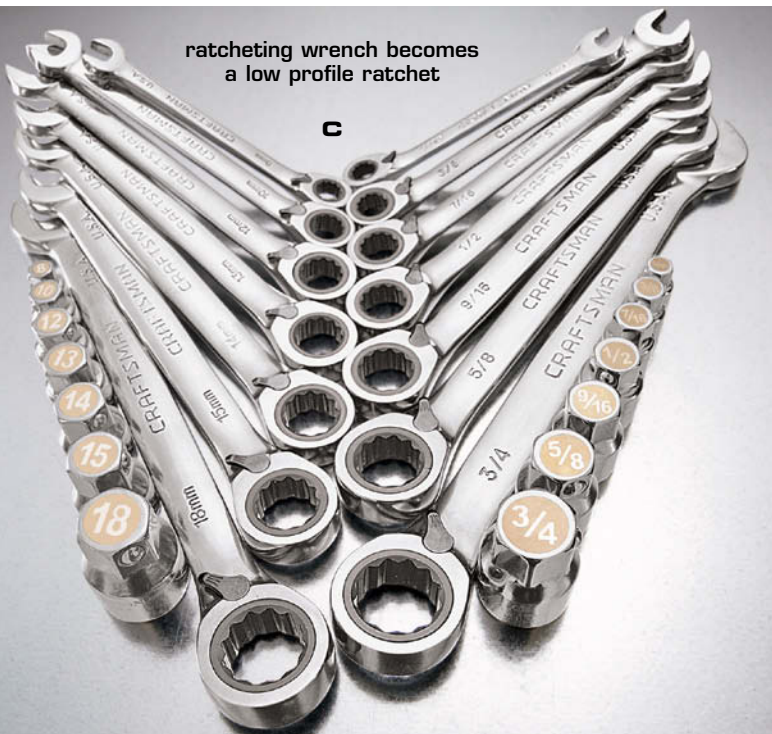

C

D

MORE TO EXPLORE

at sears.com!

*Warranted, see page 94a.

P See page 43 for more information.

INNOVATION YOU CAN FEEL - CROSS-FORCE™ RATCHETING WRENCHES

Catalog/Online EXCLUSIVE

E. SAVE \$30 Craftsman 14-piece 12-point Cross-Force™ Full Polish Reversible Ratcheting Combination Wrench Set. Our full polish Cross-Force™ design, now in a reversible ratcheting wrench, puts your hand on the flat portion for greater comfort. Enhanced access to tight spaces, added knuckle clearance and longer beam length for improved torque loading. Includes inch sizes 3/8, 7/16, 1/2, 9/16, 5/8, 11/16 in. and metric sizes 10, 12 thru 15, 17, 18 mm. Made in USA. Guaranteed Forever!™ Separate prices total \$249.98. Wt. 6.5 lbs.

009-47417229.98

P Personalized 009-47418259.98

Also Available

Craftsman 7-piece 12-point Inch Cross-Force™ Full Polish Reversible Ratcheting Combination Wrench Set. Includes inch sizes 3/8, 7/16, 1/2, 9/16, 5/8, 11/16, 3/4 in. Separate prices total \$171.93. Wt. 3.3 lbs.

009-44850124.99

P Personalized 009-47419144.99

Also Available

Craftsman 7-piece 12-point Metric Cross-Force™ Full Polish Reversible Ratcheting Combination Wrench Set. Includes metric sizes 10, 12 thru 15, 17, 18 mm. Separate prices total \$179.93. Wt. 3.1 lbs.

009-44851124.99

P Personalized 009-47420144.99



Reverse Ratcheting Innovation

Combine the comfort and torque of a Cross-Force™ wrench with the convenience and ease of a reverse ratcheting wrench.



Catalog/Online EXCLUSIVE

F Craftsman 14-piece Full Polish Reversible Ratcheting Wrench Set with Deluxe Roll Pouch. Includes sizes 5/16, 3/8, 7/16, 1/2, 9/16, 5/8, 3/4 in. and 8, 10, 12, 13, 14, 15, 18 mm. Comes with 900-denier polyester roll pouch. Separate prices total \$247.36. Made in USA. Guaranteed Forever!™ Wt. 3.6 lbs.

009-44035179.98

Also Available

Craftsman 8-piece Full Polish Reversible Ratcheting Inch Wrench Set. Includes sizes 5/16, 3/8, 7/16, 1/2, 9/16, 5/8, 11/16, 3/4 in. Separate prices total \$169.42. Wt. 3 lbs.

009-4240499.99

Craftsman 8-piece Full Polish Reversible Ratcheting Metric Wrench Set. Includes sizes 8, 10, 12, 13 thru 15, 17, 18 mm. Separate prices total \$151.43. Wt. 3 lbs.

009-4240599.99

Catalog/Online EXCLUSIVE

G. SAVE \$30 Craftsman 16-piece Full Polish Flat Ratcheting Wrench Set with Deluxe Roll Pouch. Includes inch and metric sizes 5/16 thru 3/4-inch and 8, 10, 12-15, 17, 18 mm. Includes 900-denier polyester roll pouch. Separate prices total \$179.98. Made in USA. Guaranteed Forever!™ Wt. 5.88 lbs.

009-42452149.98

Also Available

Craftsman 8-piece Full Polish Flat Ratcheting Inch Wrench Set. Includes 5/16, 3/8, 7/16, 1/2, 9/16, 5/8, 11/16 and 3/4 in. wrenches. Separate prices total \$137.43. Wt. 2.94 lbs.

009-4245089.99

Craftsman 8-piece Full Polish Flat Ratcheting Metric Wrench Set. Includes 8, 10, 12, 13, 14, 15, 17, 18 mm. wrenches. Separate prices total \$161.42. Wt. 2.94 lbs.

009-4245189.99



**RATCHETING WRENCH
OPEN STOCK AT
SEARS.COM/SHOPTOOLS**

Catalog/Online EXCLUSIVE

H. NEW—SAVE OVER 15% Craftsman 4-piece 4-in-One Inch and Metric Reverse Ratcheting 12-Point Wrench Set. Save time, money and space. One wrench does the work of four. Electrocoated and heat-treated for corrosion resistance and durability, with quick-reverse lever. Inch set: 5/16 x 3/8, 7/16 x 1/2, 9/16 x 5/8, 11/16 x 3/4 in. Metric set: 8 x 10, 12 x 13, 16 x 17, 18 x 19 mm. Separate set prices total \$59.98. Made in USA. Wt. 1.86 lbs.

009-8787649.99

Also Available

4-in-One Wrench Set—Inch. Wt. 0.94 lb. 29.99

009-4250029.99

4-in-One Wrench Set—Metric. Wt. 0.92 lb. 29.99

009-4250129.99



H NEW

Heavy-Duty Pawless

Craftsman Heavy-Duty Pawless Ratcheting Wrenches feature a large tooth profile for maximum gear contact and ratchet strength, a patented gear configuration that eliminates slack for faster turning, and a grease-free design that safeguards against the effects of dirt and solvents.



large tooth profile and grease-free design



both sets include 900-denier pouch



Catalog/Online EXCLUSIVE

A. Craftsman 14-piece Pawless Ratcheting Wrench Set with Deluxe Roll Pouch. Designed for heavy-duty projects, with a large tooth profile for maximum gear contact. Includes inch sizes 3/8, 7/16, 1/2, 9/16, 5/8, 11/16, 3/4 in. and metric sizes 10 thru 15, 18 mm. Includes 900-denier polyester roll pouch. Made in USA. Guaranteed Forever!® Wt. 4.9 lbs.

009-42435 99.98

Also Available

Craftsman 8-piece Inch Pawless Ratcheting Wrench Set. Includes inch sizes 5/16 thru 3/4 in. Wt. 2.06 lbs.

009-42444 59.99

Craftsman 8-piece Metric Pawless Ratcheting Wrench Set. Includes metric sizes 8, 10 thru 15, 18 mm. Wt. 2.11 lbs.

009-42445 59.99

Catalog/Online EXCLUSIVE

B. SAVE 10 Craftsman 8-piece Double Box-End Pawless Ratcheting Wrenches with Deluxe Roll Pouch. Each box-end features a different size. Grease-free design and large profile provides maximum inner gear contact and wrench strength. Innovative design eliminates slack for greater efficiency. Inch sizes include 5/16 x 3/8, 7/16 x 1/2, 9/16 x 5/8, 11/16 x 3/4 in. Metric sizes include 8 x 10, 12 x 13, 15 x 17, 18 x 19 mm. Includes 900-denier roll pouch. Separate prices total \$99.98. Made in USA. Guaranteed Forever!® Wt. 3.3 lbs.

009-44190 89.98

Also Available

Craftsman 4-piece Double Box-End Pawless Ratcheting Inch Wrench Set. Includes 4 inch wrenches listed above. Separate prices total \$65.96. Wt. 2.06 lbs.

009-42446 49.99

Craftsman 4-piece Double Box-End Pawless Ratcheting Metric Wrench Set. Includes 4 metric wrenches listed above. Separate prices total \$65.96. Wt. 2.11 lbs.

009-42447 49.99

*Warranted, see page 94a.

▶ See page 43 for more information.



**BUY ONLINE
PICK-UP IN STORE!**
on eligible items



C. Craftsman 4-piece Inch Tappet Set.

For tight areas requiring a thin-head wrench. Sizes 3/8 x 7/16, 1/2 x 9/16, 5/8 x 11/16, 3/4 x 7/8 in. Includes tote. Separate prices total \$44.56. Made in USA. Guaranteed Forever!® Wt. 1.38 lbs.

009-44189 25.99

Catalog/Online EXCLUSIVE

D. NEW Craftsman 21-piece Inch and Metric Crowfoot Wrench Sets. Use with 3/8-inch drive tools. Includes eleven inch sizes (3/8 thru 1 inch) and ten metric sizes (10 thru 19 mm). Separate prices total \$157.79. Guaranteed Forever!® Wt. 2.4 lbs.

009-83106 89.99

Also Available

10-piece Crowfoot Wrench Sets.

Inch Set. Sizes 3/8 thru 7/8 and 1 in. Comes with storage pouch. Wt. 1.25 lbs.

009-4362 49.99

Metric Set. Sizes 10 thru 19 mm. Comes with storage pouch. Wt. 0.94 lb.

009-4363 49.99

Catalog/Online EXCLUSIVE

E. NEW Craftsman Complete 44-piece Ignition Wrench Set. Mini tools, tough and efficient for precise work in tight spaces. Includes 20 combinations: 10 inch, (5/32 thru 7/16 in.), 10 metric (4, 4.5, 5, 5.5, 6 thru 11 mm). 16 open end: eight inch (7/32 thru 7/16 in.), eight metric (5, 5.5, 6 thru 11 mm), eight box end: four inch (3/16 x 13/64, 7/32 x 15/64, 1/4 x 9/32, 5/16 x 11/32 in.) and four metric (4.5 x 5, 5.5 x 6, 6 x 7, 8 x 9 mm). Made in USA. Guaranteed Forever!® Wt. 1.44 lbs.

009-43047 49.99

Also Available

Catalog/Online EXCLUSIVE

Craftsman 20-piece Combination Ignition Wrench Set with Deluxe Pouch. Set includes 10 inch (5/32 thru 7/16 in.) and 10 metric (4, 4.5, 5, 5.5, 6 thru 11). Wt. 1 lb.

009-47979 31.99

Catalog/Online EXCLUSIVE

F. Craftsman 9-piece, 6-pt. Flare Nut Wrench Set. Grips multiple sides of fasteners without rounding. Four inch sizes (3/8 x 7/16, 1/2 x 9/16, 5/8 x 11/16, 3/4 x 7/8 in.); five metric (9 x 11 mm, 10 x 12 mm, 13 x 14 mm, 15 x 17 mm, 19 x 21 mm). Separate prices \$123.01. Guaranteed Forever!® Wt. 2.5 lbs.

009-44096 39.99

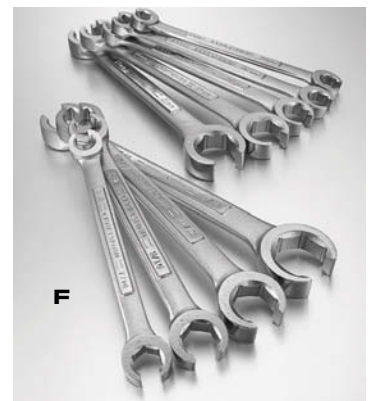



CRAFTSMAN



G. OVER \$340 VALUE

J. OVER \$340 VALUE

innovative ergonomic twist!
longer handle

Catalog/Online EXCLUSIVE
G. Craftsman 26-piece Full Polish 12-point Cross-Force™ Combination Wrench Set.

Our new larger sizes make this our biggest set ever! Includes inch sizes 5/16, 3/8, 7/16, 1/2, 9/16, 5/8, 11/16, 3/4, 13/16, 7/8, 15/16, 1, 1 1/8 in. and metric sizes 8, 10, 12 thru 15, 17 thru 22, 24 mm. Made in USA. Guaranteed Forever!® Separate prices total \$539.74. Wt. 17.9 lbs.

009-47796 329.96
P Personalized 009-47797 359.96

Catalog/Online EXCLUSIVE
H. Craftsman 10-piece Full Polish 12-point Cross-Force™ Large Size Combination Wrench Set.

Includes inch sizes 13/16, 7/8, 15/16, 1, 1 1/8 in. and metric sizes 19 thru 22, 24 mm. Separate prices total \$287.90. Wt. 13.4 lbs.

009-47798 199.98
P Personalized 009-47799 219.98

Catalog/Online EXCLUSIVE
J. NEW Craftsman 9-piece Inch Full Polish Cross-Force™ Combination Wrench Set.

Includes sizes 5/16 thru 13/16 in. Separate prices total \$150.91. Wt. 3.9 lbs.

009-83107 99.99
P Personalized 009-83108 119.99

Also Available
Catalog/Online EXCLUSIVE
NEW Craftsman 9-piece Metric Full Polish Cross-Force™ Combination Wrench Set.

Includes sizes 8, 10, 12 thru 15, 17 thru 19 mm. Separate prices total \$148.91. Wt. 3.3 lbs.

009-83110 99.99
P Personalized 009-83111 119.99

Also Available
Craftsman 16-piece Full Polish 12-point Cross-Force™ Combination Wrench Set.

Includes inch sizes 5/16, 3/8, 7/16, 1/2, 9/16, 5/8, 11/16, 3/4, in. and metric sizes 8, 10, 12 thru 15, 17, 18 mm. Separate prices total \$251.84. Wt. 10.4 lbs.

009-44874 149.98
P Personalized 009-44867 179.98



P Personalize it!

Cross-Force™ Innovation You Can Feel
 The long, ergonomic handle on this wrench offers a more comfortable grip and additional leverage. The 15-degree offset box offers more knuckle clearance. The 12-point box provides easier fastener engagement. Full polish finish for easy clean-up.



Catalog/Online EXCLUSIVE
K. Craftsman 11-piece Full Polish Flare Nut Wrench Set.

Oversized surfaces grip multiple sides to reduce rounding. For aluminum, copper and brass hex fittings. Inch sizes: 1/4 x 5/16, 3/8 x 7/16, 1/2 x 9/16, 5/8 x 11/16, 3/4 x 7/8 and metric: 9 x 11, 10 x 12, 13 x 14, 15 x 17, 16 x 18, and 19 x 21. Separate prices total \$209.89. Made in USA. Guaranteed Forever!® Wt. 3.03 lbs.

009-42104 74.99

Also Available
Craftsman 5-piece Inch Flare Nut Wrench Set.

With 1/4 x 5/16, 3/8 x 7/16, 1/2 x 9/16, 5/8 x 11/16, 3/4 x 7/8 in. Wt. 1.31 lbs.

009-42012 34.99

Craftsman 5-piece Metric Flare Nut Wrench Set.

With 9 x 11, 10 x 12, 13 x 14, 15 x 17, 16 x 18 mm wrenches. Wt. 1.27 lbs.

009-42013 34.99



L. NEW Craftsman 10-piece Fractional Crowfoot Flare Nut Wrench Set.

With 3/8 thru 1-in. wrenches. Includes 6-inch wobble extension. Wt. 1.65 lbs.

009-79554 79.99

Also Available
NEW Craftsman 10-piece Metric Crowfoot Flare Nut Wrench Set.

With 10 thru 19 mm wrenches. Includes 6-inch wobble extension. Wt. 1.65 lbs.

009-79555 79.99

M. Craftsman Obstruction Wrench.

Ideal for manifolds and starters. 12-pt. openings in 9/16 and 5/8 inch sizes. Measures 7 1/4 inches long. Made in USA. Guaranteed Forever!® Wt. 0.4 lb.

009-4376 16.99



FIND COMPLETE OPEN STOCK FOR SPECIALTY WRENCHES AT SEARS.COM/SHOPTOOLS



A. OVER \$230 VALUE

Catalog/Online EXCLUSIVE

A. Craftsman 28-piece, 6-pt. Combination Wrench Set. Includes every 6-pt. combination wrench we offer.

Includes 14 inch sizes (1/4, 5/16, 11/32, 3/8, 7/16, 1/2, 9/16, 5/8, 11/16, 3/4, 13/16, 7/8, 15/16 and 1 in.) and 14 metric sizes (6 thru 19 mm). Separate prices total \$231.42. Made in USA. Guaranteed Forever!® Wt. 8.31 lbs.

009-44098 **99.99**

Catalog/Online EXCLUSIVE

B. Craftsman 14-piece 6-pt. Inch Combination Wrench Set with Deluxe 900-Denier Polyester Roll Pouch. Set includes inch sizes: 1/4, 5/16, 11/32, 3/8, 7/16, 1/2, 9/16, 5/8, 11/16, 3/4, 13/16, 7/8, 15/16 and 1 in. Separate prices total \$126.06.

Wt. 5.64 lbs. **009-44480** **59.99**

Also Available
14-piece 6-pt. Metric Combination Wrench Set with Deluxe 900-Denier Polyester Roll Pouch. Includes all 6-pt. sizes: 6 thru 19 mm. Separate prices total \$105.36. Wt. 2.43 lbs.

009-44481 **59.99**



All 6-pt., up to 1 inch standard or 19 mm metric, store in a 900-denier polyester roll pouch.

B. OVER \$125 VALUE



C. Craftsman 12-piece, 6-pt. Inch Combination Wrench Set.

Featuring a 6-pt. box end, which is the number of contact points that meet the fastener. Set includes sizes 1/4, 5/16, 11/32, 3/8, 7/16, 1/2, 9/16, 5/8, 11/16, 3/4, 13/16 and 7/8 in. Made in USA. Guaranteed Forever!® Regular separate prices total \$96.08. Wt. 3.6 lbs.

009-47236 **39.99**

Also Available

Craftsman 12-piece, 6-pt. Metric Combination Wrench Set. Includes sizes 7, 8, 9, 10, 11, 12, 13, 14, 15, 16, 17 and 18 mm. Made in USA. Guaranteed Forever!® Regular separate prices total \$89.58. Wt. 2.7 lbs.

009-47237 **39.99**

Catalog/Online EXCLUSIVE

D. NEW Craftsman 18-piece Combination Inch Wrench Set. A broad range of inch combination wrenches. Set includes sizes 1/4, 5/16, 11/32, 3/8, 7/16, 1/2, 9/16, 5/8, 11/16, 3/4, 13/16, 7/8, 15/16, 1, 1 1/16, 1 1/8, 1 1/4, 1 5/16 in. Separate prices total \$219.02. Made in USA. Guaranteed Forever!® Wt. 12 lbs.

009-87642 **79.99**

Also Available

NEW Craftsman 18-piece Combination Metric Wrench Set. Our most popular sizes of metric combination wrenches. Set includes sizes 7 thru 19, 21, 22, 24, 27, 32 mm. Separate prices total \$188.12. Made in USA. Guaranteed Forever!® Wt. 8.44 lbs.

009-87643 **79.99**

Catalog/Online EXCLUSIVE

E. Martin Tools 18-piece 15- and 60-Degree Angle Head Hydraulic Wrench Set. For assembly, adjustment and repair of hydraulic systems, servo units, electrical components. Made in USA.

Inch Set. Includes sizes 11/32, 3/8, 7/16, 1/2, 9/16, 5/8, 11/16, 3/4, 13/16, 7/8, 15/16, 1, 1 1/16, 1 1/8, 1 1/4, 1 3/8, 1 7/16 and 1 1/2 in. Wt. 9.5 lbs.

009-33108 **379.99**

Also Available

Metric Set. Includes sizes 9 thru 19, 21, 22, 24, 27, 32, 34 and 36 mm. Wt. 9.5 lbs.

009-30148 **379.99**

Also Available

Martin Tools 11-piece Hydraulic Wrench Set. Includes sizes 3/8 thru 1 in. Wt. 3.3 lbs.

009-33109 **179.99**

Catalog/Online EXCLUSIVE

F. Martin Tools 11-piece 30-Degree Angle Head Service Wrench Set. Thin head is designed for close quarters work on pumps, valves and servo units. Chrome finish. Non-slip grip. Made in USA.

Inch Set. Includes sizes 3/4, 13/16, 7/8, 15/16, 1, 1 1/16, 1 1/8, 1 3/16, 1 1/4, 1 3/8 and 1 1/2 in. Wt. 4.08 lbs.

009-33107 **189.99**

Also Available

Metric Set. Includes sizes 19, 21, 22, 24, 27, 30, 32, 36, 37, 38, 40 mm. Wt. 4.08 lbs.

009-30147 **229.99**

C. OVER \$90 VALUE

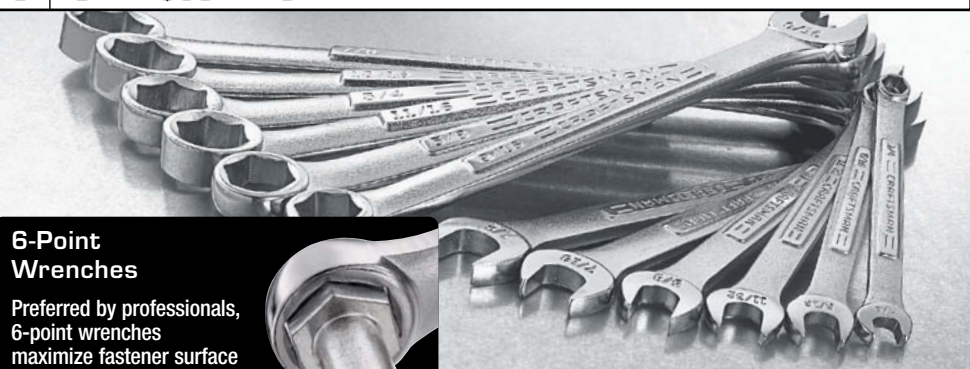

6-Point Wrenches

Preferred by professionals, 6-point wrenches maximize fastener surface contact for a more secure fit to minimize rounding over corners or slipping off a stubborn fastener.



SEE ALL COMBINATION WRENCH OPEN STOCK AT SEARS.COM/SHOPTOOLS

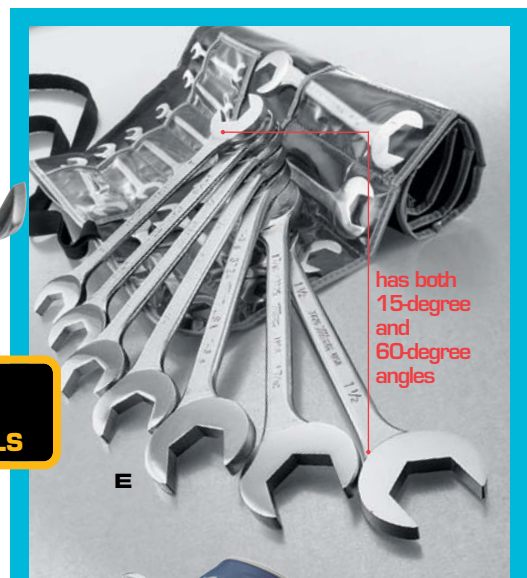

has both 15-degree and 60-degree angles



30-degree angle

D. NEW

G. OVER \$190 VALUE

Catalog/Online EXCLUSIVE

G. Craftsman 14-piece Inch Combination Wrench Set with Deluxe 900-Denier Polyester Roll Pouch.

Sizes 3/8, 7/16, 1/2, 9/16, 5/8, 11/16, 3/4, 13/16, 7/8, 15/16, 1, 1 1/16, 1 1/8 and 1 1/4 inch. Includes 900-denier polyester roll pouch. Separate prices total \$190.05. Made in USA. Guaranteed Forever!® Wt. 10.19 lbs.

009-4449079.99

Also Available

Craftsman 14-piece Metric Combination Wrench Set with Deluxe 900-Denier Polyester Roll Pouch.

Sizes 8, 10, 12, 13, 15, 17 thru 20, 22, 24, 27, 28 and 32 mm. Includes 900-denier polyester roll pouch. Separate prices total \$185.05. Made in USA. Guaranteed Forever!® Wt. 9.44 lbs.

009-4449179.99



MECHANIC'S TOOLS

our largest 12-point set

J. OVER \$500 VALUE

Catalog/Online EXCLUSIVE

J. Craftsman 43-piece Combination Wrench Set. Featuring our largest size wrenches – up to 18 1/4 inches long, all 12-pt. 18 inch sizes: 1/4, 5/16, 11/32, 3/8, 7/16, 1/2, 9/16, 5/8, 11/16, 3/4, 13/16, 7/8, 15/16, 1, 1 1/16, 1 1/8, 1 1/4, 1 5/16 in. and 25 metric sizes: 6 thru 28, 30, 32 mm. Separate prices total \$514.37. Made in USA. Guaranteed Forever!® Wt. 25.5 lbs.

009-44048199.99

L. Craftsman 26-piece 12-pt. Combination Wrench Sets.

Includes blow-molded case. Made in USA. Guaranteed Forever!®

Inch Set. Includes 16 sizes (1/4 thru 1 1/8 in.), and 10 ignition wrenches. Separate prices total \$182.03. Wt. 10.02 lbs.

009-4693569.99

Also Available

Metric Set. Includes 16 sizes (7 thru 22 mm), and 10 ignition wrenches. Separate prices total \$153.63. Wt. 8.18 lbs.

009-4693669.99

M. Craftsman 5-piece 12-pt. Combination Wrench Sets.

Lengths up to 18 1/4 inches. Includes blow-molded case for largest wrenches. Made in USA. Guaranteed Forever!®

Inch Set. Includes five sizes (1, 1 1/16, 1 1/8, 1 1/4, and 1 5/16 in.). Separate prices total \$108.95. Wt. 7.4 lbs.

009-4693964.99

Also Available

Metric Set. Includes five sizes (22 thru 25 and 30 mm). Separate prices total \$82.55. Wt. 5.1 lbs.

009-4694064.99

Catalog/Online EXCLUSIVE

10-piece 12-pt. Combination Wrench Set without Case. This set includes all 10 of the large wrenches listed above. Separate prices total \$191.58. Wt. 11.5 lbs.

009-4447999.98



includes case



M



H. OVER \$220 VALUE

H. Craftsman 32-piece Combination Wrench Set.

Includes inch and metric sizes, all 12 pt. Set includes 11 inch sizes (3/8 thru 1 inch), 11 metric sizes (10 thru 20 mm) and 10 ignition wrenches (five inch, five metric). Includes sturdy case. Separate prices total \$222.67. Made in USA. Guaranteed Forever!® Wt. 12.34 lbs.

009-4693779.99

K. Craftsman 12-piece 12-pt. Inch Combination Wrench Set.

Includes inch sizes: 1/4, 5/16, 11/32, 3/8, 7/16, 1/2, 9/16, 5/8, 11/16, 3/4, 13/16 and 7/8 in. Separate prices total \$96.08. Wt. 3.69 lbs.

009-4704639.99

Also Available

Craftsman 12-piece Metric Combination Wrench Set.

Includes all 12-pt. sizes: 7 thru 18 mm. Separate prices total \$89.58. Warranted*.

Wt. 2.81 lbs. 009-4704739.99

Craftsman 9-piece Inch Combination Wrench Set.

Includes inch sizes: 1/4, 5/16, 11/32, 3/8, 7/16, 1/2, 9/16, 5/8 and 3/4 in. Separate prices total \$62.61. Wt. 2.1 lbs.

009-4704429.99

Craftsman 9-piece Metric Combination Wrench Set.

Includes all 12-pt. sizes: 7, 8, 10 thru 16 mm. Separate prices total \$64.01. Warranted*.

Wt. 2 lbs. 009-4704529.99



K. OVER \$90 VALUE



L. OVER \$150 VALUE

*Warranted, see page 94a.



box-end wrenches

A. OVER \$400 VALUE

Catalog/Online EXCLUSIVE

A. Craftsman 28-piece Inch and Metric Box-End Wrench Set. Box-end means less chance of rounding fastener. 13 inch: 1/4 x 5/16, 3/8 x 7/16, 7/16 x 1/2, 1/2 x 9/16, 9/16 x 5/8, 19/32 x 25/32, 5/8 x 3/4, 11/16 x 13/16, 3/4 x 7/8, 15/16 x 1, 1 1/16 x 1 1/4, 1 1/8 x 1 5/16, 1 7/16 x 1 1/2 in. 15 metric: 6 x 8, 7 x 9, 10 x 11, 12 x 14, 13 x 15, 16 x 18, 17 x 19, 20 x 22, 21 x 23, 22 x 24, 24 x 26, 25 x 28, 27 x 30, 28 x 32, 30 x 32 mm. Separate prices total \$424.22. Wt. 22.6 lbs.

009-42962 179.99

Also Available

Craftsman 11-piece Inch Box-End Wrench Set. Sizes: 1/4 x 5/16, 3/8 x 7/16, 7/16 x 1/2, 1/2 x 9/16, 9/16 x 5/8, 5/8 x 3/4, 11/16 x 13/16, 3/4 x 7/8, 15/16 x 1, 1 1/16 x 1 1/4, 1 1/8 x 1 5/16 in. Separate prices total \$158.89. Wt. 6.94 lbs.

009-04985 59.99

Also Available

Craftsman 11-piece Metric Box-End Wrench Set. Sizes: 6 x 8, 7 x 9, 10 x 11, 12 x 14, 13 x 15, 16 x 18, 17 x 19, 21 x 23, 22 x 24, 25 x 28, 27 x 30 mm. Separate prices total \$145.89. Wt. 5.75 lbs.

009-04986 59.99

Catalog/Online EXCLUSIVE

B. Craftsman 5-piece Huge Box-End Inch Set. Sizes: 3/4 x 7/8, 15/16 x 1, 1 1/16 x 1 1/4, 1 1/8 x 1 5/16, 1 7/16 x 1 1/2 in. Separate prices \$116.95. Wt. 9.44 lbs.

009-43092 49.99

Catalog/Online EXCLUSIVE

Also Available

Craftsman 5-piece Huge Box-End Metric Set. Sizes: 24 x 26, 25 x 28, 27 x 30, 28 x 32, 30 x 32 mm. Separate prices total \$102.95. Wt. 6.88 lbs.

009-43093 49.99

Catalog/Online EXCLUSIVE

C. Craftsman 28-piece Inch and Metric Open-End Wrench Set. 14 inch sizes: 1/4 x 5/16, 3/8 x 7/16, 1/2 x 9/16, 9/16 x 5/8, 19/32 x 11/16, 5/8 x 3/4, 11/16 x 13/16, 3/4 x 7/8, 25/32 x 13/16, 15/16 x 1, 1 1/16 x 1 1/8, 1 1/4 x 1 5/16, 1 3/8 x 1 7/16, 1 1/2 x 1 5/8 in. 14 metric sizes: 6 x 8, 7 x 9, 10 x 11, 12 x 14, 13 x 15, 16 x 18, 17 x 19, 20 x 22, 21 x 23, 22 x 24, 24 x 26, 25 x 27, 28 x 30, 30 x 32 mm. Separate prices total \$356.22. Wt. 20.56 lbs.

009-42955 159.99



huge box-end wrenches... our 5 largest sizes

B. OVER \$400 VALUE



open-end wrenches

C. OVER \$350 VALUE

Catalog/Online EXCLUSIVE

D. Craftsman Open-End Wrench Sets in 900-Denier Polyester Roll Pouches. Loaded with huge sizes. All wrenches are heat-treated, oil-quenched and tempered for hardness and strength. Guaranteed Forever!*

Craftsman 14-piece Inch Open-End Set. 1/4 x 5/16, 3/8 x 7/16, 1/2 x 9/16, 9/16 x 5/8, 19/32 x 11/16, 5/8 x 3/4, 25/32 x 13/16, 11/16 x 13/16, 3/4 x 7/8, 15/16 x 1, 1 1/16 x 1 1/8, 1 1/4 x 1 5/16, 1 3/8 x 1 7/16 and 1 1/2 x 1 5/8 in. Separate prices total \$213.85. Wt. 13.6 lbs.

009-47311 94.99

Craftsman 14-piece Metric Open-End Set. 6 x 8, 7 x 9, 10 x 11, 12 x 14, 13 x 15, 16 x 18, 17 x 19, 20 x 22, 21 x 33, 22 x 24, 24 x 26, 25 x 27, 28 x 30 and 30 x 32 mm. Separate prices total \$168.35. Wt. 9.37 lbs.

009-47312 94.99

Catalog/Online EXCLUSIVE

E. Craftsman 5-piece Huge Open-End Inch Wrench Set. Includes sizes: 15/16 x 1, 1 1/16 x 1 1/8, 1 1/4 x 1 5/16, 1 3/8 x 1 7/16, 1 1/2 x 1 5/8 in. Separate prices total \$127.45. Wt. 9.13 lbs.

009-43090 49.99

Catalog/Online EXCLUSIVE

Also Available

Craftsman 5-piece Huge Open-End Metric Wrench Set. Includes sizes 22 x 24, 24 x 26, 25 x 27, 28 x 30, 30 x 32 mm. Separate prices total \$81.95. Wt. 5.81 lbs.

009-43091 49.99

>> SHOP ON THE GO!
Visit sears2go.com on your mobile device

open-end wrenches



D. OVER \$160 VALUE



E

FULL POLISH, OPEN END AND BOX END WRENCH OPEN STOCK AT SEARS.COM/SHOOTOOLS

FULL POLISH WRENCHES

MECHANIC'S TOOLS

Catalog/Online EXCLUSIVE

F. SAVE *30 Craftsman Professional 26-piece Full Polish Combination Wrench Set.

Includes the most often used wrenches. 13 inch (1/4 thru 1 in.) and 13 metric (7 thru 19 mm). Separate prices total \$199.98. Made in USA. Guaranteed Forever!*

Wt. 9.15 lbs.
009-34951 169.98

Also Available

Craftsman Professional Full Polish 13-piece Long-Pattern Wrench Sets. 12-pt. openings. Made in USA. Guaranteed Forever!*

Craftsman Professional Inch Set. Includes 13 inch wrenches up to 13 7/8 inches in length. Sizes 1/4 to 1 in. Separate prices total \$149.67. Wt. 5.81 lbs.

009-45963 99.99

Craftsman Professional Metric Set. Includes 13 metric wrenches up to 11 inches in length. Sizes 7 to 19 mm. Separate prices total \$146.17. Wt. 3.5 lbs.

009-45964 99.99

Catalog/Online EXCLUSIVE

G. Craftsman Professional 14-piece Full Polish Inch Wrench Set with 900-Denier Pouch.

Sizes 5/16 thru 1 1/8 in. Separate prices total \$204.65. Tools made in the USA. Guaranteed Forever!*

Wt. 9.13 lbs.
009-47313 129.99

Also Available

Craftsman Professional 14-piece Full Polish Metric Wrench Set with 900-Denier Pouch. Sizes 9 thru 15, 17 thru 19, 22 thru 25 mm. Separate prices total \$235.15. Tools made in the USA. Guaranteed Forever!*

Wt. 7.37 lbs.
009-47314 129.99

H. Craftsman Professional 5-piece Huge Full Polish Wrench Set with Blow-Molded Fitted Case.

15-degree chamfered box end helps "lead" wrench to fastener. Precision broaching for tight fit. Extra steel at end stress points. 12-pt. openings. Flat panel design. Made in USA. Guaranteed Forever!*

Craftsman Professional Inch Set. Five wrenches up to 19 3/8 inches in length. Sizes 1 1/16 thru 1 1/2 in. Separate prices total \$153.95. Wt. 14.21 lbs.

009-45965 129.99

Also Available

Craftsman Professional Metric Set. Five wrenches up to 16 3/8 inches in length. Sizes 22 thru 25, 30 mm. Separate prices total \$140.95. Wt. 7.63 lbs.

009-45966 129.99

Catalog/Online EXCLUSIVE

J. Craftsman Professional 20-piece Full Polish Inch and Metric Stubby Wrench Set.

Designed to get in tight workspaces. Includes 10 inch (3/8 thru 15/16 in.), 10 metric (10, 12 thru 20 mm) sizes. Separate prices total \$178.40.

Wt. 4.22 lbs.
009-34956 99.99

Also Available

Craftsman Professional 11-piece Inch Stubby Wrench Set. Sizes 3/8 thru 1 in. Separate prices total \$106.89.

Wt. 3.31 lbs.
009-44138 64.99

Craftsman Professional 11-piece Metric Stubby Wrench Set. Sizes 10, 12 thru 15, 17 thru 22 mm. Separate prices total \$104.99.

Wt. 2.81 lbs.
009-44139 64.99

Catalog/Online EXCLUSIVE

K. Craftsman Professional 12-piece Full Polish 45-Degree Deep Offset Inch and Metric Box-End Wrench Set.

Deep wrenches get at tucked-in or hard-to-reach fasteners. Five inch wrenches: 3/8 x 7/16, 1/2 x 9/16, 5/8 x 11/16, 3/4 x 7/8 and 13/16 x 15/16 in. Seven metric wrenches: 10 x 11, 12 x 14, 13 x 15, 16 x 18, 17 x 19, 20 x 22 and 21 x 23 mm. Separate prices total \$191.98. Warranted.*

Wt. 6.06 lbs.
009-46999 79.99

Also Available

Craftsman Professional 5-piece Full Polish Inch Deep 45-Degree Offset Wrench Set. Sizes include 3/8 x 7/16,

1/2 x 9/16, 5/8 x 11/16, 3/4 x 7/8, 13/16 x 15/16 in. Separate prices total \$78.25. Wt. 2.44 lbs.

009-44349 41.99

Also Available

Craftsman Professional 5-piece Full Polish Metric Deep 45-Degree Offset Wrench Set. Sizes include 10 x 11,

12 x 14, 13 x 15, 16 x 18, 17 x 19 mm. Separate prices total \$71.25. Wt. 1.88 lbs.

009-44350 41.99



F. OVER \$190 VALUE

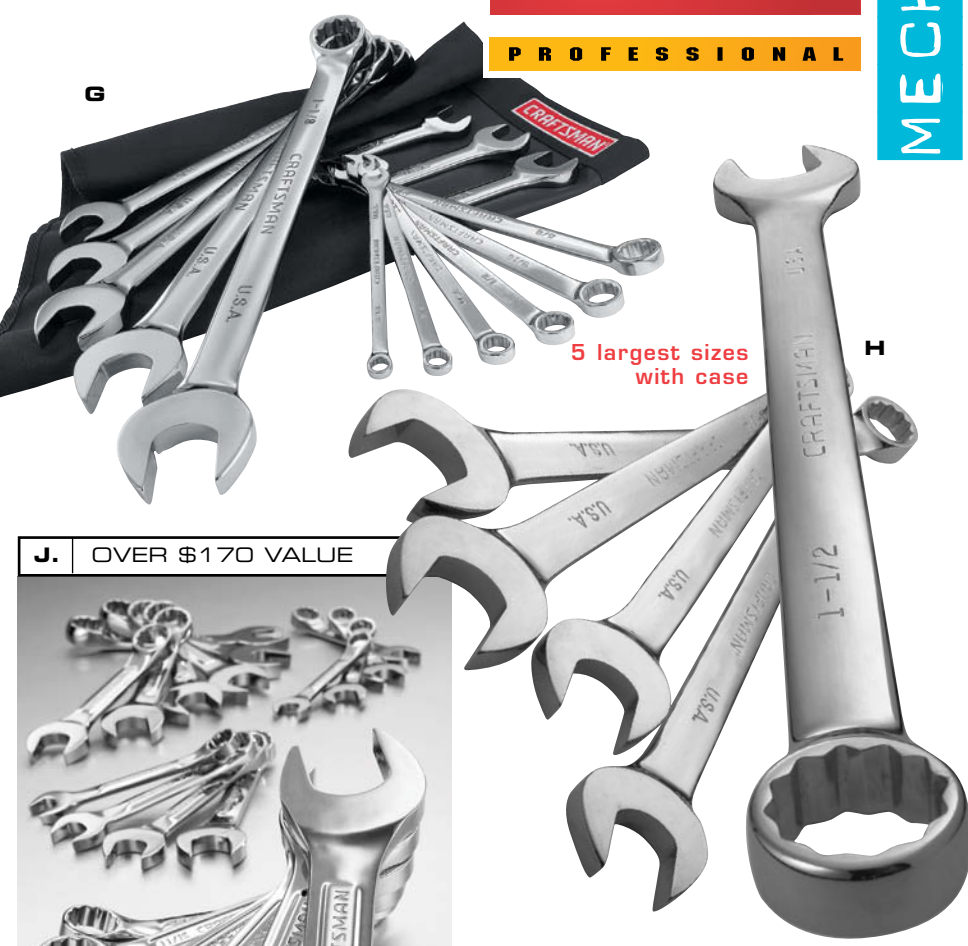

J. OVER \$170 VALUE

K. OVER \$190 VALUE





7-pc. inch & metric set available online



B NEW



C

Catalog/Online EXCLUSIVE

A. NEW-SAVE *20 GearWrench® 14-piece X-Beam Flex Combination Ratcheting Wrench Set. Flex head tilts 180 degrees at any interval to reach into tight places. Needs as little as 5 degrees of sweep to move a fastener vs. a standard box end wrench, which requires 30 degrees. Surface Drive Plus™ provides a stronger grip on fasteners while reducing rounding. Work with flat, wider side of the wrench for more power and less hand stress. Slim head design allows access into small spaces. Up to 25% longer than a standard GearWrench® ratcheting wrench to increase access into hard-to-reach fasteners. Set includes inch sizes 3/8, 7/16, 1/2, 9/16, 5/8, 11/16, 3/4 in. and metric sizes 8, 10, 12, 13, 14, 17, 19 mm. Separate prices total \$199.98. Wt. 9.1 lbs.

009-94679 179.98

Also Available

GearWrench® 7-piece Inch X-Beam Flex Combination Ratcheting Wrench Set. Set includes inch sizes 3/8, 7/16, 1/2, 9/16, 5/8, 11/16, 3/4 in. Wt. 4.8 lbs.

009-10021 99.99

GearWrench® 7-piece Metric X-Beam Flex Combination Ratcheting Wrench Set. Set includes metric sizes 8, 10, 12, 13, 14, 17, 19 mm. Wt. 4.3 lbs.

009-10022 99.99

Catalog/Online EXCLUSIVE

B. NEW-SAVE *20 GearWrench® 14-piece X-Beam Combination Ratcheting Wrench Set. Needs as little as 5 degrees of sweep to move a fastener vs. a standard box end wrench, which requires 30 degrees. Surface Drive Plus™ provides a stronger grip on fasteners while reducing rounding. Work with flat, wider side of the wrench for more power and less hand stress. Slim head design allows access into small spaces. Up to 25% longer than a standard GearWrench® ratcheting wrench to increase access into hard-to-reach fasteners. Set includes inch sizes 3/8, 7/16, 1/2, 9/16, 5/8, 11/16, 3/4 in. and metric sizes 8, 10, 12, 13, 14, 17, 19 mm. Separate prices total \$159.98. Wt. 8.8 lbs.

009-94680 139.98

Also Available

GearWrench® 7-piece Inch X-Beam Combination Ratcheting Wrench Set. Set includes inch sizes 3/8, 7/16, 1/2, 9/16, 5/8, 11/16, 3/4 in. Wt. 4.6 lbs.

00944280 79.99



E

GearWrench® 7-piece Metric X-Beam Combination Ratcheting Wrench Set. Set includes metric sizes 8, 10, 12, 13, 14, 17, 19 mm. Wt. 4.2 lbs.

009-44281 79.99

Catalog/Online EXCLUSIVE

C. SAVE *10 GearWrench® Full Polish 11-piece Flex Flare Nut Wrench Set. Double-sided, full polish, this versatile set features a 180-degree flexible head for improved access to tight spaces. Set includes inch sizes 1/4 x 5/16, 7/8 x 7/16, 1/2 x 9/16, 5/8 x 11/16, 3/4 x 7/8 in. and metric 9 x 11, 10 x 12, 13 x 14, 15 x 17, 16 x 18, 19 x 21 mm. Wt. 3.5 lbs.

009-44494 159.98

Catalog/Online EXCLUSIVE

D. SAVE *40 GearWrench® Full Polish Reversible 9-piece "Half-Moon" Shaped Box Ratcheting Wrench Set. Streamlined shape offers access. Ratcheting action for ease of use and speed. Box end provides two compatible sizes on each wrench. Requires as little as 5 degrees of sweep. Surface drive "O" box helps prevent rounding of fasteners. Includes inch sizes 3/8 x 7/16, 1/2 x 9/16, 5/8 x 11/16, 3/4 x 7/8 in. and metric sizes 10 x 12, 11 x 13, 14 x 16, 15 x 17, 19 x 22 mm. Separate set prices total \$289.98 on sears.com. Wt. 4.1 lbs.

009-44076 249.98

Catalog/Online EXCLUSIVE

E. SAVE *40 GearWrench® Full Polish Reversible 9-piece "S" Shaped Box Ratcheting Wrench Set. Each tool has four reversing levers—two on each side. Streamlined shape for better access. Ratcheting action for ease and speed. Box end provides two compatible sizes on each wrench. Needs as little as 5 degrees of sweep to move a fastener. Includes inch sizes 3/8 x 7/16, 1/2 x 9/16, 5/8 x 11/16, 3/4 x 7/8 in. and metric sizes 10 x 12, 11 x 13, 14 x 16, 15 x 17, 19 x 22 mm. Separate set prices total \$289.98 on sears.com. Wt. 4.1 lbs.

009-44045 249.99

Catalog/Online EXCLUSIVE

F. NEW-SAVE *30 GearWrench® 7-piece Quad Box Reversible Ratcheting Wrench Set. A compact, convenient way to get 28 wrench sizes into 7 wrenches. Each end of a wrench provides two different sizes with ratcheting action—4 sizes per wrench. Set includes inch sizes 5/16 + 3/8 x 7/16 + 1/2, 9/16 + 5/8 x 11/16 + 3/4, 13/16 + 7/8 x 15/16 + 1 in.; and metric sizes 8 + 10 x 12 + 13, 9 + 11 x 14 + 15, 16 + 17 x 18 + 19, 20 + 21 x 22 + 24 mm. Separate prices total \$229.98. Wt. 4.13 lbs.

009-94677 199.98



F NEW

3-pc. inch & 4-pc. metric set available online

Also Available
GearWrench® 3-piece Inch Quad Box Reversible Ratcheting Wrench Set. Set includes inch sizes 5/16 + 3/8 x 7/16 + 1/2, 9/16 + 5/8 x 11/16 + 3/4, 13/16 + 7/8 x 15/16 + 1 in. Wt. 1.94 lbs.

009-87659 99.99

GearWrench® 4-piece Metric Quad Box Reversible Ratcheting Wrench Set. Set includes metric sizes 8 + 10 x 12 + 13, 9 + 11 x 14 + 15, 16 + 17 x 18 + 19, 20 + 21 x 22 + 24 mm. Wt. 2.19 lbs.

009-87660 129.99

Catalog/Online EXCLUSIVE

G. GearWrench® Full Polish Quad Box Square HVAC Reversible Ratcheting Wrench. Set includes square sizes 1/4 x 3/16, 3/8 x 5/16 in. Wt. 0.2 lb.

009-44455 15.99

Catalog/Online EXCLUSIVE

H. GearWrench® Full Polish Quad Box Square and Hex HVAC Reversible Ratcheting Wrench. Set includes square sizes 1/4 x 3/16 and hex sizes 1/2 x 9/16 in. Wt. 0.3 lb.

009-44456 19.99



D



G

H



J NEW

J. NEW-SAVE \$15 GearWrench® 2-piece Cushion Grip Roto Ratchet Set. New-style ratchet provides 360 degrees of access. Fine tooth gear of 72 teeth operates in 5 degrees of swing arc. Gives you access to ratchet around obstructions that are in the way of the swing arc. Set includes 1/4 inch and 3/8 inch drive ratchets. Separate prices total \$64.98 on sears.com. Wt. 1.13 lbs.

009-87661 49.98

Catalog/Online EXCLUSIVE

K. SAVE \$20 GearWrench® 3-piece Cushion-Grip Teardrop Full Polish Ratchet Set. Features low profile performance head with flush-mounted lever. Longer cushioned handle delivers more leverage and improved comfort. Includes teardrop ratchets in 1/4, 3/8 and 1/2-inch drive sizes. Separate prices total \$139.99 on sears.com. Wt. 2.3 lbs.

009-44911 119.99

Also Available

GearWrench® 2-piece Cushion-Grip Flex Head Full Polish Ratchet Set. Same features as above, with flexible head for improved access in tight spaces. Includes ratchets in 1/4 and 3/8-inch drive sizes. Wt. 1.4 lbs.

009-44910 99.99

L. GearWrench® 27-piece XL Pass-Thru Ratchet Set with Flex GearRatchet® 1/4-inch Drive Handle.

Eliminates the need for deep sockets. Features a 50% thinner profile head with only a 5-degree ratcheting arc. Handle has a one-touch release for 11 locking positions. Includes Vortex inch sockets 5/32, 3/16, 7/32, 1/4, 9/32, 5/16, 3/8, 7/16, 1/2, 9/16 in.; metric 3.5, 4, 4.5, 5, 5.5, 6 thru 13 mm. Also includes 3- and 6-inch Vortex extensions, 1/4-inch square drive quick-release adapter, and Locking Flex GearRatchet® handle. Comes with case. Wt. 1.1 lbs.

009-44913 49.99

Also Available

GearWrench® 23-piece XL Pass-Thru Ratchet Set with Flex GearRatchet® 3/8-inch Drive Handle. Includes Vortex inch sockets 3/8, 7/16, 1/2, 9/16, 5/8, 11/16, 3/4, 13/16, 7/8 in.; metric 10 thru 19 mm. Also includes 3- and 6-inch Vortex extensions, 3/8-inch square drive quick-release adapter, and Locking Flex GearRatchet® handle. Comes with case. Wt. 2.8 lbs.

009-44914 79.99

GearWrench® 25-piece XL Pass-Thru Ratchet Set with Flex GearRatchet® 1/2-inch Drive Handle. Includes Vortex inch sockets 5/8, 11/16, 3/4, 7/8, 13/16, 15/16, 1, 1 1/16, 1 1/8, 1 1/4 in.; metric 15 thru 22, 24, 27, 30, 32 mm. Also includes 6-inch Vortex extension, 1/2-inch square drive quick-release adapter, and Locking Flex GearRatchet® handle. Comes with case. Wt. 7.3 lbs.

009-44915 119.99

Catalog/Online EXCLUSIVE

M. NEW-SAVE \$15 GearWrench® 9-piece Magnetic Master Accessory Set. Fits to all shallow sockets, and holds fasteners inside the socket to allow for application in hard-to-reach areas. Tools are made with strong neodymium magnets, which are the strongest magnets in the world—over 10 times stronger than ceramic magnets. Set includes 1/4 in. drive universal joint, 6 in. extension bar, 3/8 in. adapter; 3/8 in. drive universal joint, 6 in. extension bar, 1/2 in. adapter; and 1/2 in. drive universal joint, 6 in. extension bar, 3/8 in. adapter. Separate prices total \$74.97. Wt. 2 lbs.

009-87666 59.97



K



L



M NEW



P



N NEW



Q NEW

MORE TO EXPLORE
at sears.com!

Also Available

NEW GearWrench® 3-piece Magnetic Universal Joint Set. Includes three universal joints, one in each drive size: 1/4, 3/8, and 1/2 inch drives. Wt. 0.63 lb.

009-87667 24.99

GearWrench® 3-piece Magnetic Extension Bar Set. Includes three 6-inch extension bars one in each drive size: 1/4, 3/8, 1/2 inch drives. Wt. 1.13 lbs.

009-87668 24.99

GearWrench® 3-piece Magnetic Adapter Set. Includes three adapters: 3/8 in. x 1/4 in. drive, 1/2 in. x 3/8 in. drive and 3/8 in. x 1/2 in. drive. Wt. 0.31 lb.

009-87669 24.99

N. NEW GearWrench® 10-piece Ball End Long Torx® Bit Socket Accessory Set. Ball end feature allows access at multiple angles. Set includes 1/4 in. drive sizes T8, T10, T15, T20, T25, T27, T30, and 3/8 in. drive sizes T40, T45, T50. Wt. 1.69 lbs.

009-87665 44.99

Catalog/Online EXCLUSIVE

P. GearWrench® 39-piece Vortex Bit Socket Set 1/4 inch and 3/8 inch Drive. For use with the GearWrench® Pass-Thru Ratchet or any square drive ratchet. Features slotted, Phillips, Torx® and hexagon bit sockets.

1/4-inch drive sizes include #1, #2, #3 Phillips; 1/8, 3/16, 1/4 in. slotted; T8, T10, T15, T20, T25, T27, T30 Torx®; 1/16, 5/64, 3/32, 7/64, 1/8 in. hex; and 2, 2.5, 3 mm. 3/8-inch drive sizes include T40, T45, T47, T50, T55 Torx®; 9/64, 5/32, 3/16, 7/32, 1/4, 5/16, 3/8 in. inch; and 4 thru 8, 10 mm. Comes with case. Wt. 9.8 lbs.

009-44912 49.99

Catalog/Online EXCLUSIVE

Q. NEW-SAVE \$10 GearWrench® 14-piece Ball End Hex Bit Socket Accessory Set. Ball end feature allows access at multiple angles. Set includes inch sizes 1/8, 5/32, 3/16, 7/32, 1/4, 5/16, 3/8 in., and metric sizes 4, 5, 6, 7, 8, 9, 10 mm. Separate prices total \$59.98. Wt. 1.81 lbs.

009-87662 49.98

Also Available

NEW GearWrench® 7-piece Inch Ball End Hex Bit Socket Accessory Set. Includes inch sizes 1/8, 5/32, 3/16, 7/32, 1/4, 5/16, 3/8 in. Wt. 0.94 lb.

009-87663 29.99

NEW GearWrench® 7-piece Metric Ball End Hex Bit Socket Accessory Set. Includes metric sizes 4, 5, 6, 7, 8, 9, 10 mm. Wt. 0.94 lb.

009-87664 29.99

COMPLETE ASSORTMENT OF GEARWRENCH PRODUCTS AT SEARS.COM/SHOPTOOLS

*Warranted, see page 94a.
◆ See "N" suffix note on page 94a.



A NEW

**ALL 1/4, 3/8, 1/2 & 3/4-INCH/METRIC
OPEN STOCK SOCKETS
AT SEARS.COM/SHOPTOOLS**

All Catalog/Online EXCLUSIVES

A. NEW Craftsman 12-piece 3/4-inch Drive Inch Socket Accessory Set. Includes socket sizes 7/8, 15/16, 1, 1 1/16, 1 1/8, 1 3/16, 1 1/4, 1 5/16, 1 3/8, 1 7/16, 1 1/2, 1 5/8 in. Separate prices total \$199.88. Made in USA. Wt. 9 lbs.

009-83112 **99.99**
P Personalized 009-83113 **129.99**

Also Available
Craftsman 15-piece 3/4-inch Drive Metric Socket Accessory Set. 15 12-pt. sockets (19 thru 30, 32, 36, and 38 mm). Separate prices total \$284.85. Wt. 9.81 lbs.
009-83114 **129.99**

Catalog/Online EXCLUSIVE
B. Craftsman 24-piece Inch 3/4-inch Socket Wrench Set. 20 12-pt. sockets (7/8 thru 2 1/4 in.); quick-release ratchet; 5, 8 and 16-inch extension bars. Comes in a blow-molded case. Separate prices total \$563.76. Wt. 38 lbs.

009-83121 **299.99**
P Personalized 009-83122 **329.99**

Also Available
Craftsman 22-piece 3/4-inch Drive Metric Socket Wrench Set. 18 12-pt. sockets (19 thru 30, 32, 35, 36, 38, 41 and 42 mm); quick-release ratchet; 5, 8 and 16-inch extension bars. Comes in a blow-molded case. Separate prices total \$511.78. Wt. 28.5 lbs.

009-83123 **269.99**
P Personalized 009-83124 **299.99**

Catalog/Online EXCLUSIVE
C. Craftsman 123-piece 3/8-inch Drive Inch/Metric Socket Wrench Set. Includes 117 sockets: 10 6-pt. inch (1/4 thru 13/16 in.); 15 6-pt. metric (6 thru 20 mm); five 8-pt. inch (1/4 thru 1/2 in.); 10 12-pt. inch (5/16 thru 7/8 in.); 12 12-pt. metric (9 thru 19, 21 mm); nine 6-pt. inch deep (3/8 thru 7/8 in.); 11 6-pt. metric deep (9 thru 19 mm); nine 6-pt. inch mid-length (3/8 thru 7/8 in.); 11 6-pt. metric mid-length (9 thru 19 mm); 12 hex bits: six inch (5/32 thru 3/8 in.); six metric (4 thru 8, 10 mm); 11 screwdriver bits: three slotted (.030, .039, .055), four Phillips (#1, 2, 3, 4); four Torx® (T-30, T-40, T-45, T-50); two spark plug sockets (5/8, 13/16 in.). Also includes three extension bars (3, 6, 10 in.), quick-release ratchet, universal joint and 10-inch flex T-handle. Separate prices total \$524.57. Wt. 15.5 lbs.

009-34826 **199.99**

D. Craftsman 73-piece 1/4-inch Drive Inch/Metric Socket Wrench Set. 66 sockets: 11 6-pt. inch (5/32 thru 9/16 in.); 12 6-pt. metric (4, 5, 5.5, 6 thru 14 mm); 10 6-pt. inch deep (3/16 thru 9/16 in.); 11 6-pt. metric deep (4 thru 14 mm); 10 12-pt. standard (3/16 thru 9/16 in.); five inch hex bits (3/16 thru 3/8 in.); seven screwdriver bits: two slotted (5-6, 6-8) and two Phillips (#1, #2); three Torx® bits (T-15, T-20, T-25). Includes two extension bars (3, 6 in.); quick-release ratchet, universal joint, 6-inch flex T-handle, 1/4-inch flex extension and 4 1/2-inch slide bar. Separate prices total \$245.37. Wt. 4.63 lbs.

009-34827 **99.99**

E. Craftsman 79-piece 1/2-inch Drive Inch/Metric Socket Wrench Set. 14 6-pt. inch (3/8 thru 1 1/8, 1 1/4 in.); 11 6-pt. inch deep (1/2 thru 1 1/8 in.); 15 12-pt. inch (3/8 thru 1 1/8, 1 1/4 in.); 21 12-pt. metric (9 thru 28, 30 mm); 11 12-pt. metric deep (13, 14, 15, 17 thru 22, 24, 27 mm). Also three extension bars (3, 6, 10 in.); two spark plug sockets (5/8 and 13/16 in.); quick-release ratchet; MicroTorq® Torque Wrench (20 to 150 pounds). Separate prices total \$518.71. Wt. 27 lbs.

009-34824 **229.99**



3/4-INCH

B includes case



1/4-INCH

D



F

All Catalog/Online EXCLUSIVES
F. Craftsman 82-piece All 6-point Dual-Mark Socket Set. Includes inch and metric sizes in 1/4, 3/8 and 1/2-inch drives. 1/4-inch sockets include 11-inch (5/32 thru 9/16 in.) and 12 metric (4, 5, 5.5, 6 thru 14 mm). 3/8-inch sockets include 13-inch (1/4, 5/16, 3/8, 7/16, 1/2, 9/16, 5/8, 11/16, 3/4, 13/16, 7/8, 15/16, 1 in.) and 17 metric (6 thru 22 mm). 1/2-inch sockets include 15 inch (3/8, 7/16, 1/2, 9/16, 5/8, 11/16, 3/4, 13/16, 7/8, 15/16, 1, 1 1/16, 1 1/8, 1 3/16, 1 1/4 in.) and 14 metric (9 thru 22 mm). Separate prices total \$332.18. Wt. 9.95 lbs.

009-35741 **129.99**

Also Available
Craftsman 81-piece All 12-point Dual-Mark Socket Set. 1/4-inch sockets include 10 inch (3/16 thru 9/16 in.). 3/8-inch sockets include 13 inch (1/4, 5/16, 3/8, 7/16, 1/2, 9/16, 5/8, 11/16, 3/4, 13/16, 7/8, 15/16, 1 in.) and 15 metric sockets (6 thru 19, 21 mm). 1/2-inch sockets include 19 inch sockets (3/8 thru 1 1/2 in.) and 24 metric sockets (9 thru 30, 32, 36 mm). Separate prices total \$396.69. Wt. 15.1 lbs.

009-35742 **149.99**

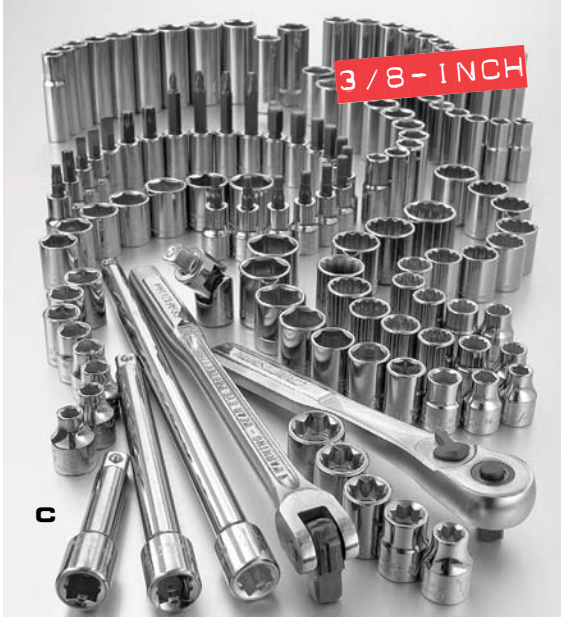

3/8-INCH

C



1/2-INCH

E



G

All Catalog/Online EXCLUSIVES
G. Craftsman 63-piece All 6-point Dual-Mark Deep Socket Set. Includes inch and metric sizes in 1/4, 3/8 and 1/2-inch drives. 1/4-inch sockets include 10 inch (3/16 thru 9/16 in.) and 11 metric (4 thru 14 mm). 3/8-inch sockets include 11 inch (3/8, 7/16, 1/2, 9/16, 5/8, 11/16, 3/4, 13/16, 7/8, 15/16, 1 in.) and 11 metric (9 thru 19 mm). 1/2-inch sockets include 11 inch (1/2 thru 1 1/8 in.) and nine metric (12 thru 19, 21 mm). Separate prices total \$384.47. Wt. 13.3 lbs.

009-35743 **179.99**

Also Available
Craftsman 62-piece All 12-point Dual-Mark Deep Socket Set. 1/4-inch sockets include 10 inch (3/16 thru 9/16 in.). 3/8-inch sockets include 11 inch (3/8, 7/16, 1/2, 9/16, 5/8, 11/16, 3/4, 13/16, 7/8, 15/16, 1 in.) and 13 metric (9 thru 22 mm). 1/2-inch sockets include 13 inch (7/16 thru 1 3/16 in.) and 15 metric (10 thru 22, 24, 27 mm). Separate prices total \$434.38. Wt. 16.8 lbs.

009-35744 **199.99**

All Catalog/Online EXCLUSIVES

H. Craftsman 299-piece Dual-Mark Socket Set... the Ultimate Set!

The ultimate socket set with every Craftsman socket size available in 1/4, 3/8 and 1/2-inch drive sizes in regular and deep lengths. See chart for set contents. Separate prices total \$1,600.44. Made in USA. Guaranteed Forever!* Wt. 51 lbs.

009-35299 479.99

Also Available

Craftsman 176-piece Dual-Mark Socket Set.

See listing below for set contents. Separate prices total \$769.44. Made in USA. Guaranteed Forever!* Wt. 13.9 lbs.

009-34032 199.99

176-piece set

1/4-in. sq. drive sockets

- 11 6-pt. inch (5/32 thru 9/16 in.)
- 12 6-pt. metric (4, 5, 5.5, 6 thru 14 mm)
- 10 12-pt. inch (3/16 thru 9/16 in.)
- 10 6-pt. deep inch (3/16 thru 9/16 in.)
- 11 6-pt. deep metric (4 thru 14 mm)

3/8-in. sq. drive sockets

- 13 6-pt. inch (1/4 thru 1 in.)
- 17 6-pt. metric (6 thru 22 mm)
- 11 12-pt. inch (1/4 thru 7/8 in.)
- 11 12-pt. metric (9 thru 19 mm)
- 7 6-pt. deep inch (3/8 thru 3/4 in.)
- 9 6-pt. deep metric (9 thru 17 mm)
- 6 12-pt. deep inch (3/8 thru 11/16 in.)
- 10 12-pt. deep metric (9 thru 18 mm)

1/2-in. sq. drive sockets

- 11 12-pt. inch (3/8 thru 1 in.)
- 13 12-pt. metric (9 thru 21 mm)
- 7 6-pt. deep inch (1/2 thru 7/8 in.)
- 7 6-pt. deep metric (13 thru 15, 17-19, 21 mm)

Check online for **SALE PRICING!**



J. OVER \$300 VALUE

J. Craftsman 49-piece 1/2-inch All 6-point Dual-Mark Socket Set.

Includes 15 inch sockets (3/8 thru 1 1/4 in.); 14 metric sockets (9 thru 22 mm); 11 inch deep sockets (1/2 thru 1 1/8 in.); and nine metric deep sockets (12 thru 19, 21 mm). Separate prices total \$334.11. Wt. 12.25 lbs.

009-35745 149.99

Also Available

Craftsman 66-piece 1/2-inch All 12-point Dual-Mark Socket Set.

Includes 19 inch sockets (3/8, 7/16, 1/2, 9/16, 19/32, 5/8, 21/32, 11/16, 3/4, 25/32, 13/16, 7/8, 15/16, 1, 1 1/16, 1 1/8, 1 3/16, 1 1/4, 1 1/2 in.); 24 metric sockets (9 thru 30, 32, 36 mm); 11 inch deep sockets (1/2 thru 1 1/8 in.); and 12 metric deep sockets (13 thru 22, 24, 27 mm). Separate prices total \$481.04. Wt. 19.9 lbs.

009-35746 199.99

EVERY 1/4, 3/8 & 1/2 INCH CRAFTSMAN SOCKET...THE ULTIMATE SET!

H. OVER \$1,600 VALUE

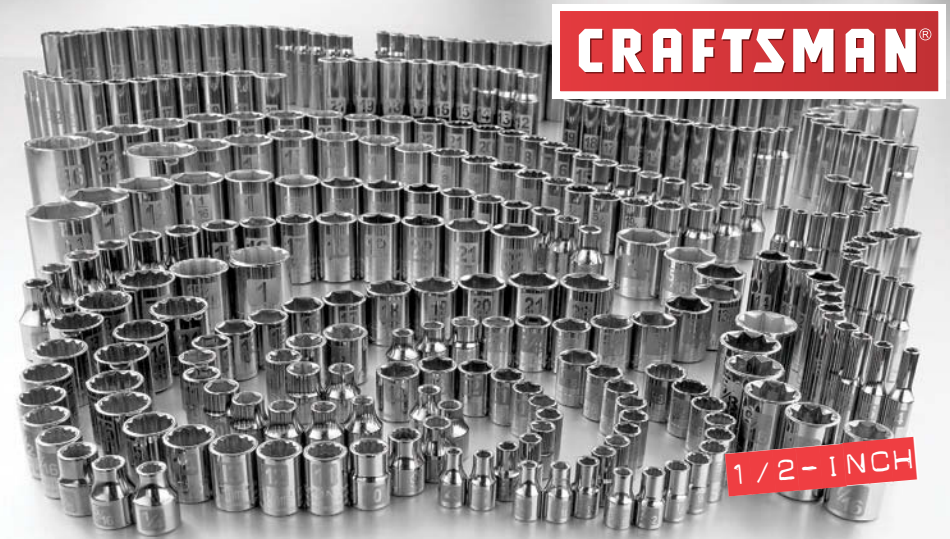

H. 299-piece

1/4-in. sq. drive sockets

- 11 6-pt. inch (5/32 thru 9/16 in.)
- 12 6-pt. metric (4, 5, 5.5 thru 14 mm)
- 10 12-pt. inch (3/16 thru 9/16 in.)
- 10 6-pt. deep inch (3/16 thru 9/16 in.)
- 11 6-pt. deep metric (4 thru 14 mm)
- 10 12-pt. deep inch (3/16 thru 9/16 in.)

3/8-in. sq. drive sockets

- 13 6-pt. inch (1/4 thru 1 in.)
- 17 6-pt. metric (6 thru 22 mm)
- 5 8-pt. inch (1/4 thru 1/2 in.)
- 13 12-pt. inch (1/4 thru 1 in.)
- 15 12-pt. metric (6 thru 19, 21 mm)
- 11 6-pt. deep inch (3/8 thru 1 in.)
- 11 6-pt. deep metric (9 thru 19 mm)
- 11 12-pt. deep inch (3/8 thru 1 in.)
- 13 12-pt. deep metric (9 thru 19, 21, 22 mm)

1/2-in. sq. drive sockets

- 15 6-pt. inch (3/8 thru 1 1/4 in.)
- 14 6-pt. metric (9 thru 22 mm)
- 6 8-pt. inch (7/16 thru 3/4 in.)
- 19 12-pt. inch (3/8 thru 1 1/2 in.)
- 24 12-pt. metric (9 thru 30, 32, 36 mm)
- 11 6-pt. deep inch (1/2 thru 1 1/8 in.)
- 9 6-pt. deep metric (12 thru 19, 21 mm)
- 13 12-pt. deep inch (7/16 thru 1 3/16 in.)
- 15 12-pt. deep metric (10 thru 22, 24, 27 mm)



K. OVER \$130 VALUE

K. Craftsman 44-piece 1/4-inch All 6-point Dual-Mark Socket Set.

Includes 11 6-point inch (5/32 thru 9/16 in.); 12 6-point metric (4, 5, 5.5 thru 14 mm); 10 6-point inch deep (3/16 thru 9/16 in.); 11 6-point metric deep (4 thru 14 mm). Separate prices total \$136.86. Wt. 2.5 lbs.

009-34855 49.99

Also Available

Craftsman 20-piece 1/4-inch All 12-point Dual-Mark Socket Set.

Includes 10 inch sockets (3/16, 7/32, 1/4, 9/32, 5/16, 11/32, 3/8, 7/16, 1/2, 9/16 in.) and 10 inch deep sockets (3/16, 7/32, 1/4, 9/32, 5/16, 11/32, 3/8, 7/16, 1/2, 9/16 in.). Separate prices total \$62.80. Wt. 1.51 lbs.

009-35749 29.99



L. OVER \$200 VALUE

All Catalog/Online EXCLUSIVES

L. Craftsman 52-piece 3/8-inch All 6-point Dual-Mark Socket Set.

Includes 13 inch sockets (1/4 thru 1 in.); 17 metric sockets (6 thru 22 mm); 11 inch deep sockets (3/8 thru 1 in.); and 11 metric deep sockets (9 thru 19 mm). Separate prices total \$235.38. Wt. 7.7 lbs.

009-35747 89.99

Also Available

Craftsman 52-piece 3/8-inch All 12-point Dual-Mark Socket Set.

Includes 13 inch sockets (1/4 thru 1 in.); 15 metric sockets (6 thru 19, 21 mm); 11 inch deep sockets (3/8 thru 1 in.); and 13 metric deep sockets (9 thru 19, 21, 22 mm). Separate prices total \$242.68. Wt. 7.7 lbs.

009-35748 89.99

*Warranted, see page 94a.

See page 43 for more information.

CRAFTSMAN®



**6-POINT
SOCKETS
FLEX
SOCKETS**

flex sockets
great for tight
spots and angles

Craftsman Flex Sockets. This access tool combines the benefits of a universal joint and a low-profile standard socket. The tilted head allows you to get into tight spots at difficult angles. Also reduces the amount of space needed to get into these areas.

Catalog/Online EXCLUSIVE

A. SAVE OVER 25% Craftsman 42-piece All Flex Socket Accessory Set. 1/4-inch 6-point sockets include eight inch (3/16 thru 9/16 in.) and ten metric (5 thru 14 mm). 3/8-inch 6-point sockets include seven inch (3/8, 7/16, 1/2, 9/16, 5/8, 11/16, 3/4 in.) and ten metric (10 thru 19 mm). 3/8-inch 12-point sockets include seven inch (3/8, 7/16, 1/2, 9/16, 5/8, 11/16, 3/4 in.). Separate prices total \$338.58. Wt. 5.5 lbs.

009-35750 249.99

Also Available

SAVE OVER 15% Craftsman 17-piece, 3/8-inch Drive Flex Socket Set. 6-point openings. Includes seven inch (3/8 thru 3/4 in.) and 10 metric (10 thru 19 mm). Separate prices total \$144.33. Guaranteed Forever!® Wt. 3.44 lbs.

009-34297 119.99

SAVE 25% Craftsman 18-piece, 1/4-inch Drive Flex Socket Set. 6-point openings. Eight standard (3/16 thru 9/16 in.) and 10 metric (5 thru 14 mm). Separate prices total \$134.82. Guaranteed Forever!® Wt. 1.06 lbs.

009-34298 99.99

Catalog/Online EXCLUSIVE

B. SAVE OVER 25% Craftsman 4-piece, 1/2-inch Drive Drag Link Socket Set. Screwdriver-type for large slotted bolts or studs. Sizes 9/16, 3/4, 15/16 and 1 3/16 in. Separate prices total \$43.96. Made in USA. Guaranteed Forever!® Wt. 0.94 lb.

009-34299 29.99

Catalog/Online EXCLUSIVE

C. Craftsman 7-pc. Dual-Mark Spark Plug Accessory Set. Includes 4 spark plugs in the 3/8-in. drive (5/8, 13/16, 3/4-in., 18 mm) and 2 1/2-in. drive sockets (5/8, 13/16-in.) that covers most household applications from the car to the lawn mower. Also includes a 3/8-in. U-joint, to give added flexibility for those tight spaces. Separate prices total \$43.55. Wt. 1.86 lbs.

009-46944 19.99

D. Craftsman 14-piece 1/4 and 3/8-inch Drive Torx® Set with New Dual-Mark External Torx® Sockets. Includes 1/4-inch drive sizes E6, E7 and E8; Torx® bit sizes T15, T20, T25. Also includes 3/8-inch drive sizes E10, E12, E14 and E16; Torx® bit sockets T30, T40, T45 and T50. Separate prices total \$101.36. Wt. 1.8 lbs.

009-34913 59.99

E. Craftsman 7-piece Tamper-proof Torx® Bit Socket Set. Set features a patented new pressure fit system to increase bit retention and reduce bit movement in holder. Made with high-strength S2 steel. Set includes sizes T15, T20, T25, T30, T40, T45 and T50. Wt. 0.6 lb.

009-42614 29.99



DRIVE BITS AND TORX® SOCKETS

**SPARK PLUG, FLEX &
BIT SOCKET OPEN STOCK
AT SEARS.COM/SHOPTOOLS**



**MID-LENGTH
HEX BIT
SOCKETS**

Catalog/Online EXCLUSIVE

F. SAVE 30% Craftsman 12-piece Inch and Metric Mid-Length Ball Hex Bit Socket Set.

New 4 5/16 in., 20-degree working angle design allows for improved access for hard-to-reach fasteners. Patented pressure fit bit retention system and durable high-strength steel insert bits ensure added value. Contains 6 inch: 5/32, 3/16, 7/32, 1/4, 5/16 and 3/8 in. and 6 metric: 4 thru 8 and 10 mm. sizes. Made in USA. Guaranteed Forever!® Separate pricing totals \$99.98. Wt. 2.1 lbs.

009-42608 69.99

G. NEW-SAVE 10 Allen Brand 31-piece Magnetic BE Hex/Torx® Key Set.

Magnetic design holds fasteners secure in tight work areas. Set includes inch sizes 0.05 thru 3/8 in.; metric sizes 1.5 thru 10 mm; Torx® sizes T10 thru T50. Wt. 2 lbs.

009-87656 49.98

Also Available

NEW Allen Brand 9-piece Magnetic Torx® Key Set. Includes sizes T10, T15, T20, T25, T27, T30, T40, T45, T50. Wt. 0.81 lb.

009-87658 19.99

Catalog/Online EXCLUSIVE

H. Craftsman 50-piece 1/4, 3/8 and 1/2-inch Drive Bit and Torx® Super Socket Set.

This master drive bit set features 1/2-inch drive hex bits in addition to 1/4 and 3/8-inch drive bits. 1/4-inch drive includes external Torx® sockets (E6, E7, E8), Torx® bit sockets (T15, T20, T25), screw bit sockets (7/32, 1/4 in. slotted and #1, #2 Phillips), standard hex sockets (3/16 thru 3/8 in.). 3/8-inch drive includes external Torx® sockets (E10, E12, E14, E16), Torx® bit sockets (T27, T30, T40, T45, T47, T50), screw bit sockets (7/32, 9/32, 3/8 in. slotted and #1, #2, #3, #4 Phillips), inch hex sockets (5/32 thru 3/8 in.), metric hex sockets (4 thru 8, 10 mm). 1/2-inch drive includes four hex bits (9/16, 5/8 in. and 14, 17 mm). Separate prices total \$343.10. Wt. 4.6 lbs.

009-35050 149.99

Also Available

SAVE OVER 40% Craftsman 23-piece, 3/8-inch Drive Bit Socket Set.

Bit sockets allow popular bits to be used with ratchets and attachments and are beneficial for access and added leverage. Includes four Phillips screwdriver bits (#1, 2, 3, 4), three slotted screwdriver bits (5-6, 8-10, 14-16), four Torx® bit sockets (T-30, T-40, T-45, T-50), six inch hex bit sockets (5/32, 13/16, 7/32, 1/4, 5/16, 3/8) and six metric hex bit sockets (4 thru 8, 10 mm). Separate prices total \$130.27. Wt. 2 lbs.

009-42723 59.99



7-pc. inch and metric sets available online

Catalog/Online EXCLUSIVE
K. SAVE \$10 Craftsman 14-piece T-through Handle Ball End Hex Key Set. The access of a ball end key, the speed of a T-handle and the torque power of an L-key. Up to a 25-degree working angle. Color-coded. Includes inch sizes 3/32, 7/64, 1/8, 5/32, 3/16, 7/32 and 1/4 inch; metric sizes 2.5, 3, 4, 5, 6, 8 and 10 mm. Separate prices total \$69.98. Wt. 3 lbs.
009-46380.....59.98

Catalog/Online EXCLUSIVE
L. Craftsman 4-piece Dual Material Fold-Up Hex Key Set. Compact and convenient, this new set features dual material grips for a comfortable, slip-resistant grip. Set includes nine-piece inch, eight-piece metric, seven-piece Torx® and seven-piece tamper-proof Torx® hex key sets. Separate prices total \$52.97. Made in USA. Guaranteed Forever!® Wt. 1.6 lbs.
009-46311.....39.99

M. Craftsman 2-piece Ball End Dual-Material Fold-Up Hex Key Set. 9-piece inch and 7-piece metric sets. Wt. 0.7 lb.
009-46009.....25.99



Catalog/Online EXCLUSIVE
J. NEW-SAVE \$15 Craftsman 11-piece T-Through Torx® Driver Set. Long shank on Torx®/tamper-proof Torx®. Short shanks for extra torque. Separate prices total \$64.98. Wt. 2 lbs.
009-87647.....49.98
Also Available
NEW Craftsman 7-piece T-Through Torx® Drivers. Set includes T10, T15, T20, T25, T27, T30, T40. Separate prices total \$61.43. Wt. 1.19 lbs.
009-46410.....34.99
NEW Craftsman 4-piece T-Through Torx® Drivers. Includes T8, T9, T45 and T50. Separate prices total \$33.56. Wt. 1.13 lb.
009-46411.....29.99

tamper-proof Torx® tips on all drivers!



MORE TO EXPLORE
 at sears.com!

Catalog/Online EXCLUSIVE
N. Allen Brand 11-piece Inch Long Length Screwdriver Handle Ball End Hex Key Set. Innovative design for greater strength, torque and access. Produces a 25-degree working angle for hard-to-reach fasteners. Color-coded handles—green for inch—for fast I.D. Set includes sizes 5/64, 3/32, 7/64, 1/8, 9/64, 5/32, 3/16, 7/32, 1/4, 5/16 and 3/8 inch. Made in USA. Wt. 2.1 lbs.
009-34908.....49.99

Also Available
Allen Brand Ball Plus 8-piece Metric Long Length Screwdriver Handle Ball End Hex Key Set. Includes sizes 2, 2.5, 3, 4, 5, 6, 8 and 10 mm. Blue handles for fast I.D. Made in USA. Wt. 1.75 lbs.
009-34909.....39.99

Catalog/Online EXCLUSIVE
P. Allen Brand Ball Plus™ 22-piece Inch and Metric Regular Length Screwdriver Handle Ball End Hex Key Set. Includes 13 inch sizes: 0.05, 1/16, 5/64, 3/32, 7/64, 1/8, 9/64, 5/32, 3/16, 7/32, 1/4, 5/16 and 3/8 in. and 9 metric sizes: 1.5, 2, 2.5, 3, 4, 5, 6, 8 and 10 mm. Made in USA. Wt. 3.2 lbs.
009-46313.....79.99

Q. NEW Allen Brand 33-piece Ball Plus Inch and Metric Regular and Inch Long Length Screwdriver Handle Ball End Hex Key Set. Designed for professionals, the innovative design delivers greater strength, torque and access. Thicker neck reduces breakage. Length and 25-degree working angle allows greater access. Regular length inch sizes include 0.05, 1/16, 5/64, 3/32, 7/64, 1/8, 9/64, 5/32, 3/16, 7/32, 1/4, 5/16, and 3/8 in., metric sizes include 1.5, 2, 2.5, 3 thru 6, 8 and 10 mm; long sizes include 5/64, 3/32, 7/64, 1/8, 9/64, 5/32, 3/16, 7/32, 1/4, 5/16, and 3/8 in. Made in USA. Wt. 5.44 lbs.
009-87759.....149.99



ALLEN

MORE ALLEN TOOLS
AT SEARS.COM/SHOPTOOLS

*Warranted, see page 94a.



A

Gripps Precision Technology

- Patented jaw design "Gripps" hex and square shapes.
- Innovative clamping chuck features parallel replaceable jaws.
- Jaws work with 3-position ratchet for use as hand driver for sockets and driver bits and as tap wrench.
- 3-position ratchet turns forward and reverse and locks neutral.
- 2-position "T"-handle locks for improved torque and control.



gripps



B NEW

Catalog/Online EXCLUSIVE

A. Schroeder® Gripps Technology 17-piece Ratcheting Tap Wrench Driver Set. Wrench grips square and hex bits with a 3/32 in. to 1/4 in. tap capacity. Includes 3-position tap wrench, T-handle, two 1/4 in. hex shank taps, one BitLoc chuck, one hex/square adapter, ten 1-in. driver bits (Phillips #1-3 and Torx® T10- T40), 2-in-1 screwdriver and case. Warranted*. Wt. 1.6 lbs.

009-34035\$59.99

Catalog/Online EXCLUSIVE

B. NEW Schroeder® 11-piece Tap Wrench and Extension Set. Combination set ideal for screw extraction, turning taps, rethreading and screw driving. Includes two 3-position T-Handle ratcheting tap wrenches (one with Gripps Jaw design for square and hex drive tools), 7-inch extension, two replacement chucks, three 3/16-inch square shank taps, and three Hi-Trac screw extractors. Tap wrench capacities 0 to 1/4 in., 1 to 6 mm and 3/16 to 5/16 in., 5 to 12 mm. Tap sizes 4, 5 and 6. Includes blow-mold case. Warranted*. Wt. 2.75 lbs.

009-87769.....\$69.99

Since 1948, Schroeder has made some of the finest automotive and precision machined industrial tools.



schroeder
Germany

ED'S PICK

Catalog/Online EXCLUSIVE

H. Grip-Tite™ 17-piece 3/8-inch Drive Super Socket Sets.

Sets include 3-inch chrome vanadium extension, quick release ratchet, and blow-mold case.

Grip-Tite™ 17-piece 3/8-inch Super Socket Set—Inch.

Standard socket sizes 3/8, 7/16 (11 mm), 1/2, 9/16, 5/8 (16 mm), 11/16, 3/4 (19 mm); deep sizes 3/8, 7/16 (11 mm), 1/2, 9/16, 5/8 (16 mm), 11/16, 3/4 (19 mm), 13/16. Wt. 4.9 lbs.

009-10324 Inch Set\$64.99

Grip-Tite™ 17-piece 3/8-inch Super Socket Set—Metric.

Standard socket sizes 10, 12 thru 15, 17, 18 mm; deep length sizes 10, 12 thru 18 mm. Wt. 4.9 lbs.

009-10325 Metric Set\$64.99



H



C

D

E

F

G

Schroeder Technology All Catalog/Online EXCLUSIVES

Description	Catalog Number	Wt., lbs.	Price
C. Gripps 10-inch Long Reach Tap Wrench Extension. Tightly grips square and hex bits. Machined steel with rust resistant coatings. Use with ratcheting, locking T-handle tap wrench. <i>Also Available</i>	009-34087	0.7	\$13.99
Square Jaw, 7-inch Long Reach Tap Wrench Extension.	009-34086	0.4	10.99
2-pc. Long Reach Tap Wrench Extension Set. Includes 10 in. and 7 in. Gripps, and square jaw design wrench extensions. Warranted*.	009-34096	1.2	21.49
D. Gripps 12-inch Long Reach Ratcheting Tap Wrench. Access hard-to-reach spaces. Grips both square and hex bits with a 1/4 to 1/2 in. tap capacity. 3-position ratcheting tap wrench features 2-position T-handle. Warranted*. <i>Also Available</i>	009-34089	1.0	21.99
Square Jaw 10-inch Long Reach Ratcheting Tap Wrench. Offers 3/32 to 1/4 in. tap capacity.	009-34088	0.6	17.99
E. Extra-Capacity 5-inch Ratcheting Tap Wrench. Extra-large opening parallel jaws. 3-position wrench with a 1/2 to 13/16-in. tap capacity. Warranted*.	009-34092	3.1	59.99
F. Gripps 5-inch T-Handle Ratcheting Tap Wrench. 3-position wrench grips square and hex bits with a 1/4-1/2 in. tap capacity. Warranted*. <i>Also Available</i>	009-34091	0.8	14.99
Square Jaw 4-inch T-Handle Ratcheting Tap Wrench. Offers 3/32 to 1/4 in. tap capacity.	009-34090	0.5	10.99
G. HI-TRAC 5-piece Fine Thread Screw Extractor Set. More effective screw removal with rolled tapered threads. Sizes 1/8-1/4, 1/4-5/16, 5/16-7/16, 7/16-9/16 and 9/16-3/4 in. Warranted*.	009-34033	0.5	14.99

GRIP-TITE™ SOCKETS – AN IRRESISTIBLE FORCE



J NEW

GRIP-TITE
SOCKET SETS

Grip-Tite™ Socket Sets—the ultimate tools for tightening good bolts and removing rounded nuts and bolts. Grip-Tite™ sockets have six cams that expand to grab onto any nut or bolt for easy removal.

Catalog/Online EXCLUSIVE

J. NEW Grip-Tite™ 31-piece 3/8-inch Super Socket Set. Set includes 3-inch extension, quick release ratchet and standard length socket sizes 3/8, 7/16 (11 mm), 1/2, 9/16, 5/8 (16 mm), 11/16, 3/4 (19 mm) and 10, 12 thru 15, 17, 18 mm; deep socket sizes 3/8, 7/16 (11 mm), 1/2, 9/16, 5/8 (16 mm), 11/16, 3/4 (19 mm), 13/16 and 10, 12 thru 15, 17, 18 mm. Wt. 6.2 lbs.

009-87690\$99.99



removes severely rounded bolts and nuts



hold or capture bolts and nuts (for those hard-to-reach places—not magnetic).



K NEW

7-piece inch (009-34546) and metric (009-34547) sets available online

Catalog/Online EXCLUSIVE

K. NEW-SAVE \$20 Craftsman 14-piece T-Handle Nut Driver Set Inch/Metric. T-handle design provides additional leverage for greater torque strength. Ergonomic non-slip grip handle is color-coded for easy identification. Set includes 3/16, 1/4, 5/16, 11/32, 3/8, 7/16, 1/2-in. and 5 thru 11 mm. Separate set prices total \$79.98. Made in USA. Wt. 3.5 lbs. **009-87648 59.98**

L. Craftsman 14-piece Nut Driver Set. Color-coded for easy identification, this set features both all the inch and metric drivers listed in the sets below. Crafted in tough alloy steel, tools measure 6 1/2 inches long. Separate prices total \$51.98. Wt. 3 lbs. **009-34070 44.99**

Personalized 009-43614 64.99



L **7-piece inch (009-4196) and metric (009-4197) sets available online**



M

Catalog/Online EXCLUSIVE

M. OVER A 140* VALUE Craftsman 21-piece Drive Tool Accessory Set. Ideal for all our 1/4, 3/8 and 1/2 in. sockets, this set of drive tools gives you the flexibility to tackle any project. Extension bars provide extra reach for tight spaces, adapters allow you to use different drive size sockets with ratchets and U-joints are perfect for fasteners in a tight space or at an angle. Set includes 13 extension bars in three drive sizes: 1/4-inch (1 1/2, 3, 6 and 14 in.), 3/8-inch (1/2, 3, 6, 10 and 20 in.), 1/2-inch (2, 3, 6 and 10 in.); 5 adapters: 1/4-inch (3/8 in.), 3/8-inch (1/4 and 1/2 in.), 1/2-inch (3/8 and 3/4 in.); 3 universal joints (1/4, 3/8 and 1/2 in.). Made in USA. Guaranteed Forever!® Separate prices total \$146.29. Wt. 6.88 lbs. **009-42283 69.99**



N

Catalog/Online EXCLUSIVE

N. Craftsman 3/8-inch 4-piece Thumbwheel Ratchet Set. Get optimum access to tight spaces with this compact set. Features full polish to resist corrosion. Includes 3/8-inch thumbwheel ratchet with 1 1/2, 3 and 6-inch wobble extension bars. Wt. 1 lb. **009-34905 29.99**



P

P. Craftsman 10-piece 1/4, 3/8 and 1/2-inch Wobble Extension Set. Add accessibility to your ratchet set with this expanded wobble set. 1/4-inch drive includes 1 1/2, 3 and 6-inch extensions; 3/8-inch drive includes 1 1/2, 3, 6 and 10-inch extensions; 1/2-inch drive includes 2, 3 and 6-inch extensions. Separate prices total \$88.90. Wt. 2.5 lbs. **009-44290 69.99**



Q

Catalog/Online EXCLUSIVE
Q. Craftsman 8-piece 3/8-inch Drive Accessory Set. Four extension bars (1 1/2, 3, 6, 10 in.), 10-inch flex T-handle, 16-inch speeder bar, two adapters (1/4, 1/2 in.). Made in USA. Guaranteed Forever!® Separate prices total \$63.22. Wt. 4.9 lbs. **009-34392 49.99**

Craftsman Professional Next Generation Full Polish Thin Profile Ratchets.

Our thinnest profile, fine tooth ratcheting action allows efficiency in small, cramped areas with six degrees of swing. Quick-release button, reversing lever, comfort grip and full polish, ergonomically designed handle. Made in USA.

Catalog/Online EXCLUSIVE

R. SAVE OVER 15* Craftsman Professional Next Generation Full Polish Thin Profile 3-piece Ratchet Set.

Set includes 1/4, 3/8 and 1/2-inch drives. Separate prices total \$97.97. Wt. 2.75 lbs. **009-33442 79.99**

Personalized 009-42055 99.99

Also Available

1/4-in Drive Thin Profile Ratchet. Ratchet is 5 3/8 inches. Wt. 0.44 lb. **009-44994 24.99**

3/8-in. Drive Thin Profile Ratchet. Ratchet is 7 11/16 inches. Wt. 0.75 lb. **009-44995 32.99**

1/2-in. Thin Profile Ratchet. Ratchet is 1/8 inches. Wt. 1.44 lbs. **009-44996 39.99**



R

Craftsman Professional Quick-Release Ratchets.

Rust- and corrosion-resistant. Strong gear/pawl mechanism is designed to withstand up to 50 percent more torque than ANSI minimum standards. Quick-release button for easy one-hand socket ejection. One-piece ratcheting plate keeps out dirt. Guaranteed Forever!®

S thru W. Craftsman Professional Full Polish Ratchets. Longer handles for greater torque and leverage than traditional ratchets. Teardrop shaped with reversing lever. 36 teeth equates to 10-degree ratcheting arc. Easy-to-clean finish.

S. Standard Teardrop Quick-Release Ratchet. Ergonomic handle provides greater comfort over extended periods of use. **1/4-inch Drive.** 5 1/2 inches long. Wt. 0.31 lb. **009-44812 22.99**

3/8-inch Drive. 7 11/16 inches long. Wt. 0.69 lb. **009-44813 27.99**

1/2-inch Drive. 10 3/8 inches long. Wt. 1.44 lbs. **009-44814 38.99**

T. Extra-Long Teardrop Quick-Release Ratchet. Longer 11-inch handle provides greater leverage than standard ratchets. 3/8-inch drive. Raised lip under reversing lever prevents accidental lever reversal. Wt. 0.84 lb. **009-44833 32.99**

U. Stubby Quick-Release Ratchet. Just 5 1/2 inches long with a short flex handle for easy access to tight areas. 3/8-inch drive. Wt. 0.5 lb. **009-44834 24.99**

V. Ergo Flex Head Quick-Release Ratchet. 12-inch long ratchet has pivoting 0 to 90-degree flex head for easier access to hard-to-reach fasteners. Ergonomic handle for added comfort during prolonged use. 3/8-inch drive. Wt. 1.34 lbs. **009-44836 32.99**

W. 22-degree Offset Handle Quick-Release Ratchet. 11 1/8-inch ratchet features a pivoting 0 to 90-degree flex head and offset handle for easier access in tight spaces. 3/8-inch drive. Wt. 1.34 lbs. **009-44835 32.99**

009-44835 32.99

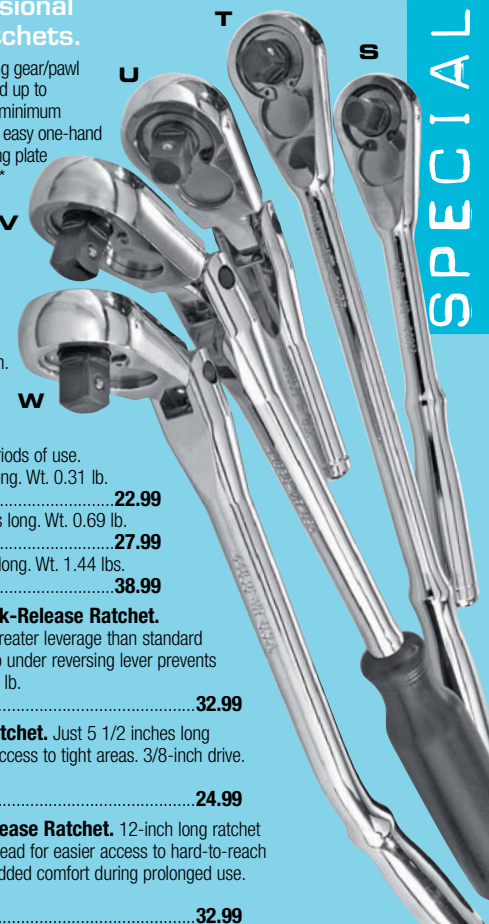

T

S

U

V

W

NUT DRIVER, DRIVE TOOL & RATCHET OPEN STOCK AT SEARS.COM/SHOPTOOLS

SPECIALTY HAND TOOLS

*Warranted, see page 94a.

P See page 43 for more information.



A. NEW SK® 48-piece 1/4-inch Drive 6-Point Inch and Metric Superset. Inch sizes include 3/16, 7/32, 9/32, 1/4, 5/16, 11/32, 3/8, 7/16, 1/2, 9/16 in. standard and 1/4, 9/32, 5/16, 11/32, 3/8, 7/16, 1/2, 9/16 in. deep. Metric sizes include 4, 5, 5.5, 6 thru 15 mm standard and 6 thru 15 mm deep. Set also includes 4 1/2-inch pro ratchet, thumbwheel ratchet, 2 and 6-inch extensions, U-joint, 1/4F x 3/8M and 3/8F x 1/4M in. adapters. Wt. 4.15 lbs.
009-90167 144.99

Catalog/Online EXCLUSIVE

B. NEW SK® 35-piece Torx® Bit Socket and 33-piece Bit Socket Super Set. Packed with a wide range of Torx®, Tamper-Proof and E-Torx® bit sockets, this set features the pressure fit system to ensure bit retention and less lateral bit movement in holder. Crafted in S2 steel. Set contains T8, T10, T15, T20, T25, T27, T30, T40, T45, T50, T55, T60 Torx®; T7, T8, T10, T15, T20, T25, T27, T30, T40, T45, T50, T55 Tamper-Proof Torx®; and E4 thru E8, E10, E12, E14, E16, E18 E-Torx® sockets. set contains 1/8, 5/32, 3/16, 7/32, 1/4, 5/16, 3/8-in. sockets; 2, 2.5, 3 thru 8, and 10 mm hex bit sockets, #1, #2, #3 Phillips bit sockets, #2 Pozidrive socket, #4, #5, #6 slotted sockets and T10, T15, T20, T25, T27, T30, T40, T45, T50, T55 Torx® bit sockets. Wt. 8.2 lbs.
009-79561 299.99

Catalog/Online EXCLUSIVE

C. NEW SK® 49-piece 3/8-inch Drive 6-point Inch and Metric Superset. This comprehensive set includes a 7 1/2 in. pro ratchet, thumbwheel ratchet, 3 in. and 6 in. extensions, and universal joint. 10 inch sockets (1/4 thru 7/8-in.) and 9 inch deep sockets (3/8 thru 7/8-in.). 13 metric sockets (6 thru 8 and 10 thru 19 mm) and 10 metric deep sockets (10 thru 19 mm). Wt. 8.75 lbs.
009-90168 169.99



MORE TO EXPLORE
 at sears.com!



Catalog/Online EXCLUSIVE
D. SK® 12-pc. Torx® Plus Bit Socket Set with Rail. High-polish SuperKrome finish for maximum corrosion resistance. New press fit holder provides secure hold on bits while in use. Bits are manufactured using high-strength S2 steel. Sizes include T8, T10, T15, T20, T25, T27, T30, T40, T45, T50, T55, T60. Comes with metal rail. Wt. 0.9 lb.
009-34217 129.99

Also Available
SK® 9-pc. Torx® Plus Bit Socket Set. Sizes include T10, T15, T20, T25, T27, T30, T40, T45, T50. Comes with metal rail. Wt. 0.8 lb.
009-99504 99.99

Catalog/Online EXCLUSIVE
E. SK® 9-pc. Tamper-Proof Hex Bit Socket Set. High-polish SuperKrome finish for maximum corrosion resistance. New press fit holder provides secure hold on bits while in use. Made using high strength S2 steel. Sizes include 5/64, 3/32, 7/64, 1/8, 9/64, 5/32, 3/16, 7/32, 1/4 in. Comes with socket rail. Wt. 0.8 lb.
009-99493 79.99

Catalog/Online EXCLUSIVE
F. SK® 10-piece Long Torx® Bit Socket Set. 4 and 5-inch long bit sockets provide access to hard-to-reach Torx® fasteners. Packaged on a metal clip rail. Includes T-8, T-10, T-15, T-20, T-25, T-27, T-30, T-40, T-45 and T-50 long Torx® bit sockets. Made in USA. Warranted*. Wt. 1.3 lbs.
009-34717 109.99

*Warranted, see page 94a.

Catalog/Online EXCLUSIVE
G. SK® 7-piece 1/2-inch Drive Hex Bit Socket Sets. New patented pressure fit bit holder improves bit retention and reduces lateral bit movement. Crafted in high-strength S2 steel. Includes sizes 5/16, 3/8, 7/16, 1/2, 9/16, 5/8 and 3/4 in. Made in the USA. Wt. 2.04 lbs.
009-43342 104.99

Also Available
SK® 1/2-inch Drive Metric Hex Bit Socket Set. Includes sizes 6, 8, 10, 12, 14, 17 and 19 mm. Wt. 2.32 lbs.
009-43343 104.99

Catalog/Online EXCLUSIVE
H. SK® Ball Hex Bit Socket Sets. 25-degree working angle for use on hard-to-reach fasteners. High-strength S2 steel construction features through-hole design. Made in USA. Warranted*.
6-piece Inch Set. Includes sizes 5/32, 3/16, 7/32, 1/4, 5/16 and 3/8 in. Wt. 0.5 lb.
009-30508 44.99
6-piece Metric Set. Includes sizes 3, 4, 5, 6, 8 and 10 mm. Wt. 0.5 lb.
009-30509 44.99

Catalog/Online EXCLUSIVE
J. SK® 4-piece Triple Square Bit Socket Set. For use on 12-point applications on foreign and domestic vehicles. Long bit design provides access to hard-to-reach areas. Crafted in high-strength S2 steel. Includes sizes 6, 8, 10 and 12 mm. Made in the USA. Wt. 0.99 lb.
009-99480 54.99

Catalog/Online EXCLUSIVE
K. SK® 8-piece Metric Long Ball Hex Bit Set. High-strength S2 steel bits have SuperKrome finish on bit holders for corrosion resistance. Ball ends provide access in tight areas. Includes sizes 3 thru 10 mm. Packaged on metal clip rail. Made in USA. Warranted*. Wt. 1.5 lbs.
009-44355 99.99

Also Available
7-piece Inch Long Ball Hex Bit Set. Includes sizes 1/8, 5/32, 3/16, 7/32, 1/4, 5/16 and 3/8 inches. Wt. 0.75 lb.
009-44354 69.99



654-PIECE—MASTER SET



L. NEW +FREE SHIPPING WITH MASTER SET AND/OR MASTER SET WITH STORAGE COMBO

Catalog/Online EXCLUSIVE

L. NEW SK® 654-piece Master Set. A comprehensive set for an individual who wants to get started with a full assortment of mechanic's tools. See chart for contents. Limited lifetime warranty. Shipping included within the continental U.S.† Wt. 187 lbs.
009-83252 **6,499.99**

Catalog/Online EXCLUSIVE

M. NEW SK® Limited Edition Series 41" 19-Drawer Combo. A professional grade chest and cabinet designed with solid construction, a 1,200 lb. load capacity with over 26,000 cu. in. of storage space and a wide range of features, including ball-bearing drawer slides. Backed with a 7-year warranty means that you can load your cabinet with your SK tools in confidence. Wt. 235 lbs.
009-83253 **2,499.99**

Catalog/Online EXCLUSIVE

SAVE \$2,500 when you buy the complete combo "L" and "M" SK® 654-piece Master Mechanic's Set and Limited Edition 41" 19-Drawer Combo. Provides over 26,000 cu. in. of storage space and 1,200 lb. load capacity. Separate prices total \$8,999.98. Shipping included within the continental U.S.† Wt. 450 lbs.
009-83254 **5,999.99**



MECHANIC'S TOOLS

L. 654-piece

- | 1/4-in. sq. drive sockets | wrenches & specialty tools |
|-----------------------------------------------------------------------------------------------------------------------------------------------------------------------------|-----------------------------------------------------------------------------------------------------------------------------------------------------------|
| 41 6-pt. inch (3/16 thru 9/16-in.), 6-pt. inch deep (1/4 thru 9/16), 6-pt. metric (4 thru 15 mm), 6-pt. metric deep (6 thru 15mm) | 29 Combination wrenches inch (1/4 thru 1-in. Combination wrenches metric (6 thru 22 mm) |
| 19 6-pt. flex inch (3/16 thru 9/16 in.) 6-pt. flex metric (5 thru 15 mm) | 21 Long pattern inch combination wrenches (1/4 thru 3/4-in.) Long pattern metric combination wrenches (8 thru 19 mm) |
| 3 Ratchets (6.3-in. flex head, 1.5-in. thumbwheel, 4.5-in. Pro) | 21 Short pattern inch combination wrenches (3/8 thru 1-in.) Short pattern metric combination wrenches (10 thru 19 mm) |
| 8 Extensions (2 thru 14-in.) | 11 Flare nut wrenches-inch (1/4 x 5/16-in., 3/8 x 7/16-in., 1/2 x 9/16-in., 5/8 x 11/16-in., 3/4 x 7/8-in.) |
| 1 Universal Joint | Flare nut wrenches-metric (9 x 11 mm, 10 x 12 mm, 13 x 14 mm, 15 x 17 mm, 16 x 18 mm, 19 x 21 mm) |
| 5 adapters (1/4 F to 3/8-in. M; 3/8 to 1/4-in. M; 3/8 to 1/2-in. M; 1/2 F to 3/8-in. M; 1/2 to 3/4-in. M) | 21 Crowfoot Wrenches-inch (3/8 thru 1-in.) Crowfoot Wrenches-metric (9 thru 19 mm) |
| 3/8-in. sq. drive sockets | |
| 44 6-pt. inch (1/4 thru 7/8-in.), 6-pt. inch deep (3/8 thru 7/8-in.) | 1 Adjustable Wrench (12-in.) |
| 6-pt. metric (6 thru 19 mm), 6-pt. metric deep (10 thru 19 mm) | 23 T-handle wrenches-inch (5/64 thru 3/8-in.) |
| 17 6-pt. flex inch (3/8 thru 3/4-in.) 6-pt. flex metric (10 thru 19 mm) | T-handle wrenches-metric (2 thru 10 mm) |
| 11 Plug Sockets (3/16 thru 3/8 in. M) (1/4 thru 3/8-in. F) | T-handle wrenches-Torx® (T10 thru T30) |
| 3 Ratchets (10.9-in. flex head, 5-in. stubby flex head, 7.5-in. Pro) | 28 Hex Key wrenches – inch short (1/20 thru 1/4-in.) long (5/16 thru 3/8-in.) |
| 10 Extensions (1.5 thru 12-in., 1.5 thru 12-in. wobble) | Hex Key wrenches – metric (1.3 thru 10 mm) |
| 2 Universal Joint (1.94, 1.92-in.) | 32 Torx®, Tamper-proof, and E-Torx® (T8-T60, T10-T50, and E4-E18) |
| 40 6-pt. inch impact sockets (5/16 thru 3/4-in.), (5/16 thru 3/4-in. deep) | 29 Hex bit sockets – inch (5/32 thru 5/8-in., 5/32 thru 3/8-in.) Hex bit sockets – metric (4 thru 17 mm, 4 thru 10 mm) |
| 6-pt. metric impact sockets (8 thru 19 mm), (8 thru 19 mm deep) | 10 Screwdrivers: slotted (1/4 x 1.52, 1/4 x 3.96, 5/16 x 5.87, 3/8 x 8, 3/8 x 9.90, 7/16 x 11.80) & Phillips (#0 x 2.52, #1 x 3.00, #2 x 1.76, #2 x 4.00) |
| 18 6-pt. inch swivel impact sockets (5/16 thru 3/4-in.) 6-pt. metric swivel impact sockets (10 thru 19 mm) | 6 Torx® drivers (T10 thru T30) |
| 1/2-in. sq. drive sockets | |
| 34 6-pt. metric (10 thru 28 mm) 6-pt. metric deep (10 thru 24 mm) | 6 Micro screwdrivers-Phillips (#000, #00, #0) |
| 30 12-pt. inch (3/8 thru 1 1/4-in.) 12-pt. inch deep (3/8 thru 1 1/4-in.) | 6 Micro screwdrivers-slotted (2, 2.5, 3 mm) |
| 3 Ratchets (10.3-in., 15-in. Pro, 17.6-in. flex head) | 7 Hex Nut Drivers (1/4 x 3/4-in. thru 7/16 x 4 mm, 7 mm x 3 1/4-in. thru 10 mm x 4-in.) |
| 1 Drive handle (15-in. flex head) | 6 Chain sockets (1/4, 3/8, 1/2, 5/8-in.) |
| 3 Extensions (5, 10, 20-in.) | 6 Pliers (slip joint, 7, 10, 16-in. tongue and groove, chain nose w/cutter, heavy-duty angled diagonal cutter) |
| 62 6-pt. inch impact sockets (3/8 thru 1 1/4-in.) inch deep (3/8 thru 1 1/4-in.) 6-pt. metric impact sockets (8 thru 24 mm) 6-pt. metric deep impact sockets (10 thru 24mm) | 6 Retaining ring pliers (.038, .047, .070-in. straight & 90 degree tips) |
| 2 Impact extensions w/ball retainer (3.5-in.) | 2 Hammers 1-soft face, 1 ballpeen) |
| 2 Flip impact sockets inch (3/4 X 13/16-in.) metric (19 X 21 mm) | 17 Punches (4 pin, 2 starter, 1 line up, 1 center, 9 roll pins) |
| 1 Impact universal joint (2.61-in.) | 4 Chisels (1/4, 3/8, 1/2, 5/8-in.) |
| | 4 Pry bars (12, 17, 25, 31-in.) |
| | 6 Files (6-in. mill bastard, 7-in. slim taper, 8-in. round bastard, 8-in. flat bastard, 8-in. square bastard, 8-in. half round bastard) |
| | 4 Gasket scrapers (9.5-in. carbon, 8-in. offset, 7.18 x 5/8-in. gasket, 7-in. stubby) |

UNIVERSAL SPLINE

- more versatile, more productive
- like having six tools in one

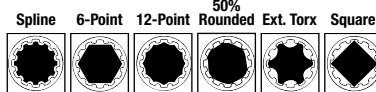

Catalog/Online EXCLUSIVE

N. SK® 45-piece Universal Spline 3/8-inch Drive Socket Set. Patented design works on spline, 6-point, 12-point, female Torx®, square and even 50% rounded fasteners! High-polish SuperKrome plating for long life. Sizes include inch 5/16, 3/8, 7/16, 1/2, 9/16, 5/8, 11/16, 3/4, 13/16, 7/8 in.; deep inch 3/8, 7/16, 1/2, 9/16, 5/8, 11/16, 3/4, 13/16, 7/8 in.; metric 7 thru 19 mm; deep metric 10 thru 19 mm; fine-tooth palm control ratchet and 3 and 6-inch wobble extensions. Made in USA. Wt. 8 lbs.
009-34216 **149.99**

Catalog/Online EXCLUSIVE

P. SK® 5-piece Metric Stubby Flexible Double-Box Universal Spline G-Pro Wrenches. Compact design for greater access in small spaces. Features a universal spline ratcheting box end and flex head with a wide 180° flex range. Sizes include 8 x 10, 12 x 14, 13 x 15, 16 x 18 and 17 x 19 mm. Wt. 1.9 lbs.
009-34212 **124.99**

Also Available

SK® G-Pro 4-piece Inch Stubby Flexible Double-Box Universal Spline G-Pro Wrenches. Sizes include 5/16 x 3/8, 7/16 x 1/2, 9/16 x 5/8 and 11/16 x 3/4 in. Wt. 1.26 lbs.
009-34213 **99.99**

Catalog/Online EXCLUSIVE

Q. NEW SK® Micrometer Torque Wrenches. Easy-read scale lets you view settings on the handle and set torque by simply turning the handle. Accurate to ± 3% from 20 to 100% of scale. Includes calibration certificate.

3/8-in. Square Drive Micrometer Torque Wrench. 100 ft.-lbs. Wt. 2 lbs.
009-83255 **139.99**

1/2-in. Square Drive Micrometer Torque Wrench. 250 ft.-lbs. Wt. 2.5 lbs.
009-83256 **159.99**



†Within the continental U.S.

ALUMINUM JACKS FEATURE HEAVY-DUTY CONSTRUCTION



A. Craftsman Professional 3-Ton Aluminum Floor Jack. Features a 6,000-pound capacity and a lifting range of 3 7/8 to 18 1/2 in. Constructed of lightweight aluminum for easy jack positioning and maneuverability. "Speed-Lift" design requires only two pumps to bring the saddle to the chassis. Meets all ANSI/ASME standards. Features side and rear carry handles for easy positioning, and a quick-release main handle. Wt. 59.38 lbs.

009-50244 **\$329.99**

Also Available
Craftsman Professional 3-Ton Jack Stands. Lift range of 11 1/2 to 17 inches. Set of 2. Wt. 21.8 lbs.

009-50159 **Set 24.99**

Craftsman Professional 12-Ton Jack Stands. Lift range of 17 1/2 to 27 1/4 inches. Set of 2. Wt. 66.5 lbs.

009-50340 **Set 119.99**

B. Craftsman Aluminum 2-Ton Capacity Floor Jack. This aluminum jack is lightweight, yet incredibly powerful. Features three-piece welded aluminum arm for extra strength, ear and side frame handles for easy lifting and carrying. Lifting range is 3 3/4 to 18 1/2 inches. Meets ANSI/ASME safety standards. Wt. 42.7 lbs.

009-50239 **219.99**

C. Craftsman Professional Aluminum 1,500-pound Motorcycle Jack. Lightweight aluminum construction with a new 3 1/2-inch low profile makes this unit ideal for lifting, cleaning and moving motorcycles and ATVs. Locking mechanism secures vehicle at four desired levels. Rubber covered handle prevents scratching on lifted vehicle. Tie-down straps secure vehicle to jack. Adapter plates increase lifting range from 3 1/2 to 19 inches. Warranted*. Wt. 51.4 lbs.

009-50191 **199.99**



4,000 lb. capacity aluminum jack

lightweight, aluminum motorcycle /ATV jack

holds up to a 3/4-ton motorcycle

D. Craftsman Professional Hydraulic Bottle Jacks

Heat-treated saddle. Wide stance, one-piece base with safety valve for stable, controlled lowering.

Description	Lift Range (in.)	Catalog Number	Wt., lbs.	Price
6-Ton Side Pump	8 5/8 to 16 13/16	009-50282	12.05	\$24.99
12-Ton Side Pump	9 7/16 to 18 5/8	009-50284	18.37	39.99
20-Ton Side Pump	9 1/2 to 18 11/16	009-50285	28.7	69.99
12-Ton Shorty	6 to 10 3/4	009-50320	14.3	64.99
20-Ton Shorty	6 1/2 to 11 1/4	009-50321	22.66	84.99
12-Ton Air	9 1/2 to 18 5/8	009-50332	26.95	199.99
20-Ton Air	9 1/2 to 18 1/4	009-50333	36.4	279.99



E. Craftsman 1,500-pound Motorcycle/ATV Jack. Handles snowmobiles, lawn tractors, watercraft, motorcycles and ATVs. Features swivel locking casters, rectangular tie-down loops and extended T-bar handles for more maneuverability. Lifting range from 5 1/8 to 17 inches. Three-position lock at 11 3/4, 14 1/4 and 16 1/2 inches. Warranted*. Wt. 90.6 lbs.

009-50190 **119.99**



Catalog/Online EXCLUSIVE

F. Craftsman 7-piece Lug Nut Set. Durable laser-etched sockets for a firm connection and easy identification. 1/2-inch deep sockets (3/4, 13/16, 7/8, 15/16 in. and 17 and 9 mm) with a 6-inch extension bar to access various wheel mounts. Separate prices total \$64.53. Made in USA. Guaranteed Forever!*

Wt. 3 lbs.
009-42124 **39.99**

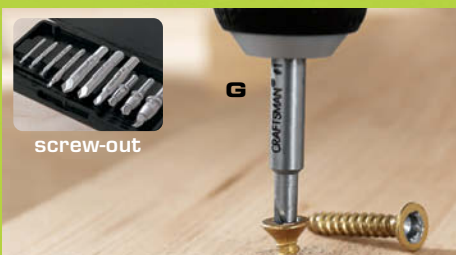

G. Craftsman 10-piece Drill-Out, Micro Standard Drill-Out and Screw-Out Set with Case. Drill-Out removes most common fasteners with 3/8-inch reversing drill without damaging surrounding material. Includes 5/16, 3/8 and 1/2-inch Drill-Out bits; #5, #8, #10 and 1/4-inch Micro Drill-Out bits and #3 Screw-Out. Made in USA. Wt. 0.35 lb.

009-52158 **69.99**



H. Craftsman 7-piece Drill-Out Power Extractor Set. Works with your power drill. Unique flexing action and shallow serrations make extraction more successful. Self-centering tip has a bell-shaped drill head that will not walk when drilling into broken bolts. Set includes 1/8 in. or #5-6 and 3 mm, #8 and 4 mm, #10-12 and 5 mm, 1/4 in. and 6 mm, 5/16 in. and 8 mm, 3/8 in. and 10 mm, 1/2 in. and 12 mm. Wt. 0.3 lb.

009-53153 **59.99**



J. Craftsman 14-piece Bolt-Out Set PLUS Case. All removers have external hex and internal square drive to remove stripped or rusted nuts and bolts. Includes punch. Hex sizes 1/4, 5/16, 3/8, 7/16, 1/2, 9/16, 5/8, 11/16 and 3/4 in. and metric 6, 8 and 9 thru 19 mm. Wt. 2 lbs.

009-52062 **49.99**

ADDITIONAL DRILL-OUT, BOLT-OUT, SCREW-OUT SETS AVAILABLE AT SEARS.COM/SHOPTOOLS

CREEPERS & SEATS

K. Craftsman Creeper/Seat. This 40-inch creeper quickly converts to a seat with a quick-releasing clip. The headrest provides excellent back support in the seat position with a 7 x 10 in. back pad. When in the seated position, all five 2 1/2-inch oil-resistant rollers stay on the ground for superior stability. Fully padded with heavy-duty vinyl. Frame is powdercoated to help prevent rusting. Measures 40L x 17W x 6 1/2D in. Wt. 26 lbs.
009-51159 89.99



combo creeper/seat



L. Racatac Kneeling/Sitting Creeper. Ideal for auto work, flooring, plumbing, painting and more, the Racatac™ is designed for complete ergonomic comfort. Maintain a stable working position with thick foam kneepads and an adjustable websping seat. Use it in a kneeling position, or on a single knee. Features tray for tools. Strong aluminum frame set on five 3-inch ball-bearing casters. Seat and post detaches for convenient storage. Supports up to 300 lbs. Wt. 8.5 lbs.
009-51162 179.99



RACATAC™ PRODUCTS INC.

quick hydraulic fold-up converts to a seat on wheels



M. Craftsman Adjustable-Height Mechanic's Seat. Features hand lever for adjusting seat from 16 1/2 to 21 1/2 inches high. Seat rotates 360 degrees. Measures 18 1/4 W x 16 1/2D in. Made in USA. Wt. 24 lbs.
009-51118 139.99



M

N. Craftsman Professional Roller Creeper. Four 6-inch rollers make this the king of all creepers. Designed for easy rolling, even on gravel and grass. 40-inch metal frame creeper has skewed rails, heavy-duty 1-inch steel tubing. Powdercoated to help resist rusting. Supports up to 1,000 pounds. Measures 40L x 20W x 5H in. Made in USA. Wt. 26 lbs.
009-51168 179.99

Catalog/Online EXCLUSIVE

T. Wheelfloat® Wheel Dolly. Reduce the strain associated with lifting and positioning a heavy wheel and tire on to a balancer, tire changer or vehicle. Unlike most ergonomic tools, the Wheelfloat® will not only reduce strain during the fastening process, but may also reduce cycle time by allowing accurate positioning of the wheel first time, every time. The patented gas traction "X" frame stores downward force exerted by the operator and converts it to an upward lifting force. When the gas spring is released using one of the two release handles, the stored energy in the wheel dolly takes the strain of lifting away from the operator. Wheelfloat® is the only wheel dolly specifically designed for the light truck and passenger vehicle market segment, and is designed to accommodate most single and dual wheels up to 130 pounds in weight and 36 inches in diameter. Imported. One-year limited warranty.* Wt. 45 lbs.
009-47324 599.99



wheel dolly



*Warranted, see page 94a.

adjustable at both ends



Q

Catalog/Online EXCLUSIVE

Q. Craftsman Professional 2Up 44-inch Long Creeper. Adjusts on both ends to give the user comfort while using it as a creeper or a low-to-the-ground seat. Back pad adjusts to five positions (up to 65 degrees), 3/4-inch tubular steel frame supports up to 1,000 pounds. Six 2 1/2-inch oil-resistant rollers swivel 360 degrees. Fully padded with leatherette, including raised headrest for comfort and durability. Measures 44 1/4L x 17W x 5 3/4D in. Made in USA. Warranted*. Wt. 28 lbs.
009-51148 159.99

R. The Bone Rough Rider™ Creeper. Designed to go where no other creeper can, the Rough Rider is perfect for outdoors, on firm gravel and off-pavement work. Use with trucks, farm equipment, motorhomes and other large vehicles. Features 5 1/4-inch diameter x 1 5/16-inch wide wheels and extra-wide flotation type tread to help the creeper move over soft surfaces. 2 1/2-inch ball-bearing swivels and 2 7/8-inch clearance for a smooth roll over uneven terrain. Heavy-gauge steel caster frames and ribbed body to support heavier users. Measures 47L x 25 1/2W in. 100% made in USA. Warranted*. Wt. 24 lbs.
009-51110 149.99

S. The Bone™ Creeper. Low-riding design equipped with large, easy-roll 5 1/8-inch diameter wheels gets you where you need to be. Unique wheel placement in outboard pod allows larger easy-rolling wheels while maintaining extra-low, 1 3/4-inch ground clearance. State-of-the-art plastic co-polymer design comfortably cradles body with no sharp corners or cracks that pinch. Solvent-resistant and easy to clean. Oil-resistant tires. Measures 47L x 25 1/2W in. 100% made in USA. Warranted*. Wt. 22 lbs.
009-51000 119.99

Catalog/Online EXCLUSIVE

P. Craftsman Professional Hydraulic Combination Creeper/Seat. With one hand and the help of a hydraulic cylinder, this 40-inch long creeper quickly converts to a seat. Keeps you comfortable during long repair jobs. Fully padded seat features a 9 x 11 in. back pad that provides excellent support. When in seat position, all six 2 1/2-inch, oil-resistant wheels stay on the ground for superior stability. Seat height is 17 inches. 3/4-inch tubular steel frame has a rust-resistant powdercoat finish. Measures 40L x 17W x 6 1/2D in. Made in USA. Warranted*. Wt. 28 lbs.
009-51143 179.99

THE BONE™ "ROUGH RIDER™"



R

5 inch wheels

S

THE BONE®

AUTOMOTIVE SPECIALTY

A NEW

TruLink Technology

Every Actron scan tool and code reader incorporates CAN and the patented TruLink Technology which guarantees links to all compliant vehicles ensuring fast and accurate diagnostic information – the key to effective repair.

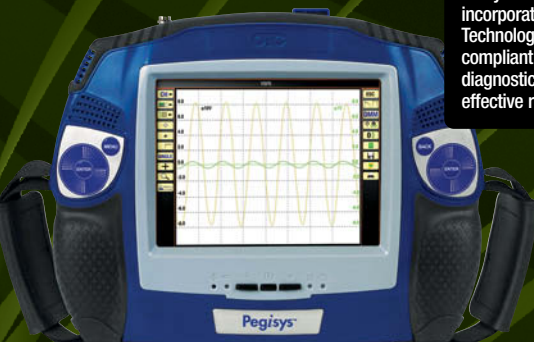

SD optional software upgrades for TechScan 7000 for expanded vehicle coverage (cables included where applicable)

- 009-87798 89-95 Toyota/Lexus SD Card109.99
- 009-87799 91-95 Honda/Acura SD Card99.99
- 009-87888 87-95 Nissan SD Card99.99
- 009-87889 ABS OBDII 96-newer89.99

B NEW

C NEW



Catalog/Online EXCLUSIVE
A. NEW OTC Pegisys™ Kit 3825. The most advanced hand-held diagnostic tool available frees you to work more productively. With AirBridge™ wireless technology, you can get wireless readings from a vehicle even when it's on a lift, and instant internet access to real time web-enabled assets. OTC Direct-Hit Technician™ provides over 27 years (1980 – 2007) of coverage for 44 makes from over 25 manufacturers. Includes Scan Pathfinder™, Scope InfoTech™ diagnostics, Repair-Trac™ Tech Tips, Automated System Test™, large screen touch control, SpeedScroll™ Thumb pads, built-in 2-channel scope, audio and video capability and more! Wt. 42.15 lbs. 009-839955,499.99

Catalog/Online EXCLUSIVE
B. NEW OTC® Genisys® Kit 3862. EVO™ System 3.0 featuring Code-Assist™ with OBD II Smart Cable, Automated System Test™, USA 2008 Domestic software with Pathfinder, Repair-Trac™, Fast fixes™, USA 2008 Asian software, USA 2008 ABS/Air Bag software and vehicle-specific cables, InfoTech 2006 software, manuals, adapters, domestic OBD I vehicle cables (for GM, Ford, Chrysler, Jeep, Saturn), Smart Cards, and carrying case. Wt. 21.3 lbs. 009-839962,399.99

Catalog/Online EXCLUSIVE
C. NEW Actron AutoXray EZ-TechScan 7000. Unmatched coverage on all 1996 and newer vehicles - including enhanced code coverage on all 1996 and newer vehicles and enhanced datastream data on 1982-2006 GM, Ford and Chrysler vehicles. Internet updateable. X-ray tool has bidirectional capabilities. Offers acronym library and customizable views. Screen data in English, Spanish or French. Includes SD card slot (allows memory expansion), on-screen graphing, 128 x 128 pixel backlit screen, USB port and cables for pre-1996 domestic vehicles. Wt. 8.25 lbs. 009-87797499.99

D. Actron ABS BrakeScan. Helps identify why the brake warning light is on and part required for repair. Displays ABS trouble codes and definitions. Coverage for OBDII domestic vehicles 1996 and newer (GM, Ford, Chrysler). Diagnoses wheel speed sensors, ABS solenoids, brake control module, ABS pump motor and more. Retains most recent scan. Includes handset, OBDII cable, soft case and manual. Wt. 2 lbs. 009-47326199.99

E. Actron AutoScanner Plus OBDII Scan Tool. Compatible with all 1996 and newer vehicles. Displays and records live sensor data, freeze frame data. Features bilingual menu and large backlit screen. OBDII code library built into tool. Displays O² monitor test. PC compatible with ability to print. Internet updateable. Includes handset, OBDII cable, USB cable, soft case and CD. Wt. 2.5 lbs. 009-47225179.99

F. Actron AutoScanner OBDII Code Reader. Our best-selling code reader displays code definitions and freeze frame data on screen. Compatible with all 1996 and newer vehicles. Features trilingual menu and OBDII code library built into tool. Features emissions and MIL status. Saves data. Internet updateable via USB port. Wt. 2 lbs. 009-20897129.99

G. Actron PocketScan Plus OBDII Code Reader. New urgency indicator displays urgency of check engine light problem. Features emissions and MIL status and offers access to dynamic web support information on common components, symptoms, and causes to trouble codes. Compatible with all 1996 and newer vehicles. Erases trouble codes and turns off the "Check Engine" light. Easy to use with Auto-link feature. Saves data. Backlit display is easy to read anywhere. Wt. 1 lb. 009-4732579.99

SHOP ON THE GO!
 Visit sears2go.com on your mobile device

H



H. Craftsman 2-piece Gear Puller Set. Features reversible arms and multiple settings so you can access hard-to-reach areas. No need to buy an expansive set of limited-range gear pullers. Made in USA. Guaranteed Forever!® Wt. 5.25 lbs. 009-4736849.99

Catalog/Online EXCLUSIVE
J. SAVE OVER 10% Posi Lock 4-piece Mini Puller Set with Case. Includes four mini pullers: two-jaw (1-ton, 2-ton) and three-jaw (1-ton, 2-ton). Separate prices total \$234.96. Warranted*. Wt. 7.82 lbs. 009-30174209.99



Posi Lock – the Cage® design is the key



K

Posi Lock Gear and Bearing Pullers

Jaw Reach	Jaw Spread	No. of Jaws	Tons ‡	Catalog Number	Wt., lbs.	Price, each
Posi Lock Pullers.						
4 in.	.5 to 5 in.	3	5	009-30164	4.14	\$79.99
6 in.	.5 to 7 in.	3	10	009-30166	8.12	169.99
8 in.	.75 to 12 in.	3	17	009-30168	14.22	207.99
10 in.	1 to 15 in.	3	20	009-30170	16.46	237.99
6 in.	.5 to 7 in.	2	6	009-30176	6.94	149.99
Mini Posi Lock Pullers.						
2 1/4 in.	.25 to 3.25 in.	3	1	009-30162	0.78	\$64.99
3 in.	.25 to 4.5 in.	3	2	009-30163	1.36	49.99
2 1/4 in.	.25 to 3.25 in.	2	1	009-30172	0.7	56.99
3 in.	.25 to 4.5 in.	2	2	009-30173	1.22	62.99
Transmission Bearing Pullers.						
8 in.	2.75 to 14.75 in.	2	1	009-30177	12.12	\$209.99
6 in.	1 to 6.75 in.	3	1	009-30178	7.82	188.99

Catalog/Online EXCLUSIVE
K. Posi Lock 4-piece Hub Puller Adapter Set. Simplify the removal of industrial and automotive fans and blower wheels by providing a solid connection between the puller and fan hub. Includes 5-ton Posi Lock™ puller, one large and one small collar to remove hubs from 0 to 2 inches, plus a tip reducer/extender. Collars feature center opening design for easy alignment on hub. Warranted*. Wt. 8.42 lbs. 009-30160220.99

*Warranted, see page 94a.

Innova® "Check Engine Light" & ABS Diagnostic Tools



Each of these hand-held tools works on all 1996 and newer cars, light trucks, SUVs and minivans — foreign and domestic, including those with CAN. They feature a plug-and-play user interface and patented single-screen display. LEDs indicate if vehicle is ready to pass emissions test. Automatic re-link feature helps verify repairs. Units turn off "Check Engine" light, clear diagnostic codes and reset I/M monitors.



L NEW



M



N

Catalog/Online EXCLUSIVE

L. NEW Innova® 3160 CanOBD2® Professional Scan Tool with ABS Diagnostics. View enhanced live data, manufacturer specific diagnostics, freeze frame data, record data on OBD2 vehicles. View and diagnose anti-lock braking system faults on 1996 and newer GM, Ford and Chrysler vehicles. Turn off both the Check Engine and ABS lights with one tool. ShopSoftware included. Wt. 3 lbs. 009-83278.....**319.99**

Catalog/Online EXCLUSIVE

M. Innova® 1203 CanOBD2® & 1 Tool™. Fast diagnosis of all 1996 and newer vehicles, as well as MOST 1981 to 1995 Ford, GM, Chrysler and Toyota vehicles. Reads and erases codes. Captures and displays freeze-frame data. Links to all OBD2 protocols. English, Spanish and French on-screen definitions. FREE PC software to generate and print custom reports. Internet updateable. Wt. 6 lbs. 009-47217.....**199.99**

Catalog/Online EXCLUSIVE

N. Innova® 1303 CanOBD2® Scan Tool. Pro scan tool retrieves all OEM enhanced trouble codes, live data and freeze frame values for comprehensive diagnostics. Developed by ASE technicians for ease of use, it features a back-lit display with over 20 on-screen values to eliminate tedious setup and scrolling. Displays in English, Spanish and French. Shows O² monitor test results, can turn off "Check Engine" light. Includes PC ShopSoftware with cable that can generate and print detailed reports. Internet updateable. Wt. 3 lbs. 009-47216.....**179.99**

Innova® and Craftsman On Board Diagnostic Tools

Brand Name	Craftsman	Innova	Innova	Innova	Craftsman
Part Number	87702	1203	1303	3160	20899
1996 to Present Coverage including CAN	X	X	X	X	X
Erase and Turn Off Check Engine Light	X	X	X	X	X
Emission Readiness Status LEDs	X	X	X	X	X
PC Software and Internet Updateable	X	X	X	X	X
ScanTool with Enhanced Live Data			X	X	X
ABS Diagnostic Capability				X	
OBD1 Diagnostics for GM, Ford, Chrysler, Toyota/Lexus		X			X

CRAFTSMAN®

P. Craftsman CanOBD2&1 Scan Tool Kit with PC Software and Optional RepairSolutions®.

For all 1996 and newer vehicles and most 1982-95 OBD1 Ford, GM, Chrysler, Jeep, Toyota and Lexus models. OBD2 diagnostics include enhanced live data values, OEM level DTC information, freeze frame details, and retrieves diagnostic modes 1-9. All-in-one display and interface allows quick diagnostics, clear "Check Engine" light and repair confirmation. PC software allows printable reports, data graphing, OBD state emissions readiness light, and Internet updates. Optional RepairSolutions® for most likely VIN-specific repairs, parts costs, labor times, TSB's, recalls, repair procedures and ASE technical support. Trilingual. Wt. 7.5 lbs. 009-20899.....**299.99**



P

Q NEW



*Our new OBD2 tool diagnoses Check Engine Light warnings on most 1996 and newer vehicles

ED'S PICK



Catalog/Online EXCLUSIVE

Q. NEW Craftsman CanOBD2 Diagnostic Tool. Diagnose Check Engine light warnings on 1996 and newer vehicles, including CAN. Plug-and-play interface displays over 20 critical values at once. Retrieve and display manufacturer-specific diagnostic codes, I/M readiness status and freeze frame data. Easily clears stored faults and turns off the "Check Engine" light. Provides coverage for new 2010 model year gas, diesel and hybrid vehicles. Print vehicle diagnostic reports, perform Internet updates and access Optional RepairSolutions® to find the most likely fix with parts and labor costs. USB cable and storage pouch. Trilingual. Wt. 2.5 lbs. 009-87702.....**129.99**

Catalog/Online EXCLUSIVE

R. NEW Craftsman Professional Digital Timing Light. Easy-to-use tune-up tool to view and adjust base timing and overall ignition advance on conventional and DIS (distributorless) 2 and 4-cycle ignition systems. Compact rotating barrel with optically-tuned lens for a clear, bright flash. Digital readout displays rpm, ignition advance, battery/alternator voltage and Dwell readings. Serviceable leads include metal pickup which withstands heat, fits 10 mm ignition wires and uses heavy-duty battery and Dwell clamps. Wt. 3.6 lbs. 009-87701.....**149.99**



R NEW

four operating modes

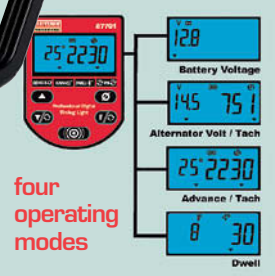

DIAGNOSTIC TOOLS



A NEW

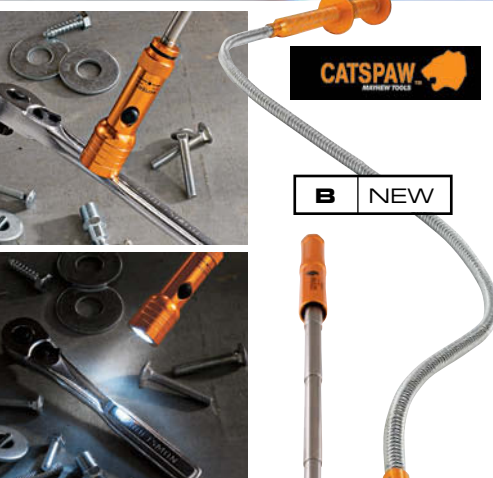

B NEW



C

A. NEW CatsPaw™ Cat Pack Lighted Pick-Up Tools. Set includes a lighted pen/telescoping magnetic pick-up tool with an LED light and 2.2 lbs. of pulling power. Telescoping flashlight pick-up tool features three LED bulbs, push button switch and a magnetic front bezel that has 5 lbs. of pulling power. Comes with pouch, 7 replacement batteries and 2 pen refills. Wt. 1.2 lbs.
009-10322 54.99

B. NEW CatsPaw™ Lighted Pick-Up Claw Tool. Reach and retrieve items in hard-to-get-to places with this innovative tool. Features a flexible shaft with 4-pronged claw lit by a powerful LED. Wt. 0.51 lb.
009-10319 14.99

Catalog/Online EXCLUSIVE
C. CatsPaw™ Magnetic Telescoping Magnetic Grabber. This innovative pick-up tool features a bright 3-LED light that illuminates the work area, and a heavy-duty magnet built into the rim of the light. Lifts up to 5 lbs. Telescopes from 7 1/2 to 22 3/8 inches. Wt. 0.3 lb.
009-46971 19.99



D NEW

VOscope



The VOscope is a unique borescope with a live LED color display instead of an eyepiece viewer

Catalog/Online EXCLUSIVE
D. NEW VOscope® Video Stick. This unique borescope delivers live color images on a LED display for timesaving inspection of tough-to-reach auto parts. Check for damage on car radiators, worn belts, disc brakes, interior of engine and more without removing any parts. Project images on big screen using RCA jack. Snap-on magnetic tip lifts small metal objects. Mirror snaps to camera neck for right angle viewing. Wt. 5 lbs.
009-82943 249.99



E NEW

GENERAL®

INCLUDES
 hard storage case

INCLUDES
 storage bag

>> Check online for SALE PRICING!



F

IDEAL®

E. NEW-SAVE \$50 General® Video Borescope System. Compact, palm-sized, complete close internal inspection system for automotive, HVAC and industrial applications. Includes 3.5-inch TFT monitor, LED light source, camera, video and removable SD memory. Memory allows output on TV or computer. Takes still photos and dynamic video in real time. Rechargeable batteries record for 4 hours continuously. Features data logging function, multiple viewing tips, wide-angle view and multiple video formats. Includes hard case. Wt. 5.25 lbs.
009-87768 1,499.99

Catalog/Online EXCLUSIVE
F. Ideal Professional Data and Video Kit. Featuring thirteen essential tools handpicked by professional installers for twisted pair copper and coax cabling jobs, the kit comes packaged in a large-mouth carrying bag. Kit includes Data T-Cutter®, 7-in-1 screwdriver, UTP stripper, coax stripper, Punchmaster™ II punch-down tool, punch-down blades, Crimpmaster™ crimping tool for RJ-45 plugs, OmniSeal™ compression tool, probe pic and spudger, F/BNC connector tool, VDV MultiMedia™ cable tester, amplifier probe and electrician's scissors. Wt. 2.75 lbs.
009-43390 499.99

*Warranted, see page 94a.

THERMAL IMAGING CAMERAS

Catalog/Online EXCLUSIVE

G. NEW FLIR i40 Thermal Imaging Camera.

This professional-grade unit features a high-resolution (120x120 pixels) visible light camera with fusion picture in picture image capability so you can see an infrared image superimposed in a visible light image. An integrated video lamp provides bright, high-quality physical images for adding accurate visual information to reports — even when working in dimly-lit areas or at night. The state-of-the-art infrared detector with 2% accuracy produces thermal images to show subtle temperature variations that can signal faults in thermally-sensitive equipment. Includes 1GB micro SD memory card, Li-Ion rechargeable battery, power supply, 2-bay battery charger, QuickReport™ software with USB cable, lens cap, hand strap, and heavy-duty case. Wt. 1.32 lbs.

009-87803 4,999.99

Catalog/Online EXCLUSIVE

H. NEW Extech™ i5 Thermal Imaging Camera.

Now you can apply the technology used by NASA to detect minor variations in temperature that may indicate electrical or moisture problems. Detect hot spots, locate water damage sources, find missing insulation and leaky air ducts. Easy to use, this unit offers 0.1°C sensitivity with an accuracy of 2%. Just point toward an object, and crystal-clear images display on the 2.8-inch (80x80 pixels) high-resolution display. Covers temperature range of 32°F to 484°F and stores up to 5,000 images. Includes 4-hour charger and all the necessary software to save and share your thermal images. Wt. 0.75 lb.

009-87802 2,999.99



technology used by NASA



G NEW



both thermal imaging units powerload images to a PC quickly and easily with SD card or USB cable

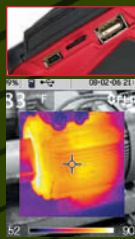

fusion picture-in-picture image

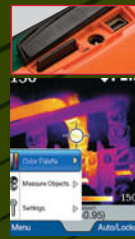

high-resolution screen

H NEW



DIAGNOSTIC TOOLS

J. NEW Craftsman Professional 1400-Degree Non-Contact Laser-Directed Infrared Thermometer with K-Type Temperature Probe.

Measures 1-inch spot from 13 inches. Laser pointer identifies target. Molded housing, backlit display. Displays highest, lowest average and MAX minus MIN values. Thermocouple allows surface and submerged readings. Auto off. 9V battery (not included). Measures -58°F to 1472°F. Warranted*.

Wt. 0.54 lb. • 034-81998 99.99

Catalog/Online EXCLUSIVE

K. Craftsman Professional 1800-Degree Non-Contact Dual Laser Infrared Thermometer.

Lasers converge to define most accurate measurement spot; a 1 inch spot from 30 inches. 150 millisecond response to measure fast moving parts. Adjustable emissivity increases accuracy for different surfaces. Molded housing, white backlit display. Auto off. 9V battery (not included). Measures -58°F to 1832°F. Warranted*. Wt. 0.4 lb. • 034-14079 179.99

L. Craftsman 1000-Degree Non-Contact Laser-Directed Infrared Thermometer.

Measures a 1-inch spot from 8 inches. Built-in laser pointer identifies target area. Double molded housing with backlit display. Auto off. 9V battery (not included). Measures -58°F to 1000°F. Warranted*. Wt. 0.4 lb. • 034-50466 79.99



J NEW

K

L



ProVison Inspection Scopes



Catalog/Online EXCLUSIVE

M. ProVison Fiber-Optic Borescopes. These revolutionary inspection tools feature innovative fiber-optic technology with a flexible cable that allows you to see into engines, behind walls, down drains and more. Illuminated with a bright halogen bulb, the high-resolution lens provides a clear 40-degree field of view of objects from 18 to 36-in. away. Allows one-handed focusing and light activation. Choose from "obedient" cable that maintains your desired fixed position until readjusted, or "flexible" cable that bends in any direction to allow precise viewing. Complete with replacement bulb, magnet, mirror and molded storage case. All scopes use two AA batteries (not included). Capable of 6,000 pixel resolution capture.

009-47280 18-inch Obedient ProVison Scope Wt. 1.52 lbs 159.99

009-47281 36-inch Obedient ProVison Scope Wt. 2.6 lbs 199.99

009-47282 18-inch Flexible ProVison Scope Wt. 1.36 lbs 159.99

009-47283 36-inch Flexible ProVison Scope Wt. 2.34 lbs 199.99

Catalog/Online EXCLUSIVE

N. ProVison Camera Coupler. 37 mm coupler attaches all ProVison Borescopes to video, digital or film cameras. Wt. 1.5 oz. 009-47622 49.99

Catalog/Online EXCLUSIVE

P. Two-in-One Flexible/Obedient 18- and 36-inch Convertible Borescopes. Obedient shaft slides over the existing flexible shaft and screws on to the base to create an obedient scope. Features stay-on self-timed switch with LED indicator and threaded mirror and magnet. Capable of 7,400 pixel resolution capture.

18-inch Convertible Borescope. Wt. 1.36 oz. 009-47620 209.99

36-inch Convertible Borescope. Wt. 2.35 oz. 009-47621 249.99



carbon steel set



CARBON STEEL SETS

Craftsman Carbon Steel Sets in Blow-Molded Case. Hardened, precision-ground and polished carbon steel surfaces make chip removal easy. Hex-shaped dies permit use of sockets and wrenches as well as die stocks. Rust-resistant satin finish for smooth cuts with less friction. See charts at right for individual components. Limited warranty*.

Catalog/Online EXCLUSIVE

A. 107-piece Combination Set. Combines inch and metric sizes. (See chart at right.) Wt. 18.6 lbs.
009-52386 **299.99**

B. 75-piece Combination Set. Combines inch and metric sizes. (See chart at right.) Wt. 9.5 lbs.
009-52377 **199.99**

Also Available

Craftsman 39-piece Sets in Blow-Molded Case. Choose between inch or metric sizes. (See chart at right.)

Inch. Wt. 4.25 lbs
009-52382 **99.99**

Metric. Wt. 5 lbs.
009-52383 **99.99**



Laser-Etched Tap & Die Sets

Laser etching makes finding tools easy with detailed, legible information, clearly identifying part number, size, thread count and national coarse or fine thread. Produce Class II fit specified by National Bureau of Standards.

Standard Sizes: Tap & Die Sets. See items on this page.

Thread size, inches	(A) 107-pc.	(B) 75-pc.	(Inch) 39-pc.
(Taps & Dies)			
1/4-20NC	X	X	X
5/16-18NC	X	X	X
3/8-16NC	X	X	X
7/16-14NC	X	X	X
1/2-13NC	X	X	X
9/16-12NC	X		
5/8-11NC	X		
3/4-10NC	X		
1/4-28NF	X	X	X
5/16-24NF	X	X	X
3/8-24NF	X	X	X
7/16-20NF	X	X	X
1/2-20NF	X	X	X
9/16-18NF	X		
5/8-18NF	X		
3/4-16NF	X		
4-40	X	X	X
6-32	X	X	X
8-32	X	X	X
10-24	X	X	X
10-32	X	X	X
12-24	X	X	X
1/8-27NPT	X	X	X
1/4-18NPT	X		

Accessories: (SAE & MM)

Die stock	2	1	1
T-handle tap wrench	1	2	1
Tap, reamer wrench	2	1	1
Thread gauge	2	2	1
Screw extractor	5		
Screwdriver	1	1	1

Metric Sizes: Tap & Die Sets. See items on this page.

Thread size, mm	(A) 107-pc.	(B) 75-pc.	(Metric) 39-pc.
(Taps & Dies)			
3 x 0.50		X	X
3 x 0.60	X	X	X
4 x 0.70	X	X	X
4 x 0.75	X	X	X
5 x 0.80	X	X	X
5 x 0.90	X	X	X
6 x 1.00	X	X	X
7 x 1.00	X	X	X
8 x 1.25	X	X	X
9 x 1.00	X	X	X
9 x 1.25	X	X	X
10 x 1.25	X	X	X
10 x 1.50	X	X	X
11 x 1.50	X	X	X
12 x 1.50	X	X	X
12 x 1.75	X	X	X
14 x 1.25	X		
14 x 2.00	X		
16 x 1.50	X		
16 x 2.00	X		
18 x 1.50	X		
18 x 2.50	X		
1/8-28 BSP	X	X	X
1/4-19 BSP	X		

Catalog/Online EXCLUSIVE

C. Imperial Automotive Tubing Bender.

Featuring a "quick-release" mechanism, unit bends 3/8, 5/16, 1/4, 3/16-inch tubing as well as brake, A/C and transmission lines. Features window on upper handle for visual verification of exact bends according to markings. Wt. 2 lbs.

009-50509 **29.99**

D. Imperial Automotive A/C Manifold.

This complete kit for automotive A/C service has 60-inch hoses and high-quality R-134a high and low side couplers. Made of solid brass, the manifold body can easily be converted for use with R-12 and other refrigerants. High-performance hose has an 800 psi working and 4,000 psi burst pressure. Protective boots shield precision gauges with shock resistance. Guaranteed Forever!* Wt. 5.5 lbs.

009-21025 **119.99**

E. Imperial 45-degree Double Flaring Kit.

For automotive, HVAC and plumbing use, with a forged steel yoke and a swivel-type flaring cone of hardened steel with chrome finish. For 3/16, 1/4, 5/16, 3/8 and 1/2-inch O.D. tubing. Includes case. Made in USA. Guaranteed Forever!* Wt. 3.5 lbs.

009-50463 **39.99**



180-degree bend



Catalog/Online EXCLUSIVE

F. Imperial 5-piece Metric Ratcheting Line Wrench Set.

Includes sizes 10 thru 14 mm plus pouch. Wt. 2 lbs.

009-50501 **69.99**

Catalog/Online EXCLUSIVE

G. Imperial 7-piece Ratcheting Line Wrench Set.

These comfort-grip wrenches allow ratcheting service of tubing such as brake, hydraulic and A/C lines. Includes 3/8 to 3/4-inch sizes plus pouch. Made in USA. Guaranteed Forever!* Wt. 2.3 lbs.

009-50461 **79.99**



National Course National Fine Metric

Dies-In.	Taps-In.	Dies-In.	Taps-In.	Dies	Taps
1/4-20	1/4-20	1/4-28	1/4-28	6-1	6-1
5/16-18	5/16-18	5/16-24	5/16-24	8-1.25	8-1.25
3/8-16	3/8-16	3/8-24	3/8-24	10-1	10-1
7/16-14	7/16-14	7/16-20	7/16-20	10-1.25	10-1.25
1/2-13	1/2-13	1/2-20	1/2-20	10-1.5	10-1.5
9/16-12	9/16-12	9/16-18	9/16-18	11-1.5	11-1.5
5/8-11		5/8-18		12-1.25	12-1.25
				12-1.5	12-1.5
				12-1.75	12-1.75
				14-1.5	14-1.5

One Inch Rethread File

in 8 sizes: 11 thru 14, 16, 18, 20, 24 tpi.

One Metric Rethread File

in 8 sizes: .75, 1, 1.25, 1.5, 1.75, 2, 2.5, 3 mm tpi.

J. Craftsman Adjustable T-Handle Ratchet Tap Wrench.

For right- or left-handed operation. Lock for non-ratchet use. Self-centering replaceable jaws. Warranted*.

J.	Tap Capacity	Catalog Number	Wt., lbs.	Price
0	0-1/4-in., 1.6-6.3 mm	009-4065	0.5	\$24.99
5	5/16-1/2-in., 6-12.5 mm	009-4064	1.19	29.99



The Original Patented
GEARWRENCH
Ratcheting Combination Wrench

Catalog/Online EXCLUSIVE
K. NEW GearWrench® 11-piece Tap and Die Drive Tool Set. Twist-lock guide reduces "back walk" and keeps dies centered. With "T" wrench in 3/8-in. and 1/2-in. drive, small, medium and large tap adapter, sliding "T" adapter, 3/8-in. male and female extension adapters, small die and large hex die adapters, hex key. Blow-molded case. Wt. 5 lbs. **009-87681 129.99**

Catalog/Online EXCLUSIVE
L. NEW GearWrench® 114-piece Carbon Steel Tap and Die Set. Twist-lock guide. Auto-lock feature for safe removal of tap adapter. Reversible lever with 5-degree ratcheting arc. Adding 1/2-inch drive allows for a total range of #4 to 3/4-inch and 3 to 18 mm. 24 metric taps, 24 inch hex dies, 24 metric hex dies, 3/8-in. drive "T" wrench, small and medium tap adapter, die adapter, sliding "T" adapter, male and female extension adapters, 1/2-inch drive "T" wrench, large tap adapter, die adapter, screw extractor, SAE and metric thread gauge, hex key and case. Wt. 20 lbs. **009-87680 299.99**

Also Available
GearWrench® 75-piece Carbon Steel Tap and Die Set. With same features and accessories as L above. Includes ratcheting "T" wrench, small and medium tap adapter, die adapter, sliding "T", 34 taps and 34 dies (inch and metric), pitch gauge, #5 screwdriver and case. Wt. 7.5 lbs. **009-34925 199.99**

Catalog/Online EXCLUSIVE
M. GearRatchet® 49-piece Combination Set. Vortex® hollow socket system eliminates the need for deep sockets. Use with GearRatchet handle for increased torque strength. 13 mm drive size includes nine inch sockets (5/32 thru 1/2 in.), 13 metric sockets (3.5 thru 13 mm), handle, two extensions (1 1/4 and 3 in.), quick-release adapter, spinner handle. 21 mm drive size includes seven inch sockets (3/8 thru 3/4), 10 metric sockets (10 thru 19 mm), handle, two extensions (1 1/4 and 3 in.), two quick-release adapters (1/4 and 3/8 in.). Wt. 4.63 lbs. **009-30049 49.99**

N. GearWrench® Serpentine Belt Tool Set with Special GearWrench. This set covers 100% of all vehicles. Provides easy access with both crow's-foot and socket sizes. Special GearWrench provides excellent access and ease of use. Set includes seven 6-point metric sockets (13 thru 19 mm), three crow's-foot (13 thru 15 mm), three adapters (3/8, 1/2 and 3/4 in.), long bar and special GearWrench. Includes case. Wt. 2.4 lbs. **009-47098 59.99**

Catalog/Online EXCLUSIVE
P. NEW GearWrench® 20-piece Screwdriver Set with Indexing Pry Bar. Includes a full range of the most popular screwdriver sizes ranging from 1/4 x 1 1/2 in. to 3/8 x 8 in. slotted, #0 x 2 1/2 to #3 x 6 in. Phillips, two Torx®, six precision screwdrivers, 8-in. indexing pry bar. Wt. 5.8 lbs. **009-94672 99.99**

114-PIECE

SHOP ON THE GO!
Visit sears2go.com on your mobile device



Q. GearWrench® 7-piece Magnetic Oil Drain Plug Socket Set. Remove hot, rounded and difficult-to-reach drain plugs. Magnetic socket core prevents plug from falling into drain pan during use. Includes 3/8-inch drive GearRatchet, 13-19 mm sockets in color-coded anodized aluminum and knurled spreader rings. Includes case. Wt. 2.8 lbs. **009-30793 59.99**

Catalog/Online EXCLUSIVE
R. NEW GearWrench® 2-piece Double-X Hemostat Set. Double-X designed for extra long reach with minimum handle movement. Hold and clamp hard-to-reach objects. Uses include vacuum lines, electronics, and soldering. Includes straight and 45-degree double-X hemostats. Separate prices total \$59.98. Wt. 0.44 lb. **009-87673 49.98**

Catalog/Online EXCLUSIVE
S. GearWrench® 2-piece Double-X Pliers Set. Compound joint for access with minimal handle movement and serrated tips deliver precision grip. Set includes straight and 45-degree double-X pliers. Separate prices total \$49.98. Wt. 2.2 lbs. **009-50830 39.98**

Catalog/Online EXCLUSIVE
T. NEW GearWrench® 3-piece Long-Reach Torx® Screwdriver Set. Used for headlight and other deep access fasteners. Dual material cushion-grip handles for added comfort and leverage. Set includes Torx® sizes T15, T20, T25. Wt. 1.31 lbs. **009-87677 29.99**

*Warranted, see page 94a.



E. Craftsman 7-piece Fiberglass Handle Body and Fender Repair Tool Set. The most commonly used hammers, dollies and spoon for general body work. All with fiberglass handles for greater strength and shock absorption. Each alloy steel tool features polished working surfaces designed and balanced to do the job right. Includes cross chisel, shrinking and utility pick hammers, light dinging spoon, and toe, heel and general-purpose dolly blocks. Fiberglass handles. Made in the USA. Wt. 12.2 lbs.
009-47297 **179.99**

Also Available
Martin Tools 7-piece Wooden Handle Body and Fender Repair Tool Set. Set includes all the items listed in "A" above, but with wooden handles. Made in USA. Wt. 9.5 lbs.
009-50467 **179.99**

Catalog/Online EXCLUSIVE
F. Craftsman 4-piece Fiberglass Handle Body and Fender Hammer Set. Set includes curved cross chisel hammer, general-purpose pick hammer, utility pick hammer and door skin hammer. Wt. 4.5 lbs.
009-47296 **109.99**

Catalog/Online EXCLUSIVE
G. NEW Craftsman 4-piece Body and Fender Dolly and Spoon Set. Smooth out dings and dents in your damaged vehicle with this tough, portable anvil set. Includes toe dolly, heel dolly, general-purpose dolly and finishing spoon. Crafted in precision ground forged alloy steel. Wt. 8 lbs.
009-83228 **117.99**



CRAFTSMAN

Catalog/Online EXCLUSIVE
A. Craftsman 12-piece Quarter-Turn® Convertible Retaining Ring Pliers. Requires only a quarter turn to convert for internal or external rings. This complete set includes: .038, .047, .070 and .090-in. straight tips, .038, .047, .070 and .090-in. 45-degree tip angle, .038, .047, .070 and .090-in. 90-degree tip angle. Includes case. Made in USA. Wt. 5.2 lbs.
009-50464 **99.99**

Catalog/Online EXCLUSIVE
B. Craftsman Heavy-Duty Retaining Ring Pliers Set. Kit services rings 1 1/2 to 4 inches. Spring-ratchet assembly and cushioned grips for comfort. Includes eight pairs of replaceable tips. Made in USA. Wt. 3 lbs.
009-47219 **69.99**

Catalog/Online EXCLUSIVE
C. Craftsman 3-piece Hose Pinch Pliers Set. Friction grip pinches hoses at any position without teeth, gears or levers to engage or wear. Universal clamping mechanism locks automatically. Comfort grips. Separate prices total \$59.97. Made in USA. Wt. 2.75 lbs.
009-47218 **49.99**

Also Available
009-47050 3/4-inch. Wt. 0.29 lb. **9.99**
009-47051 1 1/4-inch. Wt. 0.36 lb. **15.99**
009-47060 2 1/2-inch. Wt. 1.35 lbs. **29.99**

D. Craftsman 5-Pocket Fender Cover. Innovative cover keeps vehicle finish safe from grime and scratches. Made of thick, slip-resistant vinyl that cleans up easily. Five nylon mesh pockets offer rugged, handy storage. Large 35 x 27-inch design. Features vintage Craftsman logo. Warranted*. Wt. 2.2 lbs.
009-51163 **19.99**



Catalog/Online EXCLUSIVE
H. Craftsman 5-piece Thickness and Spark Plug Gauge Set. Performs virtually all automotive, industrial, other gapping requirements. Includes two spark plug wire gauges, offset gauge for valve tappets, ignition/wire combination gauge, master feeler gauge set with 30 steel and six brass blades. With sleeved vinyl pouch. Guaranteed Forever!® Wt. 0.75 lb.
009-40815 **19.99**

Catalog/Online EXCLUSIVE
J. Craftsman 5-piece Thinwall Flip Socket Set. Ideal when space is limited, these sockets are the same diameter as chrome sockets, with the strength of an impact socket. Flip design gives each socket two sizes with a 1/2-inch drive at center. May be used with impact gun. Includes case. Made in USA. Warranted*. Wt. 2.25 lbs.
009-34917 **39.99**

Catalog/Online EXCLUSIVE
K. Craftsman 6-piece Double-Duty Flip Socket Set. Combines a 6-point socket with a flip-side 6-fluted (bolt-out) socket for removing lug nuts and damage lug nuts. May be used with impact gun. Includes metric and fractional lug nut sizes for most domestic and foreign cars and light trucks. Comes with case. Made in USA. Warranted*. Wt. 2.75 lbs.
009-34916 **79.99**

Catalog/Online EXCLUSIVE
L. Craftsman 3-piece Lug-Out Wheel Lug and Lock Flip Socket Set. Remove damaged and rounded wheel lugs and wheel locks with ease. Set features three lug nut removers and pouch. Wt. 1.5 lbs.
009-47392 **29.99**

BUY ONLINE
PICK-UP IN STORE!
on eligible items

M. Craftsman 5-piece Pickle Fork Kit. Five tools in one for versatility and value. Use to separate ball joints, tie rods, Pitman arms and more. Includes three forks with heavy-duty forgings and two heat-treated alloy steel handles — one for hammering, the other for use with an air hammer (0.401-inch shank). Wt. 3.94 lbs.
009-30308 **39.99**

N. Craftsman Compression Tester. A great tester for automotive tune-up and testing. Includes a full assortment of adapters for any automotive or small engine application. Shock-resistant gauge that reads 0 to 300 psi/ 0 to 20 Kpa x 100. Wt. 3 lbs.
009-47089 **49.99**



Catalog/Online EXCLUSIVE

P. Mityvac® Air-Operated Fluid Evacuator. Works with your air compressor to extract most automotive liquids, including transmission, brake fluid, coolant and gear and engine oil. Polyethylene construction. Includes three 5 foot flexible tubes for fluid removal and brake bleeder adapter kit. 8.8-liter capacity. Wt. 8 lbs.

009-4783699.99

Catalog/Online EXCLUSIVE

Q. Mityvac® Fluid Evacuator and Manual Operated 8.8 Liter Fluid Evacuator and Dispenser. No compressor needed! Provides a simple, clean way to evacuate and dispense a wide variety of fluids, including oil, coolant, brake fluid and more. Automatic flow valve control prevents overfilling. Automatically shuts off at 8 liters. Comes with 5 feet of flexible hose and two rigid dipstick tubes for engine oil removal. Wt. 7 lbs.

009-4227779.99

Catalog/Online EXCLUSIVE

R. Mityvac® Shop Air Brake Bleeder/Evacuator. Uses shop air to bleed brakes or hydraulic clutches. Features large 1.9-quart reservoir that removes easily for emptying. Thumb throttle for flow rate control. Automatic shutoff prevents overflow. Includes all the accessories needed for bleeding and evacuating. Comes with automatic refill kit. Wt. 4.8 lbs.

009-42276129.99

Catalog/Online EXCLUSIVE

S. NEW Mityvac® MV8500 Silverline Elite Automotive Kit. Ideal for performing hundreds of automotive diagnostic and mechanical tests and one-person brake bleeding. Includes diaphragm style compound pressure/vacuum gauge, hand vacuum/pressure pump with 2-inch compound gauge, fluid reservoir bottle with fluid transfer and storage lids, 7 tapered adapters for connecting to tubing from .09 to .50 inches, 2 tapered manifold plugs, 2 universal bleed screw adapters, 12 vacuum cap plugs, vacuum line T-adapter, (2) 1/4 x 24-inch connection tubes, 5/32 x 1/4-inch tubing adapter, 3 connection tubes, rubber cupped adapter, master cylinder refill kit, case and manual. Wt. 4 lbs.

009-8325779.99



Catalog/Online EXCLUSIVE

T. Mityvac® Digital Gasoline Engine Compression Test Kit. Features electronic tester that memorizes peak compression value for each cylinder (up to 12 cylinders). Review values at the push of a button. Includes everything to perform wet and dry compression tests used to detect ring or cylinder head problems, sticking valves, blown head gaskets and more. Includes adapters for motorcycle, marine and small engines. Air-hold adapter for performing valve seal repairs without removing the cylinder heads. Uses standard 9-volt battery. Auto shutoff after 3 minutes. Rubber boot protects from drops. Sealed, grease- and oil-resistant gauge face. Warranted*. Wt. 4.9 lbs.

009-47043129.99



AUTOMOTIVE SPECIALTY

Catalog/Online EXCLUSIVE

U. Lisle 11-piece Master Tap Socket Set. Perfect for places a T-handle tool won't fit. Eleven sockets fit all numbered and fractional MCTI standard taps up to 3/4-inch. Fits 1/8-inch NPT taps and metric taps through 18 mm. Comes with vinyl holder. Wt. 2.25 lbs.

009-4776459.99

Catalog/Online EXCLUSIVE

V. Lisle 34-piece Master Torx® Set. Organizes all your Torx® bits, tamper-resistant Torx® bits and Torx® sockets in a storage case with window. With 12 Torx® bits T10 thru T60, 10 tamper-resistant Torx® bits T10 thru T55, plus 1/4 and 3/8 in. bit holders and 10 Torx® sockets E5 thru E20. Includes storage case. Wt. 3.25 lbs.

009-4725879.99



Catalog/Online EXCLUSIVE

W. Lisle Master Disconnect Set for Air Conditioning and Fuel Lines.

For spring lock and quick disconnect couplings used on A/C and fuel lines for Ford, GM and Chrysler vehicles. Set of six standard and six angled tools for 5/16, 3/8, 1/2, 5/8, 3/4 and 7/8-inch lines. Includes tools for 3/8-inch GM flex fuel capable filters; 5/16 and 3/8-inch GM fuel modules; 3/8 and 1/2-inch Ford transmission oil cooler lines; plus 5/16 x 3/8-inch scissor disconnect and Ford coupler disconnect tools. Wt. 1.75 lbs.

009-4775559.99



Catalog/Online EXCLUSIVE

X. NEW Lisle 11-piece End Cap Filter Wrench Sets for Asian Vehicles.

A comprehensive selection of filter wrenches for use on the most popular Asian vehicles including Toyota, Honda, Nissan, Suzuki, Hyundai, Kia and more. Use with 3/8-inch drive. With plastic case. Wt. 4.9 lbs.

Size (mm)	Flutes	Size (mm)	Flutes
65	14	80	15
68	14	82	15
74	14	88.4	15
74/76	15	93	15
76	14	93	36
76	30		

009-8294559.99

Also Available

NEW Lisle Cap and Filter Socket Set for European Vehicles. Includes 8 end cap wrenches and 4 canister sockets for BMW, Mercedes, VW/Audi and more. Use with 3/8-in. drive. With plastic case. Wt. 5.32 lbs.

Size (mm)	Flutes	Size (mm)	Flutes
68	14	86	16
74/76	15	93	15
76	14	93	45
86	14	96	18

Low Profile Hex Sockets: 24, 27, 32, 36 mm.
009-8294769.99

Also Available

Lisle Cap Style Oil Filter Wrench Set. Includes 10 end cap wrenches for the most popular domestic and some import applications. Use with 3/8-inch drive. With plastic case. Wt. 5.44 lbs.

Size (mm)	Flutes	Size (mm)	Flutes
65/67	14	80	15
68	14	86	16
74/76	15	93	15
76	14	93	36
76	30	100	15

028-2052549.99



AA NEW

Y. Vacula® DX12 Fluid Evacuator. Heavy-duty unit features a two-way throttle control to extract or dispense any type of non-explosive fluid. Powered by compressed air, unit has a vacuum pre-charging function that enables it to work remotely. State-of-the-art design creates a powerful vacuum for high efficiency. Built-in silencing lowers noise level. Includes suction/dispersing hose, 21 in. and 39 in. probes. Wt. 8.7 lbs.

009-47322399.99

Catalog/Online EXCLUSIVE

Z. Vacula® DX2.5 Brake Bleeder. Built to perform, this unit is highly effective at bleeding brakes and more. Features two-way throttle control that allows unit to extract or dispense any type of non-explosive fluid. Built-in silencing feature lowers noise level. Includes probe, brake bleeder hose with universal adapter and emptying hose. Wt. 4.4 lbs.

009-47323279.99

Catalog/Online EXCLUSIVE

AA. NEW Vacula® Brake Bleeder Refiller Bottle.

An innovative solution to streamlining the brake fluid replacement process. While bleeding out old brake fluid from lines and reservoir, the refiller automatically fills system with new brake fluid. Ideal for one-operator process. Guards against air entering brake system. Wt. 0.75 lb.

009-7954659.99

*Warranted, see page 94a.



ALL KITS INCLUDE HINGED LID STORAGE

Catalog/Online EXCLUSIVE

A. KD Tools 15-piece Brake Service Set. Adjust brake drum/shoe clearance, remove/install brake pads or shoe return springs. Includes drum brake adjusting tool, brake spring pliers, universal brake spring tool, disc brake piston tool, GM-Ford disc brake piston tool, disc brake spreader, heavy-duty truck brake spring tool, 8 hex sockets, instruction card and case. Wt. 6.2 lbs.
009-47753 79.99

Catalog/Online EXCLUSIVE

B. KD Tools 8-piece Master Sensor Socket Set. Specially designed sockets and tools to remove and install oxygen sensors, oil pressure sending units and vacuum switches. Sockets designed to remove sensors with wires or vacuum tubes. With laminated instruction card. Case with removable lid for tool drawer storage. Wt. 5.68 lbs.
009-47020 59.99

Catalog/Online EXCLUSIVE

E. KD Tools Power Steering Pump Pulley Kit. Remove and install power steering pump pulleys of most domestic vehicles. Adapters for GM 3.1 L, 3100, 3400, and 3800 V6 engines, GM 2.3 L Quad 4, Ford 4.6 L, 5.4 L and 5.8 L modular V8s. Fits 1 1/8, 1 1/4, 1 5/16 and 1 3/8-in. pulley hub diameters. With quick disconnect tool for GM 1/2, 3/4 and 1-ton pickups. Includes KDT3893 disconnect tool and KDT41561 and KDT41562 bushing/screw sets. Wt. 2.5 lbs.
009-47022 39.99

Catalog/Online EXCLUSIVE

G. KD Tools Bearing Race and Seal Set. Install tapered bearing races and seal without damage to component or housing. Includes driver handle and 1.565, 1.750, 1.961, 2.325, 2.470, 2.555, 2.830, 2.995 and 3.180-in. driver sizes. Blow-molded case with laminated application reference card. Wt. 4.74 lbs.
009-47007 59.99

Catalog/Online EXCLUSIVE

C. KD Tools Slide Hammer Puller Kit. For flange-type axles, oil seals and other press fit parts. Set jaws for 2- or 3-jaw internal or external jobs. Includes shallow and deep flange, slide hammer, 2- and 3-way yokes, center bolt and cone, 3-piece adapter set, leg package with screws. Wt. 17 lbs.
009-47008 99.99

Catalog/Online EXCLUSIVE

F. KD Tools 12-piece Fuel Line Disconnect Kit. Tools to separate fuel, filter, transmission, air conditioning fittings and fuel tank return lines on most vehicles and heavy equipment. Includes these tools: GM & Ford disconnect, Ford fuel line coupling, Ford hydraulic clutch line disconnect, Chrysler quick disconnect coupler, Ford EFI fuel line with hair pin connector, GM hydraulic clutch line disconnect, GM transmission oil cooler line disconnect, Ford oil cooler line disconnect, 1/4, 5/16, 3/8-in. fuel line disconnects, oil cooler disconnect and replacement bands. With laminated instruction card. Case with removable lid for tool drawer storage. Wt. 2.07 lbs.
009-47021 49.99

Catalog/Online EXCLUSIVE

H. KD Tools 3-piece Push Pin Pliers Set. Set includes two push pin pliers and one body clip pliers. Ideal for removing plastic pushpins used to attach plastic housings and covers. Includes 80-degree offset pliers for tight wheel well access. Wt. 1.3 lbs.
009-34924 34.99

Catalog/Online EXCLUSIVE

D. KD Tools 14-piece Master Tubing Service Set. Everything you need for complete tubing service. Double flare, bend, cut, ream and deburr. Includes mini tubing cutter, bender, deburring tool, flaring adapter kit, holding bar, yoke, instruction card and case. Wt. 6.1 lbs.
009-47752 69.99

Catalog/Online EXCLUSIVE

J. KD Tools 8-piece Fan Clutch Water Pump Service Kit. Features the tools needed to remove fan clutch pulleys to change water pump. For most vehicles with bolt-on pulleys and newer Chrysler engines with press-on pulleys. Includes universal pulley holder, pin set (small 5 x 8 mm and large cam pins 6 x 10 and 7.5 x 18 mm), and five fan nut wrenches (22, 26, 40, 47, 50 mm). Instruction card and case with removable lid for tool drawer storage. Wt. 1.8 lbs.
009-51177 79.99

Catalog/Online EXCLUSIVE

K. KD Tools 4-piece Pro-Swivoil™ Oil Filter Wrench Set. 180-degree swivel action. Stainless steel bands. Includes small (64 to 76 mm), medium (73 to 83 mm), large (89 to 99 mm) and extra-large (96 to 111 mm). Wt. 3.75 lbs.
009-47754 44.99



MORE TO EXPLORE
 >> at sears.com!



Catalog/Online EXCLUSIVE

L. NEW KD Tools 2-piece Flat Band Hose Clamp Pliers Set. These specialty pliers are designed for use with 3/8 to 1 1/2-inch hose clamps. Heavy-duty construction features improved strength, new locking feature and dual-tipped handles. Set includes straight hose clamp pliers and 45-degree angled straight hose clamp pliers. Wt. 2 lbs.
009-87683 39.99

Catalog/Online EXCLUSIVE

M. KD Tools Magnetized Extended Universal Spark Plug Sockets. Eliminate the struggle of changing spark plugs. The magnetized core holds spark plug in place and the extra long reach makes it easier to access tight spaces. One-piece design, so the socket can't detach from extension bar. Includes 4, 6 and 11-inch 5/8 in. socket universal extensions and storage case. Wt. 1.9 lbs.
009-42274 36.99



28-PIECE SET



20-PIECE SET

Craftsman punches and chisel sets feature bright red E-coat for high visibility, easy cleanup and double the corrosion protection. A complete collection is available online at sears.com/shoptools

Catalog/Online EXCLUSIVE
N. Craftsman 28-piece Punch, Chisel and Alignment Set. Tough chrome vanadium steel construction, double heat-treated for durability and impact resistance. Rust-resistant finish. Includes four 4-inch nail sets (1/32, 2/32, 3/32, 4/32 in.); one prick punch (3/8 x 4 1/2 in.); two center punches (3/8 x 4 1/2, 1/2 x 6 in.); six pin punches (1/16 x 4, 3/32 x 4, 1/8 x 4 1/2, 5/32 x 5, 3/16 x 5, 1/4 x 5 1/2 in.); four alignment tools (5/32 x 7, 3/16 x 9, 1/8 x 5 1/2, 1/4 x 12 in.); 16-inch pry bar; six cold chisels (1/4 x 4, 3/8 x 5, 1/2 x 5 3/4, 5/8 x 6, 3/4 x 6 1/2, 7/8 x 7 1/2 in.); four 12-inch cold chisels (1/2, 5/8, 3/4, 7/8 in.). Separate prices total \$171.28. Wt. 9.47 lbs.
009-43164 **79.99**

Catalog/Online EXCLUSIVE
P. Craftsman 20-piece Super-Duty Punch and Chisel Tool Set. Includes six roll pin punches (1/8 x 4 1/2, 5/32 x 5, 3/16 x 5, 7/32 x 5, 1/4 x 5 1/2, 5/16 x 5 1/2 in.); six pin punches (1/16 x 4, 3/32 x 4, 1/8 x 4 1/2, 5/32 x 5, 3/16 x 5, 1/4 x 5 1/2 in.); six cold chisels (1/4 x 4, 3/8 x 5, 1/2 x 5 3/4, 5/8 x 6, 3/4 x 6 1/2, 7/8 x 7 1/2 in.) and two center punches (3/8 x 4 1/2 in., 1/2 x 6 in.). Separate prices total \$117.10. Guaranteed Forever!® Wt. 4.75 lbs.
009-43163 **49.99**

Catalog/Online EXCLUSIVE
Q. Craftsman 11-piece Cold Chisel Set with Pry Bar. Includes 10 cold chisels (1/4 x 4, 3/8 x 5, 1/2 x 5 3/4, 5/8 x 6, 3/4 x 6 1/2, 7/8 x 7 1/2, 1/2 x 12, 5/8 x 12, 3/4 x 12, 7/8 x 12 in.); and one 16-inch pry bar. Separate prices total \$77.20. Guaranteed Forever!® Wt. 6.67 lbs.
009-43161 **49.99**

R. Craftsman 6-piece Long Pin Punch Set. Sizes 5/32 x 7 1/2, 3/16 x 7 1/2, 7/32 x 7 1/2, 1/4 x 7 1/2, 1/4 x 7 1/2, 5/16 x 7 1/2 and 3/8 x 7 1/2 in. Separate prices total \$35.94. Guaranteed Forever!® Wt. 1 lb.
009-43160 **24.99**

Also Available
Craftsman 16-inch Rolling Wedge Bar. 90-degree polished rolling head. 9/16-inch diameter. Wt. 1.25 lbs.
009-42892 **18.99**

Catalog/Online EXCLUSIVE
S. Craftsman Punch and Chisel Holder. Designed to keep hands away from shaft of chisels to avoid being accidentally struck and reduce hand vibration. Securely clamps onto hex stock up to 3/4-inch. Butyrate handle for chemical resistance. Forged head for durability. Heat-treated head and screw for long life. Made in USA. Wt. 0.4 lb.
009-42839 **12.99**

PUNCH, LINE-UP TOOL, CHISEL & PRY BAR OPEN STOCK AT SEARS.COM/SHOPTOOLS



11-PIECE SET

6-PIECE SET



Catalog/Online EXCLUSIVE
T. KD Tools 11-piece Mini Punch and Chisel Set. Scaled for access to hard-to-reach areas. Holder provides better access and finger protection. Can be used with or without holder. Includes two flat chisels (10 and 13 mm), cape chisel, three taper punches (2, 3 and 4 mm), three pin punches (3, 4 and 5 mm), two center punches (0 and 3 mm) and protective handle. Wt. 1.5 lbs.
009-42279 **29.99**

MAYHEW TOOLS
Mayhew® punches & chisels
 Celebrating 150 years of excellence, Mayhew® offers the finest quality punches and chisels. Crafted in high-grade S-2 steel with full shank heat treating for superior tensile strength and toughness. Black oxide finish for corrosion resistance. Sets come in leather pouch. Warranted*.

Catalog/Online EXCLUSIVE
U. NEW-SAVE *20 Mayhew® 14-piece 150-year Anniversary Punch and Chisel Set. Set in a genuine leather pouch, this collectible set is a part of American industrial history. Sizes include 1/4, 3/8, 1/2, 5/8, 3/4 in. cold chisels; 3/32 and 3/16 in. center punch; 1/8 and 3/16 in. solid punch; 3/32, 1/8, 5/32, 3/16 and 1/4 in. pin punch. Wt. 3.12 lbs.
009-10318 **179.99**

Catalog/Online EXCLUSIVE
V. Mayhew 3-piece Heavy-Duty Brass Punch Set. For aligning unhardened steel or aluminum and non-marring or non-sparking applications. The softer brass will not damage hard surface materials. Includes 3/4 x 10 in. and 3/4 x 14 in. tapered and 3/4 x 12 in. drift punches plus storage pouch. Wt. 4.2 lbs.
009-47409 **79.99**

W. Mayhew 3-piece Brass Drift Punch Set. Designed for aligning unhardened steel or aluminum. Soft brass punches resist marring and sparking, will not damage hard surface materials. With 3/4-inch, 1/2-inch and 3/8-inch punches. Wt. 1.75 lbs.
009-46515 **19.99**

Catalog/Online EXCLUSIVE
X. NEW-SAVE *10 Mayhew® 4-piece Bearing Race Punch Set. Oval tips for bearing race applications. Set includes 7/16 x 6, 1/2 x 10, 9/16 x 14 and 5/8 x 20 in. Wt. 3.8 lbs.
009-10321 **59.99**



heavy-duty punch set

light-duty punch set

X NEW

U NEW

*Warranted, see page 94a.

Catalog/Online EXCLUSIVE

A. SAVE OVER 35% Craftsman 25-piece Professional Screwdriver Set. The most complete set of our professional screwdrivers. Includes all screwdrivers in 009-50479 20-piece set (listed below), plus T25, T27, T30 #2 x 8 in. and scratch awl. Separate prices total \$211.75. Wt. 7.33 lbs.

009-47205139.99
P Personalized 009-50080169.99

Catalog/Online EXCLUSIVE

B. SAVE OVER 35% Craftsman 20-piece Professional Screwdriver Set. A complete set of our best screwdrivers! Includes 11 slotted (1/8 x 3, 3/16 x 4, 3/16 x 6, 3/16 x 6 cabinet, 1/4 x 2 1/4, 1/4 x 4, 1/4 x 6, 1/4 x 8, 5/16 x 6, 5/16 x 8, 3/8 x 8 in.); six Phillips (#0 x 3, #1 x 4, #2 x 2 1/4, #2 x 4, #3 x 6, #4 x 8 in.); and three Torx® (T-10 x 6, T-15 x 6, T-20 x 6 in.). Separate prices total \$174.80. Wt. 5.71 lbs.

009-50479109.99

C. Craftsman 10-piece Professional Screwdriver Set. Six slotted (3/16 x 4, 1/4 x 2 1/4, 1/4 x 4, 1/4 x 8, 5/16 x 6 and 3/8 x 8 in.), four Phillips (#1 x 4, #2 x 2 1/4, #2 x 4 and 3 x 6 in.). Separate prices total \$91.90. Made in USA. Guaranteed Forever!® Wt. 3.25 lbs.

009-4720359.99
P Personalized 009-4722379.99

Also Available

Craftsman 8-piece Professional Screwdriver Set. Includes five slotted (1/4 x 2 1/4, 1/4 x 4, 1/4 x 6, 5/16 x 6, 3/8 x 8 in.) and three Phillips (#1 x 4, #2 x 2 1/4, #2 x 4 in.). Separate prices total \$72.92. Wt. 2.45 lbs.

009-4720249.99

Craftsman 5-piece Professional Screwdriver Set. Includes three slotted (3/16 x 4, 1/4 x 4, 5/16 x 6) and two Phillips (#1 x 4, #2 x 4 in.). Separate prices total \$42.95. Wt. 1.36 lbs.

009-4720129.99



MORE TO EXPLORE
 at sears.com!

P Personalize it!

AVAILABLE IN 25, 20, 10, 8 AND 5-PIECE SETS



P Personalize it!

CRAFTSMAN PROFESSIONAL SCREWDRIVER OPEN STOCK AT SEARS.COM/SHOPTOOLS

P Personalize it!

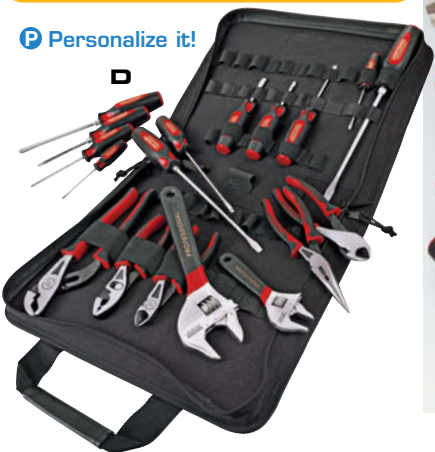

Catalog/Online EXCLUSIVE

D. SAVE OVER *60 Craftsman Professional 18-piece All-Purpose Pro Tool Set in Case. Includes six slotted screwdrivers (1/8 x 3, 3/16 x 4, 1/4 x 2 1/4, 1/4 x 6, 5/16 x 8, 3/16 x 6 cabinet in.); five Phillips screwdrivers (#0 x 3, #1 x 4, #2 x 2 1/4, #2 x 4, #3 x 6 in.); five pliers (8-inch long nose, 6 3/4-inch slip joint, 6-inch diagonal, 8-inch bent wide jaw diagonal, 9 1/2 arc joint); and two beak jaw adjustable wrenches (6, 10 in.). Set comes in portfolio case. Separate prices total \$250.82. Wt. 13.22 lbs.

009-45367199.99
P Personalized 009-50081229.99



P Personalize it!

includes storage



Catalog/Online EXCLUSIVE

E. Craftsman Professional 18-piece Pro Tool Set with Bag. Includes seven slotted screwdrivers (1/8 x 3, 3/16 x 6, 1/4 x 2 1/4, 1/4 x 4, 1/4 x 8, 5/16 x 8 and 3/8 x 8 in.); four Phillips screwdrivers (#0 x 3, #1 x 4, #2 x 4 and #3 x 6 in.); scratch awl, four pliers (6 3/4-inch slip joint, 8-inch long nose, 10 1/2 arc and 8-inch bent wide jaw); two adjustables (8-inch and 10-inch) and a Craftsman tote bag. Separate prices total \$244.82. Wt. 12.5 lbs.

009-50082159.99
P Personalized 009-50083189.99



F NEW

G NEW

Catalog/Online EXCLUSIVE

F. NEW Craftsman 3-piece Pro Slip-Joint Pliers Set. Arc and slip-joint pliers have a flush rivet design for better access to work area. Set includes 6 3/4-inch pro slip-joint, 9-inch arc joint offset long nose and 10 1/2-inch arc joint pliers. Separate prices total \$70.97. Wt. 3.25 lbs.

009-8304259.99

Catalog/Online EXCLUSIVE

G. NEW Craftsman Pro 3-Piece Slip/Solid Joint Pliers Set. Revolutionary design combines traditional solid joint use pliers with slip/arc joint plier flexibility, enabling plier jaws to remain more parallel while grasping various sizes of fasteners. Set includes 8-inch slip joint long nose, 9-inch arc joint offset long nose and 11-inch slip joint long nose. Separate prices total \$89.97. Wt. 3.25 lbs.

009-8304159.99

CRAFTSMAN®

PROFESSIONAL

Catalog/Online EXCLUSIVE

H. SAVE OVER 25% Craftsman Professional 6-piece Professional Pliers Set. Includes: 6-inch diagonal, 8-inch bent wide jaw diagonal, 8-inch long nose, 10 1/2-inch arc joint, 6 3/4-inch slip joint and 9-inch linesman pliers. Separate prices total \$137.94.

Wt. 4.58 lbs.

009-45360109.99

P Personalized 009-45350129.99

Catalog/Online EXCLUSIVE

J. Craftsman Professional 5-piece Pro Pliers Set. Set includes 6-inch diagonal, 8-inch bent wide-jaw diagonal, 8-inch long nose, 10 1/2-inch arc joint and 6 3/4-inch slip joint pliers. Separate prices total \$109.95. Warranted*. Wt. 3.45 lbs.

009-4536189.99



5-piece set

Catalog/Online EXCLUSIVE

K. SAVE OVER 20% Craftsman Professional 15-piece Professional Tool Set with Craftsman Deluxe Soft Storage Bag. Includes five slotted (1/8 x 3, 3/16 x 4, 1/4 x 2 1/4, 1/4 x 8 and 5/16 x 8), five Phillips (#0 x 3, #1 x 4, #2 x 1/4, #2 x 4 and #3 x 6), four pliers (6 3/4 slip, 8-inch long nose, 10 1/2 arc and 6-inch diag.), 8-inch adjustable and a Craftsman tote bag. Separate prices total \$195.84. Wt. 6.7 lbs.

009-50084139.99

P Personalized 009-50085169.99

Catalog/Online EXCLUSIVE

L. SAVE OVER 25% Craftsman Professional 3-piece Beak Jaw™ Adjustable Wrench Set.

Includes 6-, 8- and 10-inch sizes. These wrenches have extra-wide jaw openings to grip and turn larger fasteners in confined spaces. Made of forged alloy steel with corrosion-resistant plating. Textured cushion grips. Spring tension knurls for smooth operation, and inch and metric measuring scales are included for quick, accurate sizing. Separate prices total \$82.97. Made in USA. Guaranteed Forever!® Wt. 2.4 lbs.

009-5047559.99

P Personalized 009-5045579.99

Catalog/Online EXCLUSIVE

M. SAVE OVER 20% Craftsman Professional 3-piece Pro Long Reach Plier Set. Set includes 11-inch duckbill, 11-inch bent long nose and 11-inch long reach nose pliers. Separate prices total \$89.97. Warranted*. Wt. 2.43 lbs.

009-4536469.99



P Personalize it!

George Smith



P Personalize it!



includes storage

CRAFTSMAN PROFESSIONAL PLIERS OPEN STOCK AT SEARS.COM/SHOPTOOLS

- inch and metric measuring scales.
- beak jaw capacity averages 20% greater than our standard adjustable wrench



P Personalize it!

duck bill

bent long nose

long nose

11 inch long reach set

GENERAL PURPOSE TOOLS

*Warranted, see page 94a.

P See page 43 for more information.



A

Catalog/Online EXCLUSIVE

A. Craftsman 11-piece Solid-Joint Pliers Set.

Includes 6-inch long nose, 6-inch bent long nose, 8-inch linesman, 6-inch diagonal cutter, 8-inch duckbill, 8-inch long nose, 8-inch long reach long nose, 7-inch diagonal cutter, 7-inch bent wide jaw cutter, 4-inch diagonal cutter and 4 1/2-inch long nose. Each features a high-leverage design for powerful gripping and cutting. Tough, durable alloy steel, hardened and tempered for long-lasting performance. Comfort-grip handles. Separate prices total \$168.89. Guaranteed Forever!® Wt. 4.9 lbs.

009-45450 119.99

Catalog/Online EXCLUSIVE

B. Craftsman 8-piece Solid-Joint Pliers Set.

Includes 6-inch diagonal cutting, 8-inch long reach, 8-inch duckbill, 7-inch diagonal, 7-inch linesman, 6-inch long nose, 8-inch long nose and 6-inch bent long nose. Each features a high-leverage rivet location for powerful gripping and cutting. Tough, durable alloy steel, hardened and tempered for long-lasting performance. Comfort cushion-grip handles decrease fatigue. Separate prices total \$138.42. Guaranteed Forever!® Wt. 4.12 lbs.

009-50494 99.99

Catalog/Online EXCLUSIVE

C and D. Craftsman Multi-Purpose Pliers Sets.

These Craftsman sets are made of hardened and tempered alloy steel for long-lasting performance. Solid-joint pliers have a high-leverage design for superior cutting, gripping. Arc-joint and slip-joint pliers have flush rivet design for closer access to worksurfaces. Each features comfort-grip handles. Guaranteed Forever!®

C. Craftsman 6-piece Pliers Set. Includes 6-inch diagonal cutting, 8-inch duckbill, 8-inch linesman, 8-inch long nose, 6 3/4-inch slip joint and 9-inch arc joint. Separate prices total \$96.94. Wt. 3.92 lbs.

009-45408 69.99

D. Craftsman 4-piece Pliers Set. For home, shop or auto, includes 7-inch diagonal, 8-inch long nose, 6 3/4-inch slip-joint and 9 1/2-inch arc joint. Separate prices total \$58.96. Wt. 2.44 lbs.

009-45235 39.99

P Personalized 009-50086 59.99

Catalog/Online EXCLUSIVE

E and F. Craftsman Pliers Sets. Flush rivet design allows closer access to worksurfaces and provides improved strength.

E. Craftsman 3-piece Slip-Joint Pliers Set.

Includes 6 3/4, 8 and 10-inch sizes. Wire-cutting edge, three working surfaces plus two jaw openings. Separate prices total \$35.47. Wt. 2.13 lbs.

009-45233 29.99

F. Craftsman 3-piece Arc-Joint Pliers Set.

Includes nine 1/2, 13 and 16 1/2-inch sizes. Separate prices total \$87.47. Wt. 5.93 lbs.

009-45439 69.99

Catalog/Online EXCLUSIVE

G. Craftsman 6-piece Laminated Pliers Set.

Coated, laminated steel offers excellent corrosion resistance to this set, which contains 6-in. diagonal cutter, 6 1/2-in. slip joint and long nose, 8-in. adjustable and slip joint and 10-in. adjustable-joint pliers. Separate prices total \$56.44. Wt. 4.35 lbs.

009-45746 39.99

Also Available

3-piece Laminated Pliers Set. Includes 6 1/2-inch long nose, 6 1/2-inch slip-joint and 8-inch adjustable joint pliers. Wt. 2 lbs.

009-45743 19.99

Catalog/Online EXCLUSIVE

H. RoboGrip® 3-piece Pliers Set. These pliers self-adjust around objects for and incredibly secure, non-slip hold. Spring-loaded for easy one-handed operation.

Set includes 10-inch V-notch jaw, 9-inch V-notch jaw and 7-inch curved jaw. Wt. 2.6 lbs.

009-30015 29.99



B



E. OVER \$35 VALUE



C

CRAFTSMAN®



F. SAVE OVER 15%



D. OVER \$55 VALUE



G



2-piece set and individual pliers available online

H

SOLID, SLIP JOINT & LAMINATED PLIER OPEN STOCK AT SEARS.COM/SHOPTOOLS

Catalog/Online EXCLUSIVE

J. SK® 3-piece Flexible Pliers Set.

Patented design for access in difficult-to-reach areas. Spring-loaded for ease of use. 180-degree flexible handles provide easy operation at any angle. Durable cutting edges precision machined and hardened for extended life. Includes 7-inch linesman combination pliers, 6 1/2-inch diagonal cutter pliers, and 7-inch needle nose pliers. Wt. 2.5 lbs.

009-45189 54.99

Catalog/Online EXCLUSIVE

K. SK® 13-Piece Tri-Pro Screwdriver Set

Extra large, tri-material, co-injection molded handles offer the ultimate in ergonomic design with a soft-grip zone and textured surfaces for maximum torque transmission. Color-coded tip symbols are printed on the top of handles for quick tool identification. Contains 7/32 x 5 in. and 5/32 x 4 in. cabinet slotted, 1/4 x 1, 1/4 x 5, 5/16 x 6, 3/8 x 8, 7/32 x 5 in. keystone slotted, #1 x 4, #2 x 5, #00 x 2.5, #2 x 1 in. and #2 x 6 in. Phillips screwdrivers. Packaged in a storage tray. Limited lifetime warranty.

009-83249 99.99



features 180-degree offset

J

SK
PROFESSIONAL TOOLS



L



M



N



P



**SLOTTED, PHILLIPS & TORX
SCREWDRIVER OPEN STOCK
AT SEARS.COM/SHOPTOOLS**



K



Q



R

**OVERSIZE POWERHOUSE
SCREWDRIVERS**

Catalog/Online EXCLUSIVE
R. Craftsman 15-piece Heavy-Duty Screwdriver Set. This set offers our biggest, most powerful selection of screwdrivers yet. Includes 11 slotted (3/16 x 6, 3/16 x 9, 1/4 x 4, 1/4 x 6, 1/4 x 8, 1/4 x 12, 5/16 x 1 3/4, 5/16 x 8, 5/16 x 6, 3/8 x 8 and 3/8 x 12 in.); four Phillips (#2 x 6, #2 x 8, #3 x 6 and #4 x 8 in.). Separate prices total \$96.95. Wt. 5.2 lbs.
009-5008839.99

Catalog/Online EXCLUSIVE
L. Craftsman 44-piece Heavy-Duty Screwdriver Set. This set offers the right size and style for every project. Includes 19 slotted (3/32 x 1 1/2, 1/8 x 2, 1/8 x 4, 3/16 x 1 1/2 stubby, 3/16 x 4, 3/16 x 4 cabinet, 3/16 x 6, 3/16 x 8 cabinet, 3/16 x 9, 1/4 x 1 1/2, 1/4 x 4, 1/4 x 6, 1/4 x 8, 1/4 x 12, 5/16 x 1 3/4, 5/16 x 6, 5/16 x 8, 3/8 x 8 and 3/8 x 12 in.); ten Phillips (#0 x 1 1/2, #0 x 2 1/2, #1 x 1 1/2 stubby, #1 x 3, #2 x 1 1/2, #2 x 4, #2 x 6, #2 x 8, #3 x 6 and #4 x 8 in.); seven Torx® (T6, T10, T15, T20, T25, T30, T27); two Robertson junior (#1, #2); one Reed Prince; two offset (1/4 x 1/4 in. slotted and #1 x 2 Phillips); one speedriver (3/16 x 6); one scratch awl and one 4-way pocket driver. Separate prices total \$210.56. Wt. 8.5 lbs.
009-5008979.99

Catalog/Online EXCLUSIVE
M. Craftsman 42-piece All Purpose Tool Set. The ideal all-purpose set for home or workshop, this set includes 21 screwdrivers, nine slotted (3/32 x 1 1/2, 1/8 x 2, 1/8 x 4, 3/16 x 4, 1/4 x 1 1/2, 1/4 x 4, 1/4 x 6, 5/16 x 1 3/4, 5/16 x 8 in.); six Phillips (#0 x 1 1/2, #0 x 2 1/2, #1 x 3, #2 x 1 1/2, #2 x 4, #3 x 6 in.); six Torx® (T10, T15, T20, T25, T27, T30); one scratch awl and one 4-way pocket driver. Also includes 6- and 8-inch wrenches; six pliers (6-inch diagonal cut, 6 1/2-inch long nose, 6 3/4-inch slip joint, 7-inch wide jaw, 8-inch slip joint, 9 1/2-inch arc joint); punch and chisel holder with five punch tools (3/8 x 4 1/2 prick, 3/8 x 4 1/2 center, 1/16 x 4 pin, 3/32 x 4 pin, 1/8 x 4 1/2 in. pin); two alignment tools (5/32 x 7, 3/16 x 9 in.); cold chisels (1/2 x 5 3/4, 5/8 x 6, 3/4 x 6 1/2 in.). Separate prices total \$284.88. Wt. 11.75 lbs.
009-50090149.99

Catalog/Online EXCLUSIVE
N. Craftsman 38-piece Screwdriver Set with Bag. Includes 16 slotted (3/32 x 1 1/2, 1/8 x 2, 1/8 x 4, 3/16 x 1 1/2 stubby, 3/16 x 4, 3/16 x 4 cabinet, 3/16 x 6, 3/16 x 8 cabinet, 3/16 x 9, 1/4 x 1 1/2, 1/4 x 4, 1/4 x 6, 1/4 x 8, 1/4 x 12, 5/16 x 6, 3/8 x 8 in.); nine Phillips (#0 x 1 1/2, #0 x 2 1/2, #1 x 1 1/2 stubby, #1 x 3, #2 x 1 1/2, #2 x 4, #2 x 6, #2 x 8, #3 x 6 in.); seven Torx® (T6, T10, T15, T20, T25, T27, T30); two Robertson junior (#1, #2); two offset (1/4 x 1/4 in. slotted and #1 x #2 Phillips); one scratch awl and one 4-way pocket driver. Separate prices total \$173.61. Wt. 7.1 lbs.
009-5008769.99

Catalog/Online EXCLUSIVE
P. Craftsman 24-piece Screwdriver Set. Includes 10 slotted (3/32 x 1 1/2, 1/8 x 4, 3/16 x 4, 3/16 x 4 cabinet tip, 3/16 x 6, 3/16 x 8 cabinet tip, 1/4 x 1 1/2, 1/4 x 4, 1/4 x 6, 5/16 x 8); seven Phillips (#0 x 1 1/2, #0 x 2 1/2, #1 x 3, #2 x 1 1/2, #2 x 4, #2 x 8, #3 x 6 in.); four Torx® (T-10, T-15, T-20 and T-25); two offset (1/4 x 1/4 slotted and #1 x #2 Phillips) and four-way pocket screwdriver. Separate prices total \$97.86. Wt. 4.13 lbs.
009-5048029.99

Catalog/Online EXCLUSIVE
Q. Craftsman 16-piece Screwdriver Set. Includes eight slotted (3/32 x 1 1/2, 1/8 x 4, 3/16 x 4, 3/16 x 1 1/2 stubby, 3/16 x 6, 1/4 x 1 1/2 stubby, 1/4 x 4, 1/4 x 6 in.); eight Phillips (#0 x 1 1/2, #0 x 2 1/2, #1 x 1 1/2 stubby, #1 x 3, #2 x 1 1/2 stubby, #2 x 4, #2 x 6, #3 x 6 in.). Separate prices total \$65.94. Wt. 2.31 lbs.
009-4703719.99

*Warranted, see page 94a.

A thru G. MEGAPRO® Professional Quality Products

MEGAPRO® patented pull-out bit cartridge screwdrivers offer superior performance, award-winning design and outstanding convenience. The patented pull-out bit cartridge organizes and holds bits securely in place, making it easy to select just the bit you need. Professional-quality high carbon steel shaft and a tough TRIAX® nylon-reinforced handle assure lifetime performance against defects in workmanship and quality. The end of the shaft serves as a 1/4" hex nut driver. Other features include the PALM SAVER™ cap, EZ GUIDE™ collar, professional quality 2-inch S2 steel bits and a comfortable, non-slip grip.



A - G. NEW Megapro® Professional Drivers

Key	Item #	Description	Bits Included	Wt. (lbs.)	Price
A	009-90917	15-in-1 Multibit Original Screwdriver	Phillips 0, 1, 2, 3; Square 0, 1, 2, 3; Star 10, 15, 20, 25; Slotted 4, 6	0.56	\$19.99
B	009-90918	15-in-1 Hex Bit Driver	Inch: 3/32, 7/64, 1/8, 9/64, 5/32, 3/16, 7/32, 1/4 Metric: 2, 3, 4, 5, 5.5, 6 mm	0.56	24.99
C	009-90919	14-in-1 Auto/HVAC Driver	Phillips 1, 2; Star 9, 10, 15, 20, 25, 27, 30, 40; Slotted 5.5; Valve Stern; 1/4-in. socket adapter	0.56	24.99
D	009-90900	13-in-1 Ratcheting Screwdriver	Phillips 0, 1, 2, 3; Square 1, 2; Slotted 4, 6; Torx® 10, 15, 20, 25	0.56 0.56	34.99 34.99
E	009-90916	15-in-1 Multibit Tamperproof Screwdriver	Hex Pin 1/8+9/64, 5/32+ 3/16; Spanner 6+8, 10+12; Star Pin 10+15, 20+25, 27+30	0.56	29.99
F	009-90913	15-in-1 ShaftLOK™ Screwdriver	Phillips 0, 1, 2, 3; Square 0, 1, 2, 3; Slotted 4, 6; Torx® 10, 15, 20, 25	0.56 0.56	29.99 29.99
G	009-90914	6-inch ShaftLOK™ Extension	6-inch locking extension for the ShaftLOK™ Tool	0.25	14.99
	009-90915	10-inch ShaftLOK™ Extension	10-inch locking extension for the ShaftLOK™ Tool	0.63	17.99



features locking extension



Catalog/Online EXCLUSIVE
H. NEW Channellock® Pro's Choice 4-piece Pliers Set. Set includes 4 1/2, 6 1/2, 12 and 16-inch tongue and groove pliers. Features and benefits below. Wt. 4.59 lbs.
009-8777179.99

Catalog/Online EXCLUSIVE
J. NEW Channellock® The Rescue Tool. Combining six tools in one, this invaluable tool was introduced for fire and rescue professionals. Weighing only 26 ounces, this tool can cut through battery cables, close gas shut-off valves, wedge open doors and windows, shatter safety glass and more. Wt. 1.63 lbs.
009-8777259.99

Catalog/Online EXCLUSIVE
K. Channellock® 8-piece Tool Set in a Canvas Tool Roll. Set features 6 1/2 and 9 1/2-inch tongue and groove pliers, 7 3/4-inch curved diagonal cutting plier, 8-inch long nose with cutter, 8-inch WideAzz™ adjustable wrench, 9-inch crimping tool, 9-inch oil filter plier, 12-inch brake tool. Wt. 6.9 lbs.
009-52551129.99

Code Blue® pliers by Channellock® combine PermaLock® fasteners with laser-heat-treated cutting edges and teeth. Super-durable bold red and Santoprene™ grips with Code Blue® letter designations, made from high carbon C1080 steel for superior performance, electronic coating for the ultimate rust prevention.

L. Channellock® 5-Piece Code Blue® Tool Set in a Canvas Tool Roll. The set includes: one 9 1/2-inch high leverage linemen's plier, one 10-inch tongue and groove plier, one 8-inch diagonal cutting plier, one 8-inch long nose plier with cutter and one 8-inch WideAzz™ adjustable wrench. Adjustable wrench made in Spain, pliers made in USA. Wt. 4.5 lbs.
009-45336129.99

M. Channellock® 8-Piece Code Blue® Pliers Set in a Canvas Tool Roll. The set includes: one 9 1/2-inch high leverage linemen's plier, one 9 1/2-inch tongue and groove plier, one 10-inch tongue and groove plier, one 8-inch long nose plier with cutter, one 8-inch diagonal cutting plier, one 8-inch end cutting plier, one 9-inch crimping tool and one 9-inch cable-cutting plier. Made in USA. Wt. 6.5 lbs.
009-45337199.99



N. Craftsman Ratcheting Magnetic Screwdriver with Bit Storage. Make quick work of any driving project with this innovative screwdriver. Features ergonomic design with unique six-bit storage system that lets you dial to the bit you want. Knurled, stainless steel shaft allows fast turning and resists corrosion. Includes four Phillips (#0, #1, #2, #3), five slotted (1/8, 5/32, 3/16, 1/4, 5/16 in.), six Torx® (T10, T15, T20, T25, T27, T30), four square drive (#0, #1, #2, #3) and six hex shank (1/8, 3/16, 5/16 in. and #4, #5, #6) single side bits. Includes additional bit holder. Wt. 1 lb.
009-47144 19.99

Catalog/Online EXCLUSIVE
P. Craftsman 24-piece Precision Cushioned Screwdriver Set. Upgraded for even better performance, these screwdrivers feature a cushion grip, with a swivel cap indicating blade size and color-coding to indicate tip style. Right-sized blades for correct fit. Includes nine slotted (1/32 x 1, 3/64 x 1, 1/16 x 1, 5/64 x 1 1/2, 3/32 x 1 1/2, 1/8 x 1 1/2, 1/8 x 2 1/2, 9/64 x 2 1/2, 5/32 x 2 1/2 in.), six Phillips (#0000 x 1, #000 x 1, #00 x 1 1/2, #0 x 1 1/2, #0 x 2 1/2, #1 x 2 1/2 in.), five Torx® (T-5 x 1 1/2, T-6 x 1 1/2, T-7 x 1 1/2, T-8 x 2 1/2, T-9 x 2 1/2 in.) and four ball hex (.05 x 1 1/2, 1/16 x 1 3/4, 5/64 x 2 1/2, 3/32 x 2 3/8 in.). Wt. 1.65 lbs.
009-41711 49.99

Q. Craftsman 7-piece Reversible/Ratcheting Screwdriver Bit Wrench Set. Three configurations for easy access to hard-to-reach applications. Includes two Phillips (#1, #2), two slotted (1/4, 9/32 in.) and three bit wrenches. Made in USA. Wt. 0.56 lb.
009-47477 19.99

>> Check online for SALE PRICING!

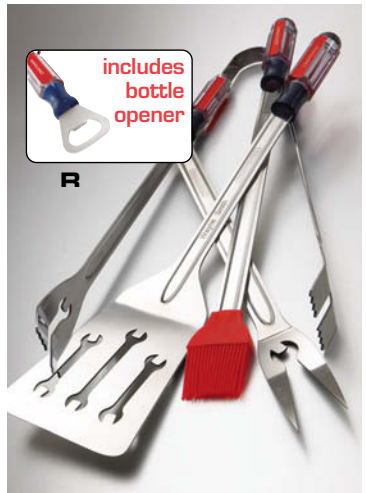

includes bottle opener



features dial-a-bit quick change system

Catalog/Online EXCLUSIVE
R. Craftsman 4-piece Barbecue Gift Set with Bottle Opener. Let Craftsman tools take your next barbecue to a precision level with this collection of cookout tools. Utensils are stainless steel with contoured Craftsman tool-style grips. Set includes BBQ fork, brush, tongs and bottle opener. Wt. 2.38 lbs.
009-41656 29.99

Catalog/Online EXCLUSIVE
S. Craftsman 2-piece Safety Wire Twisting Pliers. A must for aviation, racing and motorcycle maintenance. Forged of high-quality steel, these pliers offer the security of safety wire in the most critical applications. 6-inch pliers are ideal for tight spots. 9-inch pliers feature automatic return for ease of use. Guaranteed Forever!® Wt. 0.64 lb.
009-42280 129.99

T. NEW Craftsman 2-piece Pipe Wrench Pliers Set. 90-degree angled jaws for ease of access and gripping. Cushioned grips provide added comfort. Exclusive handle stop prevents pliers from pinching fingers. 12 3/4-inch pliers have a 2 5/8-inch maximum parallel jaw opening. 10-inch pliers have 2 1/8-inch maximum jaw opening. Seven adjustments on both pliers. Wt. 3.25 lbs.
009-45406 29.99

U. Craftsman 7- and 10-inch Adjustable Pliers. Made from oil-hardened special alloy steel, pliers feature a self-gripping jaw and a time-saving 11-position push-button adjustment mechanism for a precise fit. Locking mechanism retains jaw size until readjusted. 7-inch pliers adjusts 1/8 to 1 1/4 in. and 10-inch pliers adjusts 1/8 to 1 1/2 in. Wt. 1.1 lbs.
009-45433 34.99

V. Leatherman Skeetool™ CX. For the outdoor enthusiast, this tool offers minimal weight, compact size and endless capabilities. Pliers, wire cutters, combination straight/serrated blade, universal bit driver, carabiner/bottle opener. Stainless steel, tungsten coating with carbon fiber handle. Wt. 5 oz.
009-70411 84.99

W. Midwest 3-piece Offset Aviation Snips Set. Offset aviation snips make long cuts easy by flowing material away from blades and keeping user's hand above sheet material. Wt. 3.12 lbs.
009-42890 49.99

Catalog/Online EXCLUSIVE
X & Y. Schroeder Spiral Ratcheting "Yankee" Screwdrivers. Precision crafted in Germany from Schroeder. All feature traditional three-position ratcheting mechanism, forward, neutral, and reverse for fast, easy screw insertion and removal. Fast-change chuck for easy bit insertion and removal. Precision-machined collets and ratcheting mechanisms for long-lasting, smooth operation. Nickel chrome-plated exterior for superior rust resistance. 17 1/2-in. and 11 1/2-in. models feature a durable ergonomic wooden handle for comfort. Driver bits made from hardened, high-strength tool steel. Warranted*.

X. NEW 17 1/2 inch. #2 Phillips; 3/16 and 7/32-in. slotted bits. Wt. 1.13 lbs.
009-83246 59.99

Y. NEW 8 1/2 inch. Bit storage in handle. #1 and #2 Phillips, 1/8, 3/16 and 7/32-in. slotted bits. Wt. 0.63 lb.
009-83248 36.99

Also Available
NEW 11 1/2 inch. #2 Phillips; 3/16 and 7/32-in. slotted bits. Wt. 0.74 lb.
009-83247 44.99



GENERAL PURPOSE TOOLS

*Warranted, see page 94a.
 ◆See "N" suffix note on page 94a.

Y NEW

Catalog/Online EXCLUSIVE

A, B, C & D. Craftsman Adjustable Wrench Sets. Durable heat-treated, forged alloy steel construction. Tapered heads for easy access in tight spots. Precision-broached, steel construction and hardened extra-wide steel jaws. Comfortable balanced design. Spring tension knurl for smoother operation. Made in USA. Guaranteed Forever!*

A. Craftsman 3-piece Giant Size Wrench Set with Industrial-Quality Black Oxide Finish. Tough black oxide finish helps chipping, flacking, resists rust and corrosion. Includes 12- and 15-inch sizes plus a huge 18-inch wrench. Separate prices total \$140.97. Wt. 9.13 lbs.

009-44652 109.99

B. Craftsman 3-piece Giant Size Nickel-Plated Wrench Set. Tough nickel-plated coating resists corrosion, minimizes wear and abrasion. Includes 12 and 15-inch sizes plus a huge 18-inch size. Separate prices total \$140.97. Wt. 9.13 lbs.

009-44916 109.99

C and D. Craftsman 4-piece Adjustable Wrench Sets. Includes 6, 8, 10 and 12-inch sizes to handle most home repairs. Made in USA. Guaranteed Forever!*. Wt. 2.97 lbs.

C. 009-42845 Nickel-Plated 59.99

D. 009-44670 Black Oxide 59.99

Also Available

Craftsman 3-piece Nickel-Plated Wrench Set. Includes 8, 10 and 12-inch. Separate prices total \$59.97. Wt. 2.77 lbs.

009-44665 49.99

Craftsman 3-piece Wrench Set with Industrial-Quality Black Oxide Finish. Includes 8, 10 and 12-inch wrenches. Separate prices total \$63.97. Wt. 2.77 lbs.

009-44061 49.99

Catalog/Online EXCLUSIVE

E. SAVE 20% Craftsman Professional 6-piece Easy-Release Locking Pliers Set. Pliers lock easily with just one hand. Mechanism releases grip with push of lower handle. Eliminates need for guarded release lever. Adjustment screw controls gripping pressure. High-grade treated alloy steel construction. Includes 5, 7, 10-inch curved jaw; 7, 10-inch straight jaw; 6-inch long nose. Separate prices total \$85.94. Guaranteed Forever!*. Wt. 5.42 lbs.

009-45706 67.99

Catalog/Online EXCLUSIVE

F. SAVE OVER 10% Irwin® Vise-Grip® 10-piece Locking Tool Set. Includes seven pliers (5, 7, 10-inch curved jaw with wire cutter, 10-inch straight jaw, 6 and 9-inch long nose, 12-inch large jaw) and three locking wrenches (7/16-3/4, 5/8-1 1/8, 1/4-9/16 in.). Separate prices total \$128.90. Wt. 8.47 lbs.

009-45635 99.99

Catalog/Online EXCLUSIVE

G. NEW LockJaw™ 9-piece Locking and Pro Groove Pliers Set. The patented locking mechanism allows the jaws to automatically adjust to any size object for simple one-handed operation, making jobs faster and easier. Constructed with rust-resistant durable steel with non-slip grip and easy release. Includes 11-inch and 7-inch C-clamps (both with and without swivel pads), 10 and 6-inch curved pliers, 7-inch needle-nose pliers and 6 1/2 and 9 1/2-inch tongue and groove pliers. Wt. 9.6 lbs.

009-87770 149.99

*Warranted, see page 94a.



B nickel

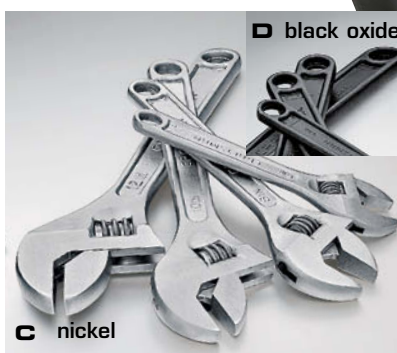

E. OVER \$80 VALUE



G NEW

CRAFTSMAN®

13 locking-180 degree flex head positions make for a pry bar with greater access and leverage!

ED'S PICK

H NEW

available separately online

Catalog/Online EXCLUSIVE

H. NEW-SAVE *22 Craftsman 3-piece Locking Flex Pry Bar Set. Select the angle to get the leverage you need. Pivoting head flexes 180 degrees with 13 locking positions. Push button spring-loaded release. Set includes 8-inch, 16-inch and 24-inch bars. Separate prices total \$121.97. Wt. 10.16 lbs.

009-87653 99.97

Also Available

NEW Also Available Separately:
 009-43295 8-Inch. Wt. 1 lb 24.99
 009-43296 16-Inch. Wt. 2 lbs 36.99
 009-43297 24-Inch. Wt. 5 lbs 59.99
 009-87652 33-Inch. Wt. 6.94 lbs 79.99

Catalog/Online EXCLUSIVE

J. Craftsman 5-Piece Scraper Set. With ergonomic handles for a sure and comfortable grip when scraping gaskets, seals and more, this precision sharpened set of 5 includes 1 1/2, 1 1/4, 1, 3/4, and 1/2-inch hardened and tempered alloy steel scrapers, each 11 inches long. Wt. 1.8 lbs.

009-47406 29.99

Catalog/Online EXCLUSIVE

K. NEW GearWrench® 12-Inch Indexing Nail Puller. Adjusts to 14 different angles and 180-degrees to reach between studs, rafters and ceiling joists. Ideal for angled roof work. Fits nail sizes 4D to 10D. Wt. 6.95 lbs.

009-82717 24.99

Catalog/Online EXCLUSIVE

L. Craftsman 5-piece Screwdriver Pry Bar Set. Screwdriver grips and curved ends give you leverage on tough prying and lifting tasks. Bend-resistant bars are hand-forged of quality alloy steel, then hardened and tempered. Ergonomic 5-inch long cellulose acetate handles. Includes blade sizes 1/4 x 8, 3/8 x 12, 3/8 x 17, 1/2 x 25 and 1/2 x 31 in. Made in USA. Warranted*. Wt. 8 lbs.

009-43279 59.99

M. Craftsman Professional 4-Piece Hook and Pick Set. Ergonomically designed handles for a comfortable and secure grip. Set contains scratch awl, 90-degree hook, complex hook and curved hook for a variety of pulling and marking applications. Each blade is heat-treated and tempered the entire length for maximum durability. Wt. 1.38 lbs.

009-47077 29.99

Catalog/Online EXCLUSIVE

N. Craftsman Professional 5-piece Curved-Blade Pry Bar Set. New two-composite patented handle is designed for a more comfortable grip. Features new capped end that allows user to strike tool with a hammer without damaging the handle. Hardened and tempered their entire length for extra durability. Includes blade sizes 3/8 x 12, 3/8 x 17, 1/2 x 25, 3/8 x 10 and 1/2 x 31 in. Warranted*. Wt. 7.75 lbs.

009-47410 59.99





K NEW

GEARWRENCH

locks in 14 positions with a 180-degree radius for maximum reach

MORE TO EXPLORE
at sears.com!



L



M

short reach



N

3-piece set available online

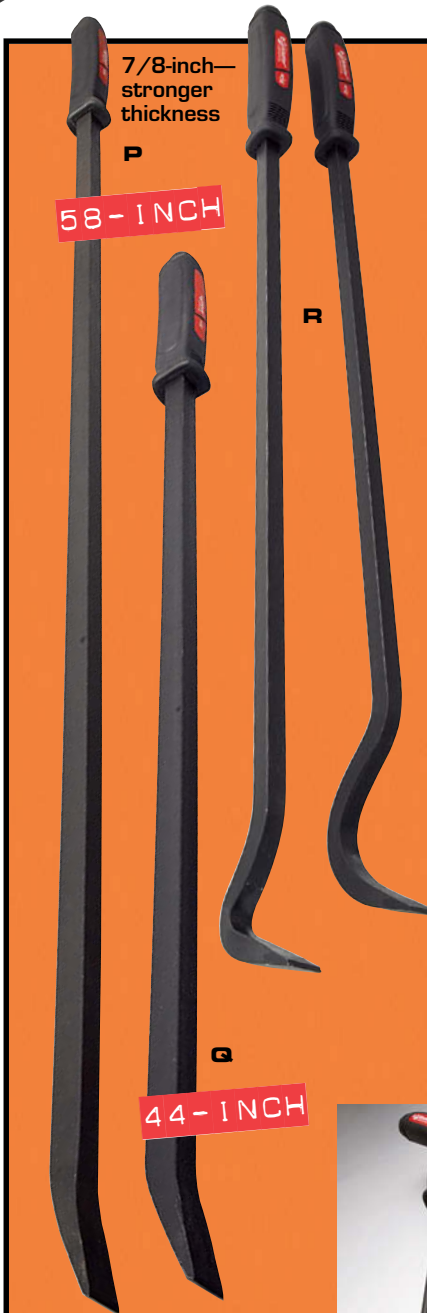

7/8-inch—stronger thickness

P

58-INCH

R

Q

44-INCH

also available, 36-, 42- and 48-in.



Catalog/Online EXCLUSIVE

T. NEW Mayhew Dominator® Heavy-Duty Ripping Chisel. Forged from the highest quality alloy and carbon steel and finished in black oxide to resist corrosion. Shank is heat-treated for maximum strength. Unique steel-capped end allows the user to strike with a hammer without damaging the head. Wt. 4.8 lbs.
009-10320 29.99

U. NEW-SAVE \$20 Mayhew Dominator® Pry Bar Vault. Secure up to four handled pry bars. Mount on wall for security. Made from heavy-duty steel. Measures 14 1/2 x 11 1/2 x 3 1/4 in. Will be \$99.99 in '09 Annual Catalog. Wt. 12.5 lbs.
009-10323 79.99

Catalog/Online EXCLUSIVE

P. Mayhew Dominator® 58-inch Curved Pry Bar. Built to tackle big jobs in tight spaces, with a heat-treated, tempered shaft and an ergonomic handle. Wt. 10.1 lbs.
009-40162 99.99

Also Available

Mayhew Dominator® 36-inch Curved Pry Bar. Wt. 4 lbs.
009-40138 59.99

Mayhew Dominator® 42-inch Curved Pry Bar. Wt. 5.5 lbs.
009-40139 69.99

Mayhew Dominator® 48-inch Curved Pry Bar. Wt. 7.5 lbs.
009-40160 89.99

Catalog/Online EXCLUSIVE

Q. Mayhew Dominator® 44-inch Curved Pry Bar. Thicker and stronger than ever. Crafted with 7/8-inch hardened, tempered steel for maximum durability. Capped end allows user to strike bar without damaging handle. Ergonomic, two composite handle. Wt. 10 lbs.
009-43388 99.99

Catalog/Online EXCLUSIVE

R. Mayhew Dominator® 2-piece Specialty Pry Bar Set. Ideal for tight spaces, pulling seals/pulleys and front-end alignment. Crafted with heat-treated, tempered steel for maximum durability. Capped end allows user to strike bar without damaging handle. Ergonomic, two composite handle. Includes 30-inch Dominator Die Bar and 30-inch Dominator Modified Rolling Headpry bar. Wt. 5 lbs.
009-43389 79.99

Catalog/Online EXCLUSIVE

S. Mayhew Dominator® 6-piece Professional Hook Set. Six unique shapes to fit into tight areas—around wiring, hoses and engine obstacles. Heat-treated and tempered. Ergonomic handle. Includes C-hook (15- and 45-degree hooks, 45-, 60- and 90-degree long hooks). Wt. 2.75 lbs.
009-47407 79.99



long reach

S

T NEW



U NEW

GENERAL PURPOSE TOOLS



A

B NEW



D



bits stored in handle

C NEW



bit fits in various sizes screw-holding hex tool



F

set includes standard and specialty bits for every task



E



G NEW

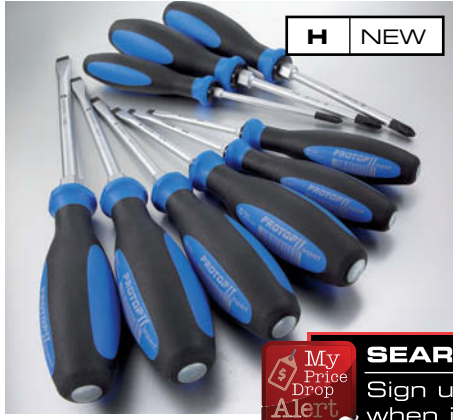

H NEW



J



K



L

Catalog/Online EXCLUSIVE
G. NEW Knipex® & Witte® 24-piece Pliers and Screwdriver Set. Two great brands in one useful set. Sizes include 9-inch high leverage linesman, 8-inch long-nose, 8-inch mini bolt cutter, 8-inch high-leverage diagonal, 7-inch pliers wrench and 10-inch Cobra self-gripping pliers. PROTOP II Plus screwdrivers feature microfiber textured handles and high-alloy steel blades. Sizes include #1 x 3-inch Phillips, #2 x 4-inch Phillips, 1/4 x 4-inch slotted, 3/16 x 6-inch cabinet screwdrivers. Also includes 7-piece slotted/Phillips precision screwdriver set and 7-piece Torx® precision screwdriver set. Wt. 5.45 lbs.
009-87895 379.99

Also Available
NEW Knipex® & Witte® 16-piece Pliers and Screwdriver Set. Sizes include 9-inch high-leverage linesman, 8-inch long nose, 8-inch mini bolt cutter, 8-inch high-leverage diagonal and 10-inch Cobra self-gripping pliers. PROTOP II Plus sizes include #1 x 3-inch Phillips, #2 x 4-inch Phillips, 1/4 x 4-inch slotted, 3/16 x 6-inch cabinet screwdrivers. Also includes 7-piece slotted/Phillips precision screwdriver set. Wt. 4.53 lbs.
009-87894 279.99

H. NEW Witte® 9-piece PROTOP II Impact Screwdriver Set. PROTOP II Impact screwdrivers feature an impact cap that takes an extreme striking force without damage to handle. Set includes sizes 1/8 x 3, 5/32 x 4, 7/32 x 4, 1/4 x 5, 5/16 x 6, 3/8 x 7, #1 x 3, #2 x 4, #3 x 6 in. Wt. 2.55 lbs.
009-87812 139.99

SEARS.COM/SHOPTOOLS
 Sign up to be notified when items go on sale.

Catalog/Online EXCLUSIVES

A. Wiha 24-piece 3/8-Inch 1,000-Volt Rated Insulated Set. Meets ASTM F1505, EN/IEC 60900, NFPA-70E specifications. Includes eleven 12 point inch sockets (1/4, 9/32, 5/16, 11/32, 3/8, 7/16, 1/2, 9/16, 5/8, 11/16, 3/4 in.), two extension bars (5 in. and 10 in.), 3/8-inch drive reversible ratchet, electrician's knife, slotted (9/64, 3/16, 1/4 in.), Phillips (#1, #2, #3), 6.3 in. long-nose pliers, 6.3 in. diagonal cutters and 8 in. combination pliers. Molded storage box. Wt. 9.07 lbs.
009-47306 749.99

Also Available
Wiha 24-piece 3/8-Metric 1,000-Volt Rated Insulated Set. Features eleven 12-point metric sockets (6, 7, 8, 9, 10, 11, 12, 13, 14, 17, 19 mm), two extension bars (5 in., 10 in.), 3/8-in. drive reversible ratchet, electrician's knife, slotted (9/64, 3/16, 1/4 in.), Phillips (#1, #2, #3), 6.3 in. long-nose pliers, 6.3 in. diagonal cutters and 8 in. combination pliers. Molded storage box. Wt. 9.08 lbs.
009-47307 749.99

B. NEW Wiha 13-piece Insulated Slotted & Phillips Screwdriver Set. Each tool individually tested to 10,000 volts & certified to 1,000 volts. Insulation according to IEC 900, ASTM F-1505-01, NEWVDE 0682/part 201, DIN 7437, NFPA70 E. Insulation molded directly onto blade for permanent bonding. Wt. 2.3 lbs.
009-82718 99.99

C. NEW Wiha 8-in-1 Bit Set SoftFinish Cushion Grip Bit Flip Set. Includes slotted bits: 4.5, 6.5 mm; Phillips bits #1, #2; Torx bits: T10, T15, T20, T25. Wt. 0.44 lb.
009-82719 27.99

D. Wiha 39-piece Security 1/4-Inch Bit Set. Features many hard-to-find security bits in one compact case. Includes: eight security Torx® (TR8 to TR40), six security hex (5/64 to 5/32), four spanner (#4, #6, #8, #10), four tri-wing (#1 to #4), three torque set (#6, #8, #10), four Pozi-Drive (#0, #1, #2, #3), three square end (#1, #2, #3), two slotted (1/4, 5/16 in.), two Phillips (#1, #2), one non-slip handle and two adapters. Wt. 1.04 lbs.
009-73645 64.99

E. Wiha Torque Control 51-piece Driver Set with Metal Box. Accurate and economical with cushion-grip handle, tactile/audible rollover/click at achieved torque. Adjustable torque control handle range of 10-50 in.-lbs. with visible display. Includes 48 bits: four slotted (4.5, 5.5, 6.5, 8 mm), four Phillips (#0, #1, #2, #3), eight Torx® (T6 thru T10, T15, T20, T25), eight hex (1/16, 5/64, 3/32, 7/64, 1/8, 9/64, 5/32, 3/16 in.), metric hex (1.5, 2, 2.5, 3, 4, 5, 6, 8 mm), tri-wing (#0, #1, #2, #3, #4), torque set bits (#4, #5, #6, #8), square (#1, #2, #3), and Pozi-Drive (#0, #1, #2, #3). With 1/4 bit holder. Accurate to ±6 percent. Includes certificate. Wt. 2.85 lbs.
009-50481 189.99

F. Wiha 22-piece MagicRing L-Key Hex Inch and Metric Set. The spring steel rotary spring wrapped around the ball end holds screws while you reach into tight work areas. All L-keys are hard chrome finished for rust prevention. Set includes screw-holding inch sizes 1/8, 9/64, 5/32, 3/16, 7/32, 1/4, 5/16, 3/8 in.; metric sizes 3, 4, 5, 6, 8 and 10 mm; and inch ends: .050, 1/16, 5/64, 3/32, 7/64 in. Wt. 2.21 lbs.
009-45152 59.99

Catalog/Online EXCLUSIVE
J. Knipex® 10-piece Industrial High Leverage Insulated Tool Set. Featuring ergonomic dual component handles and heavy-duty tool steel, includes 10-in. diagonal, and alligator, 9 1/2-in. linesman, 8-in. long nose pliers and 6 1/2-in. Cable Shears. 5/32 x 4, 7/32 x 5, 1/4 x 6-in. slotted and 1 x 3 and 2 x 4-in. Phillips and 2 x 4-in. Robertson screwdrivers. Wt. 6.6 lbs.
009-47303 259.99

Also Available
Knipex® 7-piece Commercial High Leverage Insulated Tool Set. Includes 10-in. diagonal, and alligator, 9 1/2-in. linesman, 8-in. long nose pliers, 7/32 x 5-in. slotted, 2 x 4-in. Phillips and 2 x 4-in. Robertson screwdrivers. Wt. 4.4 lbs.
009-47304 199.99

K. Witte® 5-piece Insulated Screwdriver Set. Includes 3-inch, 4-inch and 5-inch flat tips, 3-inch Phillips #1 and 4-inch Phillips #2 screwdrivers. Meets ASTM F1505-01/IEC 900 standards for insulated tools including individual testing up to 1,000 volts. Wt. 1 lb.
009-73628 39.99

Catalog/Online EXCLUSIVE
L. Witte® 7-piece Insulated Precision Screwdriver Set. Ergonomically designed, dual-turning handle with recessed rotating head allows use in various positions. Includes five slotted (.059 x 1.6, .071 x 2.4, .079 x 2.4, .098 x 3 and .118 x 3-in.) and two Phillips (#00 x 1.6, #0 x 2.4 in.). Comes in a lockable storage case. Wt. 0.4 lb.
009-41560 69.99

* Knipex® and Witte® meet ASTM F1505-01 / IEC 60900 standards for insulated tools, including all tools 100% tested to 10,000 volts.

All items on this page are
Catalog/Online EXCLUSIVES

M. NEW KnipeX® 6-piece COBRA® Pliers Set. These unique tools provide instant adjustment, memory retention of jaw opening and single-handed, self-gripping operation with a grip that won't let go. The Cobra is designed to eliminate "knuckle-busting" and the "burring" of nuts, bolts and fittings. Its lightweight and thin profile ensure ease of operation. Set includes sizes 6, 7, 10, 12, 16 and 22-inch pliers. Wt. 11.5 lbs.
009-83989 299.99

N. KnipeX® 3-piece Alligator® Pliers Set. 7, 10 and 12-inch sizes. 7-inch pliers handle up to 1 1/4 inches, 10-inch pliers up to 1 1/2 inches and 12-inch pliers up to 2 inches. Non-slip, self-gripping jaw, seven-position adjustment mechanism and chrome vanadium steel construction. Wt. 2.5 lbs.
009-47250 79.99

P. KnipeX® 4-piece Straight Head Retaining Ring Pliers Set. An innovation in precision and durability, featuring spring steel tips, a large ring contact surface and lightweight, oil-hardened chrome vanadium electric steel. Set includes internal style for ring sizes 1/2 to 1, 3/4 to 2 3/8 in.; external style for ring sizes 3/8 to 1, 3/4 to 2 3/8 in. Pouch included. Wt. 1 lb.
009-47221 79.99

Q. KnipeX® 3-piece Mechanic's Pliers Set. These compact pliers feature two 7/8-inch nose lengths and are crafted with oil-hardened vanadium electric steel and plastic-coated handles. Ideal for automotive applications in confined spaces. Set includes bent, half-round jaw pliers; 45-degree, half-round long jaw pliers; and cranked, half-round pliers. Wt. 1.5 lbs.
009-47302 99.99

R. KnipeX® 4-piece Angled Head Retaining Ring Pliers Set. Designed for precision and strength, these pliers feature a 90-degree angled head, spring steel tips, a large ring contact surface and lightweight, oil-hardened chrome vanadium electric steel. Set includes internal style for ring sizes 1/2 to 1, 3/4 to 2 3/8 inch rings; external style for ring sizes 3/8 to 1, 3/4 to 2 3/8 in. Pouch included. Wt. 1 lb.
009-47220 79.99

S. NEW KnipeX® 4-piece Internal 45-degree Angled Retaining Plier Sets. Solid forged tools feature 45-degree angle for good visibility and accessibility. Sizes include 5 1/2-inch with bore size 5/16 to 1/2-inch, 5 1/2-inch with bore size 1/2 to 1-inch, 7 1/4-inch with bore size 3/4 to 2 3/8-inch, and 9-inch with bore size 3 3/8 to 5 1/2-inch. Wt. 1.17 lbs.
009-87898 79.99

Also Available

NEW KnipeX® 4-piece External 45-degree Angled Retaining Plier Sets. Solid forged tools feature 45-degree angle for good visibility and accessibility. Sizes include 5-inch with bore size 1/8 to 3/4-inch, 5-inch with bore size 3/8 to 1-inch, 6 3/4-inch with bore size 3/4 to 2 3/8-inch, and 8 1/2-inch with bore size 1 9/16 to 4-inch. Wt. 1.12 lbs.
009-87899 79.99

T. NEW KnipeX® 3-piece High Leverage Diagonal Pliers Set. These diagonal cutters require little effort due to perfect coordination of cutting edge angle, leverage ratio and handle shape. Induction-hardened for longer life. Fixed, forged-on axle rivet for durability under heavy use. Made from chrome vanadium electric steel, oil-hardened and tempered. Plastic-clipped handle for comfort. Includes 6 1/4, 8, and 10-inch. Wt. 2.4 lbs.
009-83988 99.99

U. NEW KnipeX® 2-piece Mini-Bolt Cutter Set. Serious cutting power in a compact design. Set includes 8-inch mini-bolt cutter and angled mini bolt cutter. Both are crafted in chrome vanadium steel and can cut through 1/4-inch soft wire, 5/32-inch hard wire and 1/8-inch piano wire. Patented lever action increases cutting force with less effort. Wt. 1.65 lbs.
009-83990 109.99

V. NEW KnipeX® Bolt Cutters. Heavy-duty bolt cutters feature blades made from chrome vanadium steel, oil-hardened and tempered; precision cutting edges; flat head and joint area for access and ergonomically angled handles with non-slip covering. Adjustable 12-position blades for high cutting performance with minimum effort.
009-83994 35 1/4-in. Wt. 11 lbs. 275.99
009-83993 30-in. Wt. 9.45 lbs. 195.99
009-83992 24-in. Wt. 5.71 lbs. 149.99
009-83991 18 1/2-in. Wt. 4.72 lbs. 128.99

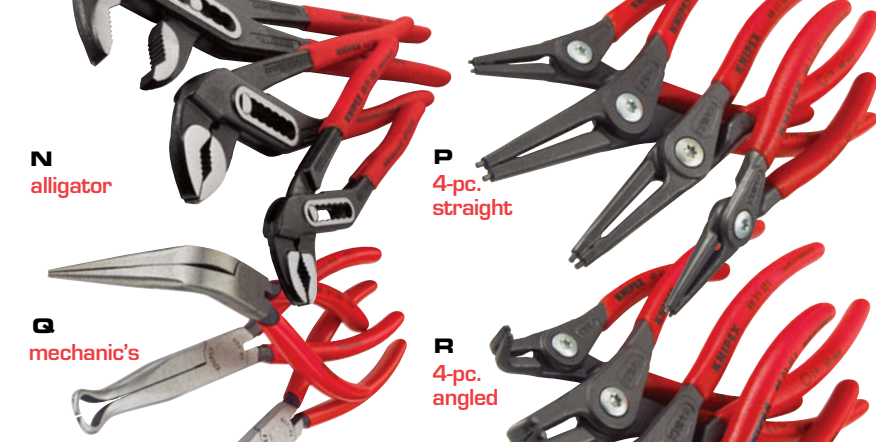

N alligator

P 4-pc. straight

Q mechanic's

R 4-pc. angled

KnipeX is Europe's #1 maker of high-quality pliers. Their ergonomic design reduces fatigue!

ED'S PICK



S NEW

T NEW

U NEW

V NEW

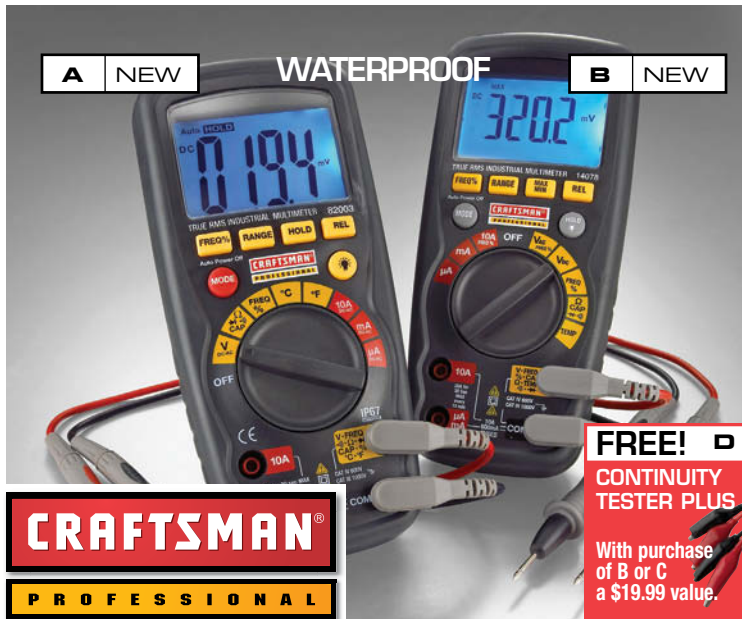

A NEW

WATERPROOF

B NEW



C NEW

C & E include accessories

E

C has built-in IR laser thermometer

FREE! **D**
CONTINUITY TESTER PLUS

With purchase of B or C a \$19.99 value.



A. NEW Craftsman Professional True RMS Multimeter. Waterproof, dustproof, drop-proof to 6 ft. Measure voltage, current, resistance, temperature and more. 1,000V input protection. Molded housing, large backlit display. 0.5% accuracy, Magnetic hanging strip, test leads, type K temperature probe. 9V battery (not included). Auto off. Warranted*. UL listed. Cat IV - 600V. IP67 rated. Wt. 1.5 lbs. **034-82003** **89.99**

Catalog/Online EXCLUSIVE

B. NEW Craftsman Professional Water/ Dustproof True RMS Multimeter. Drop-proof to 6 feet, this durable multimeter measures AC/DC voltage, current, resistance, temperature, capacitance, frequency, duty cycle, diode and continuity. Min/max/relative/data hold functions and auto off. 0.09% accuracy. Includes test leads, thermocouple, magnetic strap and case. **FREE Continuity Tester Plus with the purchase of this meter** - details above. Warranted*. UL listed. Cat IV - 600V. IP67 rated. Warranted*. Wt. 2.5 lbs. **034-90272** **169.99**

Catalog/Online EXCLUSIVE

C. NEW Craftsman Professional True RMS AC/DC Clamp Ammeter with Infrared Thermometer. Clamp meter measures up to 1,000 amps AC/DC. Features built-in non-contact infrared thermometer with laser pointer. 8-to-1 distance-to-spot ratio. Measures up to 518°F (270°C). Min/Max/Peak 1% accuracy. Uses 9V battery, not included. Includes test leads, temperature probe and belt holster. **FREE Continuity Tester Plus with the purchase of this meter** - details above. UL listed. Warranted*. Wt. 1 lb. **034-90273** **179.99**

D. Craftsman Continuity Tester Plus. Two-part system allows you to identify and label both ends of wire or cable in only one trip. High-intensity flashing green or red LED's with a loud audible signal indicate proper identification or wiring reversal. Includes remote probe and pouch case. 9V battery (not included). UL listed. Warranted*. Wt. 1 lb. **034-82148** **19.99**

E. Craftsman True RMS AC/DC Clamp Meter. Measures AC/DC current up to 800A without opening up the circuit. Fast Peak Hold to capture inrush currents. Double-molded housing for durable use. Also measures voltage, resistance, capacitance frequency and temperature. Uses 9V battery (not included). Includes test leads, temperature probe and belt holster. Warranted*. UL listed. Cat III - 600V. Wt. 1.5 lbs. **034-73756** **109.99**

F. Craftsman True RMS Multimeter. Professional grade without the high cost, this meter offers 0.3% accuracy. Large, easy-to-read backlit LCD display, with input fuse protection and misconnection warnings. Uses 9V battery (not included). Complete with test leads and protective rubber boot. Warranted*. UL listed. Cat III - 600V. Wt. 1 lb. **009-81077** **59.99**

G. Craftsman Laser-Directed Non-Contact Infrared Thermometer. Measures surface temp from -58°F to 518°F (-50°C to 270°C) with 2.5 percent accuracy. One-button operation with built-in laser pointer to track aim. Measuring ratio 1:6 target to distance. Accurate to 6 feet. Includes wrist strap. Uses two AAA batteries (not included). 3 5/8" x 2" x 1" D in. Imported. Warranted*. Wt. 0.27 lb. **034-82327** **49.99**

Catalog/Online EXCLUSIVE

H. ElectricCalc® Pro Electrical Code Calculator. A complete electrical reference tool to calculate wire sizes, integrated voltage drop, conduit sizing, motor full-load amps, fuse and breaker sizes. Compliant with 2008, '05, '02, '99 and '96 NEC®. Update to future code revisions with an easy-to-install kit. Includes protective case. Wt. 1 lb. **034-14076** **99.99**

J. NEW Craftsman Test Instrument Kit. Includes full-featured Auto Ranging Multimeter; a non-contact laser-directed infrared thermometer that measures temperatures from -58°F to 1000°F (-50°C to 537°C); a clamp adaptor measures high AC current (for use with the multimeter); and a non-contact voltage tester that detects the presence of AC voltage without contact. Separate prices total \$149.96. Warranted*. UL listed. Wt. 2.8 lbs. **034-82004** **99.99**



J NEW



K NEW

Catalog/Online EXCLUSIVE

K. NEW Extech Home Inspector Kit. All the basics professional inspectors rely on, this kit features moisture meter, infrared thermometer, GFI receptacle tester and stem thermometer. Includes batteries and case. Warranted*. Wt. 2 lbs. **034-99992** **199.99**



Catalog/Online EXCLUSIVE

L. NEW Fluke 113 True RMS Utility Multimeter. Quickly and easily do basic meter set and reconnect testing. Simple-to-use, the Fluke 113 uses the Fluke VCHEK™ LoZ low-impedance measurement function to simultaneously test for voltage or continuity. Can perform diode tests, and also provides both auto- and manual-ranging capabilities. Features include conformance to the latest safety standards, backlight, and a larger display. Wt. 1.34 lbs.
034-90267 **119.99**

Catalog/Online EXCLUSIVE

M. NEW Fluke 88V Automotive Multimeter. Designed for the automotive professional, this cutting-edge multimeter features all the measurement capabilities to solve virtually any problem on conventional and hybrid vehicles. Powerful automotive multimeter offers all standard multimeter features like measuring voltage, current, continuity and resistance, plus the 88V can perform diode test and pulse width measurements. feet. Wt. 1.375 lbs.
034-70732 **419.99**

Catalog/Online EXCLUSIVE

N. NEW Fluke 411D Laser Distance Meter. Professional-grade, fast, easy to use, and fits on your tool belt. Lets you save time and money by reducing measurement time and errors. Quickly determine the distance to your target, the area bounded by two distances, or the volume within three measurements. Includes quick start guide, CD manual, nylon case and 2 AAA batteries. Accuracy to 1/16-in. at 100 Wt. 0.585 lb.
034-90298 **109.99**



SEARS.COM/SHOPTOOLS
Sign up to be notified when items go on sale.

ELECTRICAL

N NEW

P

Q

R

S

T

U



Fluke Meters

Item /Description	P. Fluke 115	Q. Fluke 116	R. Fluke 117	S. Fluke 179	T. Fluke 87-V	U. Fluke 289
Item Number	034-81341	034-59000	034-81377	034-81390	034-70028	034-70734
True RMS Readings	AC	AC	AC	AC	AC	AC/DC
Basic DC Accuracy	0.50%	0.50%	0.50%	0.09%	0.05%	0.025%
Voltage AC/DC	600 V	600 V	600 V	1,000 V	1,000 V	1,000 V
Resistance	40 M Ohm	40 M Ohm	40 M Ohm	50 M Ohm	50 M Ohm	500 M Ohm
Frequency	50 kHz	50 kHz	50 kHz	100 kHz	200 MHz	1 MHz
Capacitance	10 mF	10 mF	10 mF	10 mF	10 mF	100 mF
Temperature (Degrees C)		+400		+400	+1,090	+1,350
Continuity w/Beeper	yes	yes	yes	yes	yes	yes
Diode Test	yes	yes	yes	yes	yes	yes
Motor Drive Low Pass Filter					yes	yes
LoZ: Low Input Impedance		yes	yes			yes
Analog Bar Graph	yes	yes	yes	yes	yes	Trend Capture
Backlight	yes	yes	yes	yes	yes	yes
Min/Max recording	yes	yes	yes	yes	yes	yes
Data Logging						yes
CAT III	600 V	600 V	600 V	1,000 V	1,000 V	1,000 V
CAT IV				600 V	600 V	600 V
Wt.	1.34 lbs.	1.34 lbs.	1.34 lbs.	0.77 lb.	0.78 lb.	4.9 lbs.
Price	\$149.99	169.99	179.99	257.99	369.99	544.99

Catalog/Online EXCLUSIVE

V. Fluke 337 Clamp Meter. Top-of-the-line true RMS clamp meter measures AC/DC current to 999.9A and voltage to 600V, ohms, motor start-up current, frequency, min/max, capability and large backlit display. Small body and jaws fit into tight places. Display hold button keeps measurements on the display. Auto shut-off maximizes battery life. Warranted*. Wt. 1.45 lbs.
034-14082 **368.99**

Also Available

Fluke 322 Clamp Meter. Measures AC/DC current to 400A. Wt. 1.2 lbs.
034-81326 **111.99**

Catalog/Online EXCLUSIVE

W. Fluke T5-1000 Voltage Tester. Automatically measures AC/DC volts with precise digital resolution. Displays voltage to 1,000V. Easy and accurate OpenJaw™ current measurement up to 100A. Compact design with neat probe storage. Rugged enough to withstand a 10-foot (3m) drop. Detachable SlimReach™ probe tips. Auto-off mode. Wt. 0.8 lb.
034-14084 **130.99**



*Warranted, see page 94a.

CRAFTSMAN®

A. NEW Craftsman Professional Handheld 60 LED Worklight. Illuminate the darkest workspace with this heavy-duty light featuring a polycarbonate lens and body. Includes 60 bright LEDs, instant on switch, swivel top hook and 15-foot 18-gauge cord. Wt. 2.2 lbs. **034-73903** **27.99**

B. NEW Craftsman Professional Handheld 35 LED Rechargeable Worklight. Flexible design lets you plug this light in or run for up to 7 1/2 hours on one charge. Durable light features a polycarbonate lens and body, 35 bright LEDs, swivel-top hook and 6-foot, 24-gauge cord. Comes with AC and DC chargers. Wt. 1.6 lbs. **034-73904** **33.99**

C. Craftsman Professional Cord Reel with 26-watt Fluorescent Worklight. Reel mounts on wall or ceiling. Features a circuit breaker protected retractable reel with 30-foot 14/3 triple-tap extension cord. 26-watt worklight has dual switches for use of one or both lamps. Additional tool tap in worklight handle. UL listed. Wt. 10 lbs. **034-73944** **69.99**

SHOP ON THE GO!
Visit sears2go.com on your mobile device



B NEW

A NEW

J

K

Catalog/Online EXCLUSIVE

J. Craftsman Professional 4-piece Coaxial/Romex® Wire Stripper Set. Includes coaxial cable cutter/stripper, Romex stripper/cutter pliers and 10-20 and 20-32 AWG (American Wire Gauge) wire strippers. Wt. 2 lbs.

009-73589 **49.99**

K. Craftsman Professional Wire Stripper. Good for stripping solid or stranded 10-18 AWG wire. Features highly visible graphics, comfortable Santoprene™ grip, push pads, tool lock and hardened steel bolt cutter for #6 and #8 bolts. Made in USA. Wt. 0.28 lb.

009-73653 **19.99**

Catalog/Online EXCLUSIVE

L. Jameson Glow-in-Dark Sectional Fiberglass Push Rods. Solid fiberglass sectional push rods. The perfect non-conductive solution for pushing or pulling wire or cable. Luminescent fiberglass rods can be seen in the dark. Threaded sections let you customize length.

1/4-inch Diameter x 3 Sections of 4-ft. Length. Wt. 1.5 lbs. **009-47278** **39.99**

3/16-inch Diameter x 4 Sections of 5-ft. Length. Wt. 1.5 lbs. **009-47275** **54.99**

3/16-inch Diameter x 7 Sections of 18-in. Length. Wt. 1.3 lbs. **009-47279** **49.99**

Catalog/Online EXCLUSIVE

M. Jameson Knife, Scissors and Snip Grip in Pouch. A telecom industry standard. Ideal for most phone and electrical wire cutting, the Snip Grip handle increases cutting leverage, thus reducing fatigue. With durable PVC pouch. Warranted*. Wt. 1.5 lbs.

009-73737 **39.99**

Catalog/Online EXCLUSIVE

N. Jameson Portable Fluorescent Worklight with 50-foot Cord. Features high-frequency electronic ballast to provide flicker-free light. Shatterproof protective tube shield rugged enough to pound a 16 penny nail into a 2 x 4.

13 watts. Wt. 5.1 lbs. **034-73733** **99.99**

24 watts. Wt. 5.9 lbs. **034-73734** **134.99**

50 watts. Wt. 6.8 lbs. **034-73735** **149.99**

034-73735 **149.99**

Catalog/Online EXCLUSIVE

P. Jameson Fiberglass Fish Tapes. For inside or outside wiring jobs, these durable, lightweight fish tapes feature a tight bending radius and min. 200 lbs. pull strength.

Non-conductive, round fiberglass tapes reduce shock hazard and are easier to push and pull than metal tapes.

1/8-inch x 50-foot Fish Tape. For 1/2 to 1 1/2-in. conduit. Wt. 2 lbs. **009-47276** **49.99**

1/8-inch x 100-foot Fish Tape. For 1/2 to 1 1/2-in. conduit. Wt. 2.3 lbs. **009-47277** **84.99**

009-47277 **84.99**



D. Streamlight Stinger LED Flashlight. Compact and powerful with three variable lighting modes, including strobe. Three-watt Luxeon-LED is impervious to shock with a 20,000-hour lifetime. Constructed of machined aircraft aluminum with non-slip rubberized comfort grip with anti-roll rubber ring. Includes flashlight with two steady chargers and two charge cords (AC 120V, DC 12V). Wt. 0.78 lb. **034-14100** **154.99**

E. Streamlight 3 AA LED Headlamp. Bright, 1-watt super high-flux Luxeon LED has a 50,000-hour lifetime — never needs replacement. 90-degree tilting head lets user direct the light where needed. Longer run time than a traditional xenon bulb. Water-resistant. Can be worn on the head or hardhat. Wt. 0.44 lb. **034-14101** **59.99**

F. Streamlight Junior Luxeon Reach LED Light. Super-bright, powerful light goes anywhere. Twist and turn the tough PVC-coated cable into any position to see almost anywhere. The magnetic clip allows you to attach the light to any metal surface to illuminate your work area. 50,000-hour high-flux LED provides 31 lumens. 20-in. long. Includes 2 AA alkaline batteries and aircraft aluminum case. Wt. 0.39 lb. **034-14072** **52.99**



G NEW

H NEW

G. NEW Snap-on® Rechargeable Security Series Flashlight. Heavy-duty defines this tough light. Features corrosion-resistant, rubber-coated aluminum body with a shatter-resistant lens. High-output LED delivers 100 lumens in standard, and 130 lumens in boost mode. Also features strobe mode. Water-resistant. Rotating collar protects charging port. Includes batteries, charger and belt loop. Wt. 2 lbs. **034-87723** **99.99**

H. NEW Snap-on® Rechargeable Tactical Series Flashlight. Bright and durable, this light features a corrosion-resistant, rubber-coated aluminum body with a shatter-resistant lens. LED delivers 150 lumens in standard, 200 lumens in boost mode, also offers a strobe mode. Water-resistant. Rotating collar protects charging port. Includes lithium-ion batteries, charger and holster. Wt. 1 lb. **034-87725** **89.99**



M

JAMESON

N

P



L

glow-in-the-dark push rods

Catalog/Online EXCLUSIVES

Q. Rothenberger Heavy-Duty Aluminum-Handle Pipe Wrenches. Handles are lighter than comparable cast iron models. Easier to use for longer periods.

Size, inches	Capacity, inches	Catalog Number	Wt., lbs.	Price each
10	1 1/2	009-51645	1.13	\$37.99
14	2	009-51646	2.19	47.99
18	2 1/2	009-51647	3.63	63.99
24	3	009-51648	5.56	93.99
36	5	009-55614	11.13	163.99
48	6	009-55615	19.63	329.99

R. Rothenberger Aluminum-Handle 90-Degree Offset Pipe Wrenches. Easy entry into tight spots. Jaw opens parallel to handle and narrowed hook-jaw head.

Size, inches	Capacity, inches	Catalog Number	Wt., lbs.	Price each
14	2	009-51641	2.25	\$60.99
18	2 1/2	009-51642	3.25	84.99

S. Rothenberger Cast Iron Heavy-Duty Pipe Wrenches. Handles high torque with tensile strength from ductile-type cast steel. Dual heat-treated jaws and machined-sharp teeth.

Size, inches	Capacity, inches	Catalog Number	Wt., lbs.	Price each
10	1 1/2	009-30841	1.81	\$21.99
14	2	009-30842	3.45	31.99
18	2 1/2	009-30843	5.78	41.99
24	3	009-30844	9.18	72.99
36	5	009-55612	19.50	159.99
48	6	009-55613	36.75	279.99

T. Rothenberger Speed Wrench Wrenches.

Ideal for projects where speed is a must, these chrome-plated, chrome vanadium steel wrenches are one-hand actuated. Wrenches feature instant self-locking action and reversing jaws.

Size, inches	Capacity, inches	Catalog Number	Wt., lbs.	Price each
6	up 1/2 OD	009-51683	0.23	\$15.99
8	up 7/8 OD	009-51684	0.48	18.99
10	up 1 1/4 OD	009-51685	0.80	20.99
12	up 1 1/2 OD	009-51686	1.36	31.99

Rothenberger cutters

Innovative designs feature ball-bearing construction for fast, accurate cuts on copper, brass and aluminum tubing.

Key/Description	Max. OD	Catalog Number	Wt., lbs.	Price each
U. Telescopic Tube Cutter	1 3/8	009-51691	0.97	\$33.99

Also Available

Telescopic Tube Cutter	1 5/8	009-51692	1.2	45.99
V. Quick-Release Tubing Cutter	5	009-51693	3.5	144.99
W. Mini Tubing Cutter	1 1/8	009-51284	0.63	20.99
X. Quick-Release Tubing Cutter	2 5/8	009-52144	2.38	85.99



Catalog/Online EXCLUSIVE

Y. Rothenberger 9-piece Plumber's Repair Kit. All the tools you need for a typical repair job in a sturdy carrying case. Thread, grip and cut 1/2 through 1-inch pipe. Includes enclosed ratchet drop-head threader with two-piece handle, three drop-die heads (1/2, 3/4, 1 inch), 14-inch heavy-duty pipe wrench, 1/8 to 1 1/4-inch steel pipe cutter, and 10-inch plumber's pliers. Wt. 17.8 lbs.

009-52137 312.99

Catalog/Online EXCLUSIVE

Z. Rothenberger Enclosed Ratchet Hand Threader Kits. Enclosed ratchet system keeps chips out for smooth, easy threading. Long guides center pipe perfectly. Heads interchange instantly. Reversible dies allow for close-to-wall threading. Sets include die heads, ratchet with two-piece handle and case.

1/2, 3/4 and 1-inch Threader Set. Wt. 15 lbs. 009-30848 209.99

1/2, 3/4, 1 and 1 1/4-inch Threader Set. Wt. 8 lbs. 009-52143 294.99

1/2, 3/4, 1, 1 1/4, 1 1/2 and 2-inch Threader Set. Wt. 20 lbs. 009-30849 599.99

Catalog/Online EXCLUSIVE

AA. Rothenberger Compact 1/2 to 2-inch Threading Machine. Durable machine features automatic thread-cutting stop and through-the-head oiling. Powerful 1 1/2-hp motor cuts pipe and conduit easily. Accepts RIDGID-compatible threading dies. Includes 26 in. legs. Wt. 97 lbs.

009-30845 2,999.99

Also Available

1/2 to 3/4-inch Dies. Wt. 1 lb. 009-30846 79.99

1 to 2-inch Dies. Wt. 1 lb. 009-30847 79.99

Pipe Stand. 1/2 to 8-inch diameter, 2,000 lbs. capacity. Wt. 25 lbs. 009-30850 64.99

Catalog/Online EXCLUSIVE

BB. Speedway® 6500 Series 3/4-hp Drain Cleaning Machine. Thermal-protected motor with in-line GFI. Three-position tilt-away power feed for quick drum changing. Ideal for up to 10-inch lines for floor drains and root blockages. Warranted*. Wt. 215 lbs. 009-51303N 1,899.99

Also Available

Replacement Cables. 3/4 in. x 100 ft. for "BB". Wt. 110 lbs. 009-55481 314.99

Speedway® 4500 Series 1/2-hp Drain Cleaning Machine. Thermal-protected motor with in-line GFI. Three-position power feed: forward, reverse, neutral. Rugged rotational molded drum. Extra-large wheels. Easy-Lube drive shaft. Cleans up to 4-inch lines for sinks, floor drains and roof stacks. Warranted*. Wt. 87 lbs. 009-51304 1,049.99

Replacement Cable. 1/2 in. x 100 ft. for 4500 Series. Wt. 37 lbs. 009-55439 209.99

009-55439 209.99

009-55439 209.99

009-55439 209.99

009-55439 209.99

Catalog/Online EXCLUSIVE

CC. Speedway® 400 Series 1/3-hp Drain Cleaning Machine. Durable motor with in-line GFI. Three-position switch: forward, off and reverse. Rugged rotational molded cable drum with drain hole for easy cleaning. Warranted*. Wt. 51 lbs. 009-51305 419.99



Also Available
Replacement Cable. 3/8 in. x 75 ft. for "CC". Wt. 24 lbs. 009-55436 104.99

ROTHENBERGER



*Warranted, see page 94a.
◆ See "N" suffix note on page 94a.



A NEW



Catalog/Online EXCLUSIVE

A. NEW Spectra Precision® HV101-4 Automatic Self-Leveling Laser. Capable of handling a wide variety of horizontal, vertical and plumb applications, this rugged tool is designed to survive a 3-foot drop onto concrete. Created for ease-of-use, this unit offers fast setups and minimal training. Beam is easily visible even in brightly lit conditions. Split beam enables plumb point transfer and 90-degree layout. Remote control offers scanning, speed control, slope setting, and alignment control for fast one-person setups included HR150 laser receiver for use in outside leveling applications. Enables user to electronically locate the beam in bright sunlight. Water-resistant. 3-year instant over-the-counter exchange warranty eliminates downtime. Wt. 12.8 lbs. ●

009-82949 699.99

Catalog/Online EXCLUSIVE

B. NEW Spectra LL100-2 Self-Leveling Laser Tool. One-Man Leveling Laser in a case. Capable of handling leveling applications such as footings, foundations, slabs and any other type of level applications. The self-leveling rotating laser with HR320 receiver, grade rod (inches or tenths) will reduce the time needed to set elevations and do with just one person. Also capable of setting single slope grades. Warranted.* Wt. 30 lbs. ●

009-82944 649.99

Catalog/Online EXCLUSIVE

C. Craftsman Professional Green Rotary Level with Remote Control, Long Distance Detector. Green laser technology is 400% brighter than red and visible in the daylight. Featuring 360-degree rotation, plumb dot with up to 200-foot range and battery charge indicator. Control rotation speed, line segment, on/off modes with remote. Includes level, hard case, ceiling/wall mount, remote, detector, glasses and BONUS rod. Will be \$249.99 in '09 Annual Catalog. Wt. 19.8 lbs. ●

009-48297 249.99

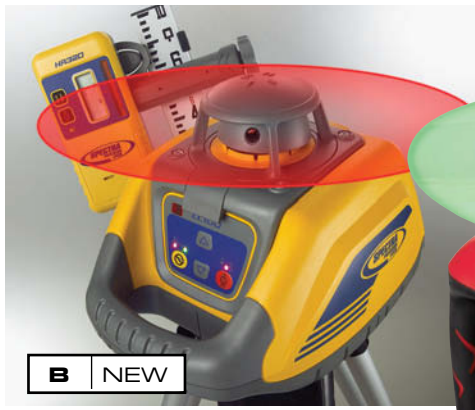

B NEW

Catalog/Online EXCLUSIVE

D. Craftsman LaserTrac™ 360-Degree Rotary Laser Level. Two-beam leveling tool rotates laser diodes 360 degrees. Projects the appearance of a horizontal (or vertical) line with plumb point. LED backlit vials for use in poor lighting. Accurate to ±1/4 inch even 100 feet away. Features three rotation speeds and three line segment distances. Mount to any 1/2-inch or 5/8-inch tripod. Includes carry case, long-distance target, laser-enhancing glasses and user guide. Class IIIa. Wt. 3.31 lbs. ●

009-48249 129.99

Catalog/Online EXCLUSIVE

E. CST/Berger Cross-Line Green Beam Self-Leveling Laser Level. Projects bright green level and plumb laser chalk lines for instant and accurate reference marks. Accuracy of 3/32 in. at 100 feet with an indoor working range of up to 100 feet. Diode strength of 532Nm (Class 2M) is four times brighter than any red beam laser. Includes laser, magnetic mini-laser tripod, 3 "AA" batteries, manual and case. Wt. 2 lbs. ●

009-48051 329.99

Catalog/Online EXCLUSIVE

F. NEW Sola® Floor Cross Line Laser with Carry Bag. Tile an entire room without moving the laser! Set up to three tiles simultaneously with the exclusive front/rear crosshairs. Feet adjust up to 2 inches for self-leveling and to clear tile heights. Accurate to 0.3mm/m (lateral) or 0.017 degrees. Range is 11+ yards. Two AA batteries (not included). Wt. 0.44 lb. ●

009-87857 299.99



F NEW

Catalog/Online EXCLUSIVE

G. Spectra Precision HD50 Professional Distance Measuring Tool. This compact unit is ideal for use by one person on difficult-to-reach or hazardous sites. The visible, non-contact distance-measuring laser is accurate to 1/16 inch up to 165 feet. Features area, volume and continuous measurement keys and intuitive user keypad. Includes four AAA batteries, belt pouch and rugged padded case. Auto off after 5 min. Warranted*. Wt. 0.3 lb. ●

009-48393 169.99



C

SHOP ON THE GO!
Visit sears2go.com on your mobile device

Catalog/Online EXCLUSIVE

H. NEW Craftsman Laser Measuring Tool and 10-inch Digital Level Combo. The Measuring Tool features an easy-to-read LCD screen to display measurements in fractions of an inch, decimals, centimeters or millimeters. Accurate to ± 3/16-in. and calculates cubic, square, Pythagorean, and segment measuring. The Digital Level has an easy-to-read LCD screen and features memory recall, conversion buttons (inch/foot, percent of grade and degree) and an accuracy of ± 0.1 degrees. Wt. 1.7 lbs. ●

009-79582 129.99

Also Available

- 10-inch Laser Level.** Wt. 1.2 lbs. ● 49.99
- 24-inch Laser Level.** Wt. 2.5 lbs. ● 69.99
- 48-inch Laser Level.** Wt. 3 lbs. ● 79.99

J. Craftsman Digital Torpedo Level with LaserTrac™. Takes the guesswork out of reading or calculating angles, grades and plumb. Large back-lit LCD digital screen. Audible tone every 45 degrees. With manual and carrying case. Uses 2 AAA batteries, included. Wt. 0.8 lb. ●

009-48295 34.99

H NEW



D



G

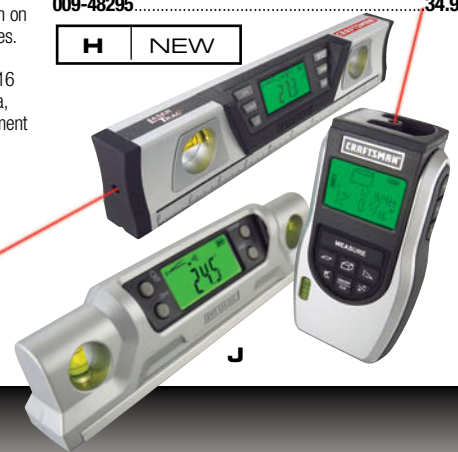

J



Catalog/Online EXCLUSIVE
K. General® 4-piece Machinist's Combination Square. 12-inch satin chrome-hardened, tempered blade. Level vials on square and protractor heads. Patented locating screws on all heads make assembly quick and easy. Center and square heads fully hardened. Graduations finely etched for pinpoint accuracy (64ths-front; 8ths, 1/16ths-back). Reversible protractor head is graduated 180 degrees left and right. Includes scribe. Meets Federal Specifications GGG-S-656C. Type IV, Class A. Warranted*. Wt. 2.56 lbs.
009-38700 159.99



Catalog/Online EXCLUSIVE
L. M-D Building Products Digital Protractor. State-of-the-art sensor and microprocessor provide immediate digital indication of level, plumb and all angles in between. Full 360-degree range. 0.1 degree resolution, ± 0.1 degree repeatability. Accuracy ± 0.1 level and plumb ± 10 degrees, also ± 0.2 maximum error. Hold button freezes current display. Rugged aluminum frame with integral base plate. Includes case and 9-volt battery. Full 1-year warranty.* Wt. 0.63 lb.
009-40195 199.99



V NEW
digital readout includes case

Catalog/Online EXCLUSIVE
V. NEW Craftsman 48-inch Digital Level with Soft Storage Case. The easy-to-read 2-inch LCD screen displays measurements in degrees, inch/foot or percent of grade and is accurate to ± 0.1 degrees. Memory recall remembers up to nine measurements and a zero button calibrates to any surface. Includes soft case and 47-in. integrated ruler. Wt. 2.58 lbs.
009-79583 79.99

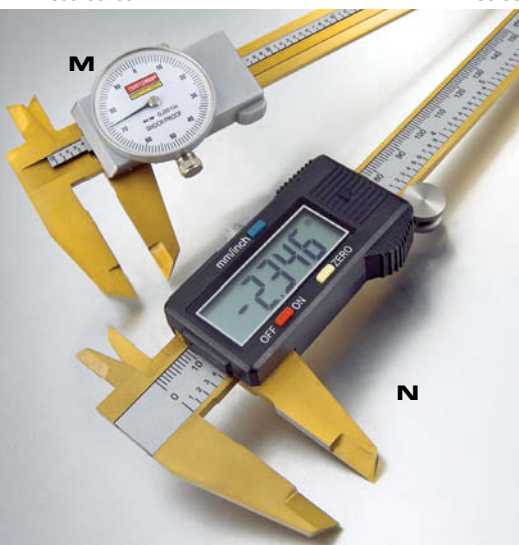

Catalog/Online EXCLUSIVE
M. Craftsman Professional Gold Titanium Nitrate-Coated 0-6-inch Dial Caliper. Hardened stainless steel with gold titanium nitrate coating for wear- and corrosion-resistance. 0-6-inch, one-revolution dial caliper with .001-inch graduations. Four-way measurements: outside, inside, step and depth. Covered rack, precision lapped measuring surfaces, shock-proof, adjustable bezel with lock. Wt. 1.1 lbs.
009-40778 79.99

Catalog/Online EXCLUSIVE
N. Craftsman Professional Gold Titanium Nitrate-Coated 0-6-inch Digital Caliper. Made of hardened stainless steel with a gold titanium nitrate coating for durability. Measures four ways: inside, outside, step and depth. Floating zero setting, reads inch or metric (.0005 in./0.01 mm). Thumb wheel and lock, on/off button. Wt. 0.75 lb.
009-40772 114.99
Also Available
Craftsman 0-12 inch Dial Caliper. Wt. 1.75 lbs. **009-40186 79.99**
Craftsman 0-8 inch Dial Caliper. Wt. 1.44 lbs. **009-40188 59.99**
Craftsman 0-6 inch Dial Caliper. Wt. 1 lb. **009-40185 44.99**

Catalog/Online EXCLUSIVE
W. NEW Sola® Big Red Level. Takes daily rugged use, as well as high and low temperature changes, and still maintains its accuracy. Features 3 times magnification of the level vial for easy reading and a bubble that is tight to the lines for accuracy. Features co-molded end caps for durability and a milled working surface. Made in Austria.
009-60512 24-Inch. Wt. 1.41 lbs. 69.99
009-60514 48-Inch. Wt. 2.61 lbs. (shown) 99.99
009-60515 72-Inch. Wt. 3.88 lbs. 169.99

W NEW

Catalog/Online EXCLUSIVE
P. Starrett® Woodworker's Fractional Dial Caliper. Measure width or depth of slots, thickness, drill diameter and more. Fractions on yellow outer scale with 1/64th-in. graduations, and decimal on white inner scale with 1/100th-in. graduations. Has 0 to 6-in. range with 1-in. per rev. Thumb-operated fine adjust roll, lock screws for sliding jaw and dial bezel, covered rack depth rod, knife-edge contacts and adjustable bezel. Wt. 0.7 lb.
009-40176 129.99

Catalog/Online EXCLUSIVE
Q. Starrett® 797 Electronic Slide Caliper. 0-6-inch slide caliper with easy-read display, IP65 protection against coolant, water, dirt and dust. Inch/mm conversion, .0005-inch resolution and RS232 output. Jaw depth approx. 1 1/2-inch outside and 5/8-inch inside. Includes long-life 3-volt battery. With plastic case. Warranted*. Wt. 0.43 lb.
009-40161 179.99

Catalog/Online EXCLUSIVE
R. Starrett® 6-inch Deluxe Dial Caliper. Four-way reading: outside, inside, shoulder, depth. One-hand, thumb-operated fine adjust roll. Has .001 graduations with .100-in. per rev. Includes case. Warranted*. Wt. 0.7 lb.
009-40164 - Red Face Dial 159.99
009-40165 - White Face Dial 159.99



S. Starrett® Electronic Digital Micrometer. Outside micrometer has a 0 to 1-inch range with instant inch/millimeter conversion. Counter reads to .00005 inch with ± 0.0001 inch accuracy. Includes one 3-volt battery. Warranted*. Wt. 0.43 lb.
009-40167 219.99

Catalog/Online EXCLUSIVE
X. NEW Sola® Wet/Dry Pencils. Package of 13 unique carpenter's pencils that can write on wet lumber or tile. Made of lime-wood and graphite plus other special ingredients, pencil is 30 percent more resistant to breaking. 25 percent longer than the standard carpenter's pencil. Includes 13 pencils. Made in Europe. Wt. 0.3 lb.
009-87862 19.99

Y. Scale Master® II Advanced Linear Digital Plan Measure. For fast, accurate takeoffs from scaled or unscaled prints, plans and drawings. 91 built-in scales (engineering map, blueprint), plus 8 custom. Wt. 0.48 lb.
009-39743 99.99

X NEW

T. Craftsman Professional Advanced Construction Calculator. Reduce errors and save time with this versatile calculator. Includes built-in right-angle solutions for square-up and slopes; complete stair solutions for risers, treads and stringers; rafter and framing solutions and more. Works in feet, inches, fractions, yards and metric (including square and cubic formats of each). Includes hard rubber case. Wt. 0.7 lb.
009-39785 49.99

Catalog/Online EXCLUSIVE
U. NEW Sola® 24-inch Inclinometer (Angle Finder) with Carry Bag. Finds any angle in degree or percent. Rotate the disc until the vial reads level and you have found your angle. Great for setting ramps, pitch or slope. Made in Austria. Wt. 1.87 lbs.
009-60525 99.99

includes hard rubber case



U NEW

*Warranted, see page 94a.
 ● See page 94a for laser use and precautions.



A. Craftsman 6-piece Wood Chisel Set with Case. Ergonomic handle for comfort and control. Drop-forged high carbon steel blades with precision-machined edges. Metal cap handles impact. Includes 1/4 thru 1 1/2-inch blades. 600-denier nylon bag with blade protection pocket. Chisels made in USA. Separate prices total \$62.94. Wt. 3.5 lbs.
009-36866.....29.99



B. Spring Tools 6-piece Combination Metal/ Woodworking Punch/Chisel Set. Includes safe, high-tension spring-driven steel center punch, self centering center punch, center punch/prick punch combination, cold chisel, combination #1/#2 nail setter and wood chisel in reusable plastic case. Powerful lifetime spring delivers 3,500 psi of striking force to 8 essential tool tips. Use for metal layout, setting nails, chiseling wood, mild steel and rivets. Perfect for tight places. Machined from heat-treated high-speed tool steel and high carbon steel. Includes case. Made in USA. Patented. Warranted*.
Wt. 1 lb.
009-36896.....49.99



C. Spring Tools 19-piece Impact Driver Set. Patented design combines impact tool and screwdriver for removing or re-coining damaged, corroded or rusty fasteners. Pull back the high-tension spring with the ball end and release with 5,000 psi striking force to reshape the turning slot or shock a frozen fastener, then use any of the 16 hardened, heat-treated 2 in. bits included or any other 2-in. power bit to remove fastener. Includes Phillips 0, 1, 2, 3; slotted 5, 7-8, 8-9; square recess S1, S2, S3; Torx® T20, T25, T30; nut driver 1/4, 5/16; 1/4 in. hex-to-square socket adapter and center punch, and case. Wt. 1.6 lbs.
009-47308.....39.99



D. Spring Tools Hammerless ID Stamper. Ideal for marking parts, preventing theft and inventory control, this comprehensive ID set marks soft to medium hard metals, wood and some plastics. Features high-tension spring that delivers 3,500 psi of striking force to quickly and easily stamp items without use of hammer. 37 characters include ampersand, period, letters A thru Z and numbers 0 thru 9. Wt. 1 lb.
009-36895.....39.99

Personalized Soft Storage – Catalog/Online EXCLUSIVES

F-H. Craftsman Professional Soft Storage. A great gift idea! Craftsman now offers heavy-duty tool bags with the option to be personalized. All these sturdy bags are crafted in good ToughWear™, a lightweight material with proven durability.



F. Craftsman Professional 18-inch Double-Wide Tool Bag. Large cargo pockets with flaps to secure tools. Two separate full-length storage compartments and three removable inner zipper pouches. Wt. 4 lbs.
009-48351.....34.99
P Personalized 009-48411.....44.99

G. Craftsman Professional 14-inch Compression Tool Bag. Compression-molded foam bottom protects contents. Dual zipper with steel frame opening for durability. Wt. 3.5 lbs.
009-48346.....26.99
P Personalized 009-48413.....36.99

H. Craftsman Professional 14-inch Mini Double-Wide Tool Bag. Two separate full-length storage compartments and large cargo pockets with flaps. Adjustable, padded shoulder strap. Wt. 3.4 lbs.
009-48442.....26.99
P Personalized 009-48412.....36.99

TWEAKER®

pull, adjust, strip & wedge wood – also pulls nails



E. Tweaker® Lumber Leverage Tool and Nail Puller. A framer's best friend, this multipurpose tool features a comfortable orange foam grip. Measures 14 1/2 inches. Fits most tool boxes. Wt. 2 lbs.
009-38076.....24.99



J. NEW The Leather ToolRider Rig. This Gelfoam suspension rig features oil tan leather pouches, padded back and suspenders with stretch suspension. Wt. 4.75 lbs.
009-83266.....199.99



K. NEW ToolRider™ Carpenter's Pouch. Made from ballistic nylon material, the toughest fabric on the planet, this one-piece design offers maximum durability. Three layers of pockets offer super capacity and easy access to tools. Features external cell phone holder, reinforced hammer loop and an open end tool slot. Wt. 1.7 lbs.
009-83267.....34.99

Scott Plowman



P Personalize it!



L. Padded Electrician Suspension Rig. Ballistic nylon with lightweight gelfoam padded belt and detachable suspenders. Both stay dry with a Drilex™ moisture-wicking lining. Features include cell phone pocket, velcro-captured adjustable pouches, hammer loop and tape measure clip. Wt. 19 lbs.
009-74993.....99.99

Check online for SALE PRICING!



M. NEW FloorWalkers™ Gel Knee Pads. Constructed of 100% real gel padding which lasts much longer than foam. Replaceable Gel PODS extend the life of the kneepad. Lightweight and low-profile for easy movement. Neoprene stretch straps with loop in closure for better fit, more comfort and easy adjustability. Wt. 2 lbs.
009-83268.....39.99

CRAFTSMAN®

WOODWORKING



N. Craftsman 5-piece Steel Handle Ball Pein Hammer Set. Crafted with full polished, drop-forged steel head and handle, these hammers feature precision machined striking face that assures uniformity and accurately crowned face and bevel. Patented "Power Plug" shock-absorbing core reduces vibration and shock transfer to user's arm, wrist and elbow. Cushioned comfort grip. Includes 8, 12, 16, 24 and 32 oz. hammers. Made in USA. Wt. 12 lbs.

009-38528 99.99

P. NEW-SAVE OVER 20% Craftsman 3-Piece Hammer, Bar and Puller Set. Designed for maximum performance with minimum wear and tear on wood. The 15-inch reversed hook pry bar increases leverage of the "sweep" claw and travel capacity of the shepherd's hook. The 11 3/4-inch nail puller offers excellent leverage and increased strength. The 19-ounce steel-handled hammer features chevron grip, magnetic nail holder and a side nail puller. Separate prices total \$64.97. Wt. 5 lbs.

009-87773 49.99

Q. Craftsman 19-ounce Heavy Construction Steel Handle Hammer. Patented head and reinforced claws reduce shock and aid prying. Side nail puller provides extra leverage. Nail starter holds standard and duplex nails. Ideal for framing, form work and tear-outs. Wt. 2 lbs.

009-38061 34.99

Catalog/Online EXCLUSIVE

R. Craftsman 5-piece Hickory Handle Ball Pein Hammer Set. Includes dual plastic tip hammer with 12-ounce steel core head and 12 1/2-inch hickory handle. Features one hard and one soft tip to prevent damage to striking surface. Also includes four ball pein hammers with 12, 16, 24 and 32-ounce drop-forged, heat-treated heads. Feature hickory handles. Separate prices total \$81.95. Wt. 8.5 lbs.

009-38074 59.99

S. Craftsman 48-ounce Double-Faced Engineer's Hammer. Large crowned striking face. 15-inch heavy-duty solid fiberglass handle, contoured molded grip. Overstrike guard. Wt. 3.6 lbs.

009-38261 21.99

T. Craftsman 48-ounce Driller Hammer. Drop-forged steel head and handle. Oversized striking face ideal for use on star drills, cold chisels, brick chisels and punches. Patented "Power Plug" shock absorbing core reduces vibration and shock transfer. Cushioned comfort grip. Overall length 10 1/2 inches. Made in USA. Wt. 3.75 lbs.

009-38527 24.99

Catalog/Online EXCLUSIVE

U. Craftsman 3-piece Dead Blow Hammer Set. Includes 1-pound, 2-pound and 3-pound hammers. Designed for severe striking applications, the dead blow hammer helps reduce vibration. Cast urethane striking surface. Non-recoil hammer with nylon composite inner chamber is loaded with buckshot to help reduce the impact of hammer blows. Solid fiberglass handle with an ergonomic grip to help eliminate hammer rebound. Separate prices total \$97.97. Guaranteed Forever!® Wt. 6 lbs.

009-38358 89.99

Also Available

Craftsman 2-piece Hammer Set. Includes 2-pound and 3-pound hammers. Separate prices total \$69.98. Guaranteed Forever!® Wt. 5 lbs.

009-38085 64.99

V. Vaughan S2 Split Head Hammer. Patented 3-piece design with anti-vibration pads to virtually eliminate shock. Precision balanced and featuring an American hickory handle and magnetic nail starter that holds both standard and duplex nails. Made in USA. Wt. 4.2 lbs.

009-38065 37.99



W. Nupla 2-piece Brass Striking Hammer Set. High-quality naval brass heads for soft metal striking applications. Fiberglass handles includes 1.5-pound and 2.5-pound hammers. Wt. 5 lbs.

009-38088 64.99



X. Extech Moisture Meter. Perfect for checking moisture in wood and other materials. Ideal for the woodworker and building contractor. Two separate ranges, LCD display with bar graph. Use on wood, sheet rock, concrete and more. Pocket-sized with belt clip. Impact-proof housing and auto power off. Warranted*.

Wt. 0.3 lb. 034-14080 79.99

Y. NEW

Catalog/Online EXCLUSIVE
Y. NEW Extech Pinless Moisture Meter with Built-in Infrared Thermometer. Get a quick read on moisture content in wood and other building materials with no surface damage. Measures moisture content 0 to 99% in 10 species of wood. Features dual line LCD display, data hold, Min./Max. memory. Operating temperature range -4°F to 140°F; humidity range 10 to 95% RH; and dew point range -22°F to 199°F. Operating temperature range of infrared -58°F to 932°F. Includes batteries and instructions. Wt. 0.08 lb.

034-90270 379.99

Catalog/Online EXCLUSIVE
Z. NEW Extech Pinless Moisture Meter. Non-invasive moisture content of building materials and wood. Select from 10 wood types and measurement ranges. LCD displays % moisture of material being tested. Includes 9v battery and case. Measurement depth to 0.75 inches below the surface. Automatic internal test and calibration. Electro-magnetic testing technology. Low battery indicator. Wt. 0.05 lb.

034-99991 129.99



*Warranted, see page 94a.
P See page 43 for more information.

Catalog/Online EXCLUSIVE

A. NEW 20-piece Deluxe Woodworkers Kit. A comprehensive selection of essential tools to execute all your woodworking projects. Set includes tools for marking, layout, sharpening, and finishing. Also comes with seven chisel sizes, three saws and a mallet. Crafted with quality materials including rosewood, beech wood and brass and Sheffield steel blades. Wt. 5.5 lbs.
009-82854 399.99

Catalog/Online EXCLUSIVE

B. NEW Footprint 15-piece Woodworker's Kit. Complete with all the basic tools for your woodworking projects, this set includes tools for marking, layout, seven chisel sizes, three saws and a mallet. Crafted with quality materials including rosewood, beech wood and brass. Wt. 4.6 lbs.
009-82853 299.99

Catalog/Online EXCLUSIVE

C. NEW Footprint 3-piece Plane Set. Features precision-ground cast iron bodies, high-carbon steel blades and stained hardwood handles. Set includes a 14 in. extra-long jack plane for leveling and squaring, a 7 in. x 1 5/8 in. block plane for smaller jobs and a 9 3/4 in. x 2 in. smooth plane for final finishing. Separate prices total \$119.97. Wt. 13 lbs.
009-37763 109.99

Also Available

Footprint Smooth Plane. 9 3/4 in. x 2 in. Wt. 5 lbs.
009-37740 39.99
Footprint Block Plane. 7 in. x 1 5/8 in. Wt. 2 lbs.
009-37741 29.99
Footprint Jack Plane. 14 in. x 2 in. Wt. 6 lbs.
009-37764 49.99

Catalog/Online EXCLUSIVE

D. NEW Footprint 10-piece Red Handle Chisel Set. Durable, shatterproof cellulose acetate handles hold fully-machined blades forged from high-carbon Sheffield steel and tempered to Rockwell 60-61. Set includes sizes 1/8, 1/4, 3/8, 1/2, 5/8, 3/4, 7/8, 1, 1 1/4 and 1 1/2 inch. Wt. 4.8 lbs.
009-82851 199.99

Catalog/Online EXCLUSIVE

E. NEW Footprint 7-piece Wood Handle Chisel Set. Superbly crafted with comfortable beech wood handles, these precision chisels feature blades forged from high-carbon Sheffield steel and tempered to Rockwell 60-61. Blades are fully machined on all faces. Set includes sizes 1/4, 3/8, 1/2, 5/8, 3/4, 7/8 and 1 inch. Wt. 2.9 lbs.
009-82852 119.99

Catalog/Online EXCLUSIVE

F. Footprint Tools 9-piece Chisel Set. Drop forged from high-carbon Sheffield steel and designed for the toughest jobs. Hardened 58-61 Rockwell C to 1 inch from the bolster. Flattop polypropylene handles withstand heavy hammer blows and are guaranteed not to break. The oval shape fits comfortably in your palm, while the textured finish provides a sure grip. Set includes 1/4, 3/8, 1/2, 5/8, 3/4, 7/8, 1, 1 1/4, 1 1/2 in. blades. Blades are 4 inches long. Warranted*. Wt. 3.9 lbs.
009-36817 99.99



15-PIECE SET

B NEW

A NEW

20-PIECE SET

D NEW

E NEW

C NEW

MORE WOODWORKING TOOLS AT SEARS.COM/SHOPTOOLS



Catalog/Online EXCLUSIVE

G. General Tools 22-piece Woodworking Knife and Blade Kit. Ideal for precision cutting of a variety of materials, tools feature heavy-duty locking screw chucks and Versa-Grip™ handles. Comes with 2 multi-blade handles, 20 blades and case. Wt. 1.5 lbs.
009-88588 24.99

Catalog/Online EXCLUSIVE

H. Schroeder Heavy-Duty 1/2-inch Rotary Breast Hand Drill. Breastplate for additional drilling force. Fully enclosed gears, 2-speed, detachable rotary handle and a 3-jaw chuck with a 1/2 in. bit capacity. Wt. 3.2 lbs.
009-34093 64.99

Catalog/Online EXCLUSIVE

J. Schroeder Heavy-Duty 5/16-inch Rotary Hand Drill. Use where there's a lack of electricity. Features milled gears and 3-jaw chuck with a 5/16 in. bit capacity. Hardened, ground jaws for precision, and all-steel design with gunmetal finish. Wt. 1.4 lbs.
009-34094 29.99

Catalog/Online EXCLUSIVE

K. WorkSharp Precision Tool Sharpener and Shop Grinder. Sharpens and grinds bladed shop tool such as chisels, axes, scrapers, lawn mower blades and more. Uses adhesive-backed abrasives. Edge-Vision shows the edge as you grind. 1,750 rpm. Warranted.* Wt. 8 lbs.
009-21187 119.99

Catalog/Online EXCLUSIVE

L. WorkSharp WS3000 Wood Tool Sharpener. Air-cooled, dry unit sharpens chisels and planes blades up to 2 inches wide to a 20, 25, 30 or 35-degree angle. Features 580 rpm wheel and Edge-Vision for view of work. Uses tempered glass wheel and adhesive backed abrasives in multiple grit sizes. Warranted.* Wt. 16 lbs.
009-21198 199.99

Also Available

Replacement Glass Wheel. Wt. 1.13 lbs.
009-21670 19.99
Leather Hone Kit. Wt. 1.31 lbs.
009-21669 29.99
Coarse Abrasive Kit. Wt. 0.5 lb.
009-21667 15.99
Fine Abrasive Kit. Wt. 0.5 lb.
009-21666 15.99
Slotted Abrasive Kit. Wt. 0.5 lb.
009-21664 19.99

Craftsman Bar Clamps

Catalog No.	Size	Wt., lbs.	Price
009-31480	4 3/5-in.	0.29	\$9.99
009-31483	6-in.	2.07	16.99
009-31484	12-in.	2.43	19.99
009-31485	18-in.	2.75	21.99
009-31486	24-in.	3.10	23.99
009-31489	33-in.	4.09	29.99
009-31487	36-in.	3.88	26.99
009-31481	6-in. mini	1.00	14.99
009-31482	12-in. mini	1.20	16.99

Craftsman Steel Bar Clamps

Catalog No.	Size	Wt., lbs.	Price
009-66731	6-in.	1.44	\$11.99
009-66732	12-in.	1.87	14.99
009-66733	18-in.	2.13	15.99
009-66734	24-in.	2.50	16.99
009-66735	36-in.	3.00	18.99

Features laser guidance system helps to cut with confidence!



MORE TO EXPLORE
at sears.com!

Catalog/Online EXCLUSIVE

Q. Titebond® Original Wood Glue™ 2-Gallon Value Pack. Aliphatic resin glue provides a strong initial tack, fast set and excellent sandability. For wood, hardboard, particleboard, leather, cloth and most other porous materials. Non-toxic, cleans up with water, conforms to ASTM D4236, VOC Compliant. Wt. 20 lbs. **009-66597.....36.99**

Catalog/Online EXCLUSIVE

R. Titebond® III Ultimate Wood Glue™ 2-Gallon Value Pack. Bonds porous wood and wood type materials. Strong initial tack, superior strength, sandable, non-toxic. Cleans up with water, meets ANSI/HPVA Type 1 water resistance specification, FDA approved for indirect food contact. Wt. 20 lbs. **009-66598.....62.99**

Catalog/Online EXCLUSIVE

S. Bora Clamp Edge. Ideal for all types of woodworking and carpentry that require precision. Works as a guide for routers, circular and sander saws. Durable aluminum body maintains straight, accurate cuts and clamping. Soft-grip clamping pads protect worksurface. Clamp straight or angles firmly up to 22.5 degrees. Oversize clamping handle for increase leverage and comfort. 58.5 in. guide surface. Wt. 3.25 lbs. **009-66423.....39.99**

Also Available
36-in. Bora Clamp Edge. Wt. 2.31 lbs. **009-66425.....34.99**
24-in. Bora Clamp Edge. Wt. 2 lbs. **009-66424.....29.99**



M. Craftsman Bar Clamps. Designed for convenient one-handed operation, these versatile clamps feature a quick-release, reversible jaw to easily convert to spreader. Features include cushioned handles, non-marring clamp pads and incremental release lever. V-groove pads design clamps round objects as well. **009-31484.....19.99**

N. Craftsman Steel Bar Clamps. Sturdy design features 2 1/2 in. throat depth and clamp pads. **009-66732.....14.99**

Catalog/Online EXCLUSIVE

P. Spear & Jackson Laser-Guided Woodsaw. Whether you're making straight cuts, cutting profiled surfaces, cutting difficult-to-mark surfaces, trimming a thin slice or making complex compound mitre cuts, the guidance system provides improved accuracy and confidence. The 10PPI Sheffield manufactured blade ensures unparalleled accuracy. Wt. 1.12 lbs. **009-87902.....34.99**



authentic bamboo-wrapped handles!



These awesome hand saws from Japan can help solve your precision cutting challenges.

TONY'S PICK



Catalog/Online EXCLUSIVE

T. NEW Fisco® Big T Measuring Tapes. Ergonomic design for comfort with rubber over-molds and internal shock absorbers protect against damage from 2-story drops! Patented snap-on belt holster. Superior positive action break locks the blade solidly. Auto return, carbon spring steel tape with clear view end hook and bump stop to cushion blade return.

009-87714	12-ft. x 3/4-in.	Wt. 0.55 lb.19.99
009-87720	5m x 3/4-in.	Wt. 0.66 lb.19.99
009-87718	16-ft./5m x 3/4-in.	Wt. 0.66 lb.19.99
009-87715	16-ft. x 3/4-in.	Wt. 0.66 lb.21.99
009-87721	8m x 1-in.	Wt. 1.1 lbs.26.99
009-87719	26-ft./8m x 1-in.	Wt. 1.1 lbs.26.99
009-87716	25-ft. x 1-in. (shown)	Wt. 1.1 lbs.24.99
009-87717	30-ft. x 1-in.	Wt. 1.21 lbs.29.99

Fisco® Big T tapes available in 8 sizes.



Catalog/Online EXCLUSIVE

U-X. Tokutaro Traditional Japanese-Style Pull Saws. Cutting wood on the pull stroke allows for a thinner blade that delivers a faster, more precise cut. The locking blades are crafted in durable, rust-resistant spring steel with specially ground, tri-edge teeth, hardened for lasting sharpness. Includes blade guards. Order from chart below.



RYOBA saw bends for challenging cuts

Tokutaro Traditional Japanese-Style Pull Saws

Item	Catalog No.	Blade	Wt., lbs.	Price
U.	009-82858	"RYOBA" Double-Edged Saw	1.00	\$27.99
V.	009-82859	"DOZUKI" Dovetail Saw	0.75	29.99
W.	009-82862	Flush Cut Saw	0.50	12.99
X.	009-82863	Trim Saw	0.50	9.99
	009-82864	4-pc. - Japanese Saw Combo	3.00	69.99

*Warranted, see page 94a.

WOODWORKING

works with
T-50 staples!!

A NEW



ALL WALL LENK TOOLS ARE
Catalog/Online EXCLUSIVE

C. NEW Lenk LSP-180 SolderPro™ Soldering Tool/Blow Torch Kit. Cordless soldering tool with pistol grip gun. Designed for continuous, heavy-duty use. Soldering tip heats from 410° F. to 1,000° F. Torch reaches 2,400° F. Includes butane-powered soldering gun and heat tool, chisel tip and two butane fuel cells. Wt. 1.25 lbs.
009-5405759.99

D. NEW Lenk LSP-110 2-In-1 SolderPro™ Soldering Iron/Blow Torch Kit. Auto ignition is easy to start and operate under any condition. Soldering iron functions from 410° F. to 750° F. Torch is adjustable to 2,400° F. Easy to refill with see-through fuel window. Warranted.* Wt. 0.35 lb.
009-8867239.99

E. NEW Lenk LSP-60 4-In-1 SolderPro™ Soldering Iron Kit. Pocket-sized butane iron offers optimum convenience. Includes heat tool, cap with manual striker, heat shield, four tips (blow torch, heat gun, pointed solder, hot knife) and case. Soldering iron functions from 410° F. to 750° F. Torch is adjustable to 2,400° F. Wt. 1 lb.
009-8867049.99

C NEW



D NEW



E NEW



Catalog/Online EXCLUSIVE

A. NEW Arrow Professional Cordless Staple Gun. This rugged, lightweight unit delivers professional results with ease. Powered by a 10.8-volt lithium-ion battery, stapler features an LED guide light, adjustable depth dial, safety trigger switch, battery meter, non-skid battery grip, battery, charger and storage case. Holds up to 2 strips of T-50 staples, firing over 1,500 staples per charge. Wt. 9.06 lbs.
009-88437139.99

B. Craftsman Professional Heavy-Duty Forward Action™ Stapler. Fires staples and brad nails. Drives staples flush easily with one hand. Anti-slip comfort grip. Reduces kickback compared to a rear-action stapler. Features staples/nails remaining window. With free wire guide. Durable steel body. Made in USA. Wt. 1.98 lbs.
009-6851529.99



Woodworker's

F

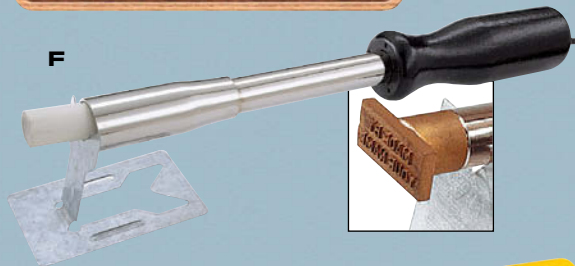

F. NEW Lenk CM-125W Branding Iron. Customize your work with your personal brand. Includes 125-watt branding iron, stand and case. Fill out and send enclosed order form, and your customized head is shipped from manufacturer within two weeks. Wt. 1.1 lbs.
009-8867669.99

G. NEW Lenk L25TT Professional Transfer Tool. Transfer images and patterns from printouts to wood, leather and fabric. 850° F maximum point temperature. Includes L16RH transfer head, 25-watt transfer tool and tool stand. Wt. 0.3 lb.
009-8867714.99



H. NEW Lenk L101KB 10-in-1 Creative Tool Kit. This multipurpose tool kit can be used for burning, branding, soldering, cutting and fusing. Comes with a 30-watt professional iron, 7 wood burning tips, 2 cutting tips, 1 pointed soldering tip, tool stand and case. Warranted.* Wt. 0.9 lb.
009-8867329.99



J. NEW Lenk L30BBK Burning and Branding Kit. Kit includes 30-watt professional iron with 4 woodburning tips and 4 branding tips, tool stand and storage case. Wt. 0.95 lb.
009-8867429.99

ALL NEW



K



K. NEW Lenk L30WBK-W Woodburning Kit. Develops tip temperature up to 1,050° F. to burn wood faster and darker for maximum results. Short shaft brings work closer. Heat shield keeps handle cool. Includes all-purpose tip, pointed tip, shading tip, dot tip, tool stand and instruction sheet. Wt. 0.3 lb.
009-8867917.99

replaceable wood-burning tips

heat shield

handle stays cool



ALL NEW

M

L

N

SEBER KNIFE

L & M have partial serrated blades and black wooden case



ALL NEW

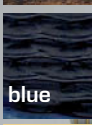

more colors available online



WOODWORKING

Catalog/Online EXCLUSIVE

L. NEW Seber Black G10 Composite Handle Ratcheting Knife. Knife is crafted with stainless steel bolsters and frame. Featuring a military style drop point, partially serrated blade and outfitted with a G-10 composite handle. Claw-Loc™ ratcheting blade lock system and Rotation-Loc™ system locks blade at any angle for multiple uses. Thumb stud for one-handed operation. Blade locks in open or closed position for safety. Includes built-in belt clip and black wooden case. Wt. 7 oz.
009-8297259.99

M. NEW Seber Black Ratcheting Military Knife. Featuring a military style drop point and partially serrated blade, this knife is crafted with a stainless steel frame and Bolsters and G-10 composite handle. Claw-Loc™ ratcheting blade lock system and Rotation-Loc™ system locks blade at any angle for multiple uses. Thumb stud for one-handed operation. Blade locks in open or closed position for safety. Includes built-in belt clip and black wooden case. Wt. 7 oz.
009-8296359.99

N. NEW Seber Stainless Steel Ratcheting Utility Knife. Crafted in stainless steel, this rugged knife features the Claw-Loc™ ratcheting blade lock system and Rotation-Loc™ system locks blade at any angle for multiple uses. G-10 composite handle. Blade release button on handle away from blade for added safety. Blade locks in open or closed position for safety. Includes built-in belt clip. Wt. 8 oz.
009-8296249.99

Catalog/Online EXCLUSIVE

P-R. NEW W.R. Case & Sons Cutlery®. See more Case Cutlery® styles and colors online!

P. NEW Pocket Worm® Bermuda Green Bone Trapper Knife. Tru Sharp™ surgical steel clip and spey blades. Wt. 0.26 lb.
009-8321554.99

Q. NEW Pocket Worm® Bermuda Green Bone Stockman Knife. Tru Sharp™ surgical steel clip, spey and sheepfoot blades. Wt. 0.16 lb.
009-8321652.99

R. NEW Pocket Worm® Bermuda Green Bone Peanut Knife. Tru Sharp™ surgical steel clip, spey and sheepfoot blades. Wt. 0.08 lb.
009-8321744.99



T NEW

S NEW

6-12 gauge wire

10-18 gauge wire

S & T. NEW Rapid Shark® Combo Utility Knife and Wire Stripper, Crimper and Cutter. Unique, timesaving tool that combines a high-quality utility knife with a versatile wire stripper/cutter/crimper. Features one-button blade change and precision stripping holes. Comes with five serrated Rapid Edge® blades.

S. Standard Bite Rapid Shark®. Red. Wt. 0.7 lb.
009-8970019.99

T. Big Bite Rapid Shark®. Yellow. Wt. 0.8 lb.
009-8978824.99

U. NEW Rapid Edge® 100-Blade Pack. Patented serrated edge reduces friction, stays sharper and lasts longer than standard straight edge blades. For use with Shark Knives. Wt. 1 lb. See more Rapid Edge® replacement blades online.
009-8987229.99



U NEW

Catalog/Online EXCLUSIVE

V. Craftsman 7-inch Blade Sharpener. Uses combination of wet and hollow grinding to create very fine edges. Aluminum oxide 1,000-grit wheel rotates through water trough to keep blade cool. 1/5-hp motor with 450 rpm. 7 in. x 3/4 in. wheel with 2 3/4 in. bore. Adjustable tool seat. Tools not included. Imported. Warranted*. Wt. 14.5 lbs.
009-2117189.99



X NEW

Y NEW

VICTORINOX

RescueTool

X. NEW Victorinox Swiss Army Champion Plus Knife. A full size, 30-function knife that features large and small knife blades, scissors, can/bottle opener, wood/metal saws, magnifying glass, flat head/Phillips screwdrivers and more. Swiss-made. Lifetime replacement warranty.* Wt. 7 oz.
009-5041949.99

Catalog/Online EXCLUSIVE

Y. NEW Victorinox Swiss Army Rescue Tool. Indispensable to have at your side in any emergency, this tool features removable window breaker for shatterproof glass and disc saw for cutting seat belts. The fluorescent handle makes it easy to find. Tool features large locking blade, Phillips screwdriver, window breaker, crate opener with bottle opener, wire stripper, reamer, punch, key ring, tweezers. Includes nylon cord and pouch. Wt. 0.9 lb.
009-8295989.99

Z. NEW Diamond Pen File. 5 5/8-in. long, portable file screws in handle, round, 600 grit/fine. Wt. 0.2 lb.
009-8286559.99

AA. NEW 10-inch Diamond Sharpening Steel. 600 grit/fine. Wt. 2 lbs.
009-8300564.99

Catalog/Online EXCLUSIVE

BB. NEW Trend® Diamond Sharpening Set. Double sided stones are ideal for quickly flattening chisel and plane blades, sharpening knives, router bits and carving tools. Finished to a tolerance of ± 0.0005 in. Kit includes 7 x 2 1/2-inch bench stone, pouch, heavy-duty bench holder, credit card stone, lapping fluid and "how to" DVD. Wt. 4 lbs.
009-82855229.99



BB NEW

AA NEW



W

Z NEW

SEARS.COM/SHOPTOOLS
Sign up to be notified when items go on sale.

W. Craftsman 4-inch Reversible Blade Sharpener. Keep tools sharp with this versatile machine. Two adjustable tool rests lock at any angle for angle sharpening and to improve accessibility. Features smooth operating 0.7-amp motor. Large plastic housing for support during sharpening. Warranted*. Wt. 11 lbs.
009-2117449.99

ADVANTAGE CRAFTSMAN OUR BEST VALUES



33 GALLON

A

- delivers 150 psi max
- quiet operation 78 dBs per ISO 3744
- oil-free, maintenance-free pump
- extension cord-friendly! can use with 12-gauge extension cords up to 50 feet



both A and B include this 10-pc. accessory kit

Catalog/Online EXCLUSIVE SAVE \$50 A & B. Craftsman 33-Gallon, 1.6-rhp, Vertical or Horizontal Tank, Oil-Free Pump Air Compressor with 10-piece Air Tool Accessory Kit. Largest air tank for more air tool runtime than any competitive retail compressor. New pump and motor delivers 4.9 SCFM at 90 psi per ISO1217. Lower start-up for fewer tripped breakers. Use with any 120-volt extension cord up to 50 feet. Quieter running at 78 dBs. Regular price \$479.98.

- A. 009-17662N ♦ Vertical Wt. 146.3 lbs.....429.98
- B. 009-17663N ♦ Horizontal Wt. 135.3 lbs.....429.98



33 GALLON

B

CUSTOMER review

“Great compressor, and very friendly service from our Sears folks.”

CarpenterKid
Birmingham, AL

- detaches from dolly for versatility
- portable for convenience
- includes 17-piece kit

4 GALLON

C



both C & D include this 17-pc. accessory kit

- detaches from dolly for versatility
- portable for convenience
- includes 17-piece kit
- telescoping handle

5 GALLON

D



7 GALLON

E

- easy to move from job to job
- direct-drive oil-lube pump

both E & F include this 17-pc. accessory kit



- easy to move from job to job
- direct-drive oil-lube pump

12 GALLON

F



*Warranted, see page 94a.

♦See "N" suffix note on page 94a.

CHECK OUT THE AIR COMPRESSOR RECOMMENDATION CHART ONLINE AT SEARS.COM/SHOOTOOLS



AIR COMPRESSORS

air ratchet not included

26 GALLON

CRAFTSMAN

Craftsman oil-free compressors feature nickel-plated steel cylinder sleeves and permanent lube compression rings for years of maintenance-free operation.

Craftsman Air Compressors and Combo Kits

Description	Catalog Number	Tank Gal.	SCFM @ 40 PSI	SCFM @ 90 PSI	Volts	Max PSI	Air NPT Outlet	Dimensions	Weight Lbs.	Includes	Price
A. 33 Gal.-Vertical 1.6-rhp Oil-Free Compressor Combo Kit [†]	009-17662N◆	33	6.3	4.9	120	150	1/4	24.00 x 22.50 x 51.25	146.3	10-pc. Air Tool Accessory Kit	\$429.98
B. 33 Gal.-Horizontal 1.6-rhp Oil-Free Compressor Combo Kit [†]	009-17663N◆	33	6.3	4.9	120	150	1/4	40.88 x 17.66 x 35.00	135.3	10-pc. Air Tool Accessory Kit	429.98
Also Available											
33 Gal.-Vertical 1.6-rhp Oil-Free Compressor	009-16762N◆	33	6.3	4.9	120	150	1/4	24.00 x 22.50 x 51.25	130	None	379.99
33 Gal.-Horizontal 1.6-rhp Oil-Free Compressor	009-16763N◆	33	6.3	4.9	120	150	1/4	40.88 x 17.66 x 35.00	119	None	379.99
C. 4 Gal.-1-rhp Induction Motor (Oil Lube) Twin Stack w/ Detachable Dolly	009-16638	4	3.7	2.4	120	125	1/4	20.00 x 20.47 x 25.91	84	17-pc. Accessory Kit w/ 25-ft. Coil Hose	179.99
D. 5 Gal.-Horizontal 1-rhp Induction Motor (Oil Lube) Contractor Cage Design w/ Detachable Dolly and Telescoping Handle	009-16636	5	3.7	2.4	120	125	1/4	20.28 x 20.28 x 27.68	75	17-pc. Accessory Kit w/ 25-ft. Coil Hose	199.99
E. 7 Gal.-Horizontal 1-rhp Induction Motor (Oil Lube)	009-16639	7	3.7	2.4	120	125	1/4	28.25 x 11.25 x 24.75	70	17-pc. Accessory Kit w/ 25-ft. Coil Hose	169.99
F. 12 Gal.-Vertical 1.6-rhp Induction Motor (Oil Lube)	009-16640	12	3.7	2.4	120	125	1/4	18.00 x 19.88 x 38.25	81	17-pc. Accessory Kit w/ 25-ft. Coil Hose	199.99
G. 20 Gal.-Vertical Compressor	009-16642	17	4.3	3.3	120	150	1/4	22.6 x 18.5 x 43	90	Accessory Kit and 25-ft. PVC Hose	249.99
Also Available 20 Gal.-Horizontal Compressor	009-16643	17	4.3	3.3	120	150	1/4	38.3 x 15.1 x 30.8	80	Accessory Kit and 25-ft. PVC Hose	249.99
H. 26 Gal.-Vertical Compressor	009-16770N◆	26	6.3	4.9	120	160	1/4	22.75 x 22.75 x 51.00	127	25-ft. 3/8 PVC Hose w/ Quick Connect & Plug	319.99
Also Available 26 Gal.-Horizontal Compressor	009-16771N◆	26	6.3	4.9	120	160	1/4	34.25 x 17.66 x 35.00	118	25-ft. 3/8 PVC Hose w/ Quick Connect & Plug	319.99

◆rhp = Running Horsepower †Catalog/Online EXCLUSIVE

CRAFTSMAN®



two-stage, oil-free 175 psi for optimal tool performance, our max. psi unit



3.2 rhp motor and oil lube pump supplies 150 max psi

two-stage oil lube twin-V pump for long life and durability



oil lube belt-driven compressor

CUSTOMER review

“Great compressor, and very friendly service from our Sears folks.”
CarpenterKid
Birmingham, AL

Craftsman Professional Air Compressors

Built to deliver years of high-powered service, these units feature oil-lubricated pumps, aluminum crankcases, cast iron cylinders, automotive pistons and compression rings.



Craftsman Professional Air Compressors and Combo Kits

Item	Description	Catalog Number	Tank, Gal.	SCFM @ 40 PSI	SCFM @ 90 PSI	Volts	Max PSI	Air NPT Outlet	Dimensions	Weight, lbs.	Price
A.	1.6 rhp 2-Stage Oil-Free Air Compressor	009-16778N◆	25	5.6	5.1	120	175	1/4	22.50 x 22.50 x 51.00	150	\$519.99
B.	1.8 rhp Oil-Lube Air Compressor	009-19541N◆	25	7.4	5.8	120/240	150	1/4	41.75 x 19.06 x 32.75	152	469.99
C.	3.2 rhp Oil-Lube Air Compressor	009-18419N◆	60	12.4	10.2	240	150	3/8 F	28.75 x 28.25 x 69.25	203	649.99
D.	5.4 rhp 2-Stage Oil-Lube Air Compressor	009-16781N◆	80	13.3 @ 100	12.8 @ 175	240	175	1/2 F	33.00 x 31.00 x 75.50	448	1,049.99

◆rhp = Running Horsepower

one-hand forward and reverse action



E



F



G



H

1/4 INCH DRIVE

lightweight composite tools (G & H) both feature built-in air regulator, 360° rear exhaust diffuser and silencing technology



J

3/8 INCH DRIVE

lightweight composite tool features 360° rear exhaust diffuser and silencing technology



L

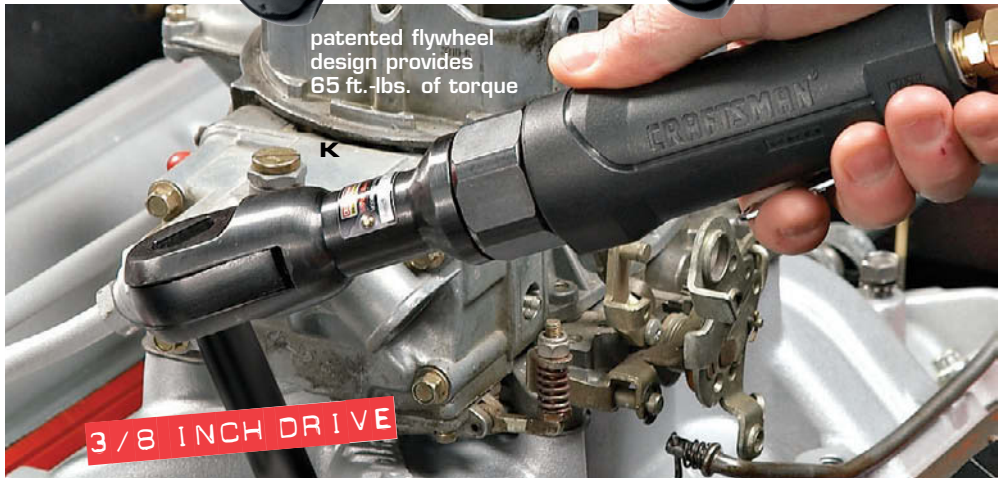

patented flywheel design provides 65 ft.-lbs. of torque

K

3/8 INCH DRIVE

1/2 INCH DRIVE

Craftsman Air Ratchets

Item	Description	Catalog Number	Brand	Drive Size, in.	Standard Bolt Size, in.	Length, in.	Average CFM Rating	Air Inlet NPT	Max. Torque, ft. lbs.	Weight, lbs.	Price
E.	3/8-in. Rapid Reverse Ratchet	009-19888	Craftsman Professional	3/8	3/8	10	3.4	1/4	50	2.5	\$149.99
F.	3/8-in. Ratchet	009-19933	Craftsman	3/8	3/8	10	4.0	1/4	50	2.3	69.99
G.	3/8-in. Mini Ratchet	009-19931	Craftsman	3/8	3/8	8	3.6	1/4	20	1.5	49.99
H.	3/8-in. Ratchet	009-19932	Craftsman	3/8	3/8	10	4.2	1/4	45	2.5	34.99
J.	1/4-in. Mini Ratchet	009-19930	Craftsman	1/4	1/4	8	3.6	1/4	20	1.5	49.99
K.	3/8-in. Ratchet	009-19919	Craftsman	3/8	3/8	10	3.3	1/4	65	2.4	99.99
Catalog/Online EXCLUSIVE											
L.	1/2-in. Ratchet	009-18819	Craftsman	1/2	1/2	14 1/2	6.0	1/4	70	4.3	129.99

M NEW

YOUR CHOICE, \$99.99



N NEW

FLORIDA PNEUMATIC

Florida Pneumatic® has been manufacturing air tools and related accessories for over 35 years. Our air tools have earned a reputation for superior quality and performance. At Florida Pneumatic, we provide a broad offering of tools focused on automotive car, truck, fleet and industrial service tools.

Catalog/Online EXCLUSIVE

M. NEW Florida Pneumatic® 1/4-inch Rapid Reverse Ratchet.

This rapid reverse ratchet features a quick reverse switch and built-in toggle regulator. Also features a 350 rpm run-down speed, flat head for improved access, a comfort grip and throttle lever and 30 ft.-lbs. of maximum torque. Extremely compact with rear exhaust. Wt. 1.25 lbs.

009-15091 99.99

Catalog/Online EXCLUSIVE

N. NEW Florida Pneumatic® 1/4-inch Stubby/Mini Ratchet.

Ultra compact design—only 5 inches long and weighs just 1 lb. It features a very fast 350 rpm run-down speed, a built-in air regulator, and a super-duty head design. Provides 25 ft.-lbs. of torque, and is designed specifically for use in extremely tight areas. Wt. 1 lb.

009-15093 99.99

*Warranted, see page 94a.
◆ See "N" suffix note on page 94a.

1/2-IN. DRIVE



- lightweight composite design
- silencing technology

A



- lightweight composite impact
- 700 ft.-lbs. of torque

B



- lightweight composite design

C



- built-in forward/reverse system
- silencing technology

D

1/2-IN. DRIVE



- 2-inch extended anvil

E



- 2-inch extended anvil

F



- great value!

G



- traditional steel housing design

H



SHOP ON THE GO!
 Visit sears2go.com on your mobile device

Craftsman Professional Impact Wrenches

Key	Catalog Number	Description	Brand	Drive Size, in.	Standard Bolt Size, in.	Length, in.	Average CFM Rating	Air Inlet NPT	Max. Torque, ft.-lbs.	Weight, lbs.	Price
A.	009-19984	1/2-inch Impact Wrench	Craftsman	1/2	1/2	7	4.7	1/4	580	4.5	\$129.99
B.	009-19864	1/2-inch Impact Wrench	Craftsman Professional	1/2	9/16	7	4.5	1/4	710	5.0	179.99
C.	009-19905	1/2-inch Impact Wrench	Craftsman Professional	1/2	9/16	7 1/8	3.9	1/4	600	4.5	189.99
D.	009-19983	1/2-inch Impact Wrench	Craftsman	1/2	1/2	7	4.5	1/4	400	5.3	89.99
E.	009-18852	Catalog/Online EXCLUSIVE 1/2-inch Extended Anvil Impact Wrench	Craftsman	1/2	1/2	9 1/2	4.5	1/4	500	5.7	159.99
F.	009-19915	Catalog/Online EXCLUSIVE 1/2-inch Extended Anvil Impact Wrench	Craftsman Professional	1/2	1/2	9 1/2	4.5	1/4	550	6.0	159.99
G.	009-19982	1/2-inch Impact Wrench	Craftsman	1/2	1/2	7	4.1	1/4	340	5.2	39.99
H.	009-19914	Catalog/Online EXCLUSIVE 1/2-inch Impact Wrench	Craftsman Professional	1/2	1/2	7 1/2	4.5	1/4	550	5.8	139.99

3/8-IN. DRIVE

1/4-IN. DRIVE



- lightweight composite design



- built-in forward/reverse
- silencing technology



- built-in air regulator
- swivel air inlet



- compact & powerful
- for small, delicate fasteners

AIR DRIVE TOOLS

3/4-IN. DRIVE



- 6-inch extended anvil



- lightweight composite design
- silencing technology



- lightweight composite design

1-IN. DRIVE



- our most powerful impact wrench with 1,200 ft.-lbs. of torque

Craftsman Impact Wrenches

Key	Catalog Number	Description	Brand	Drive Size, in.	Standard Bolt Size, in.	Length, in.	Average CFM Rating	Air Inlet NPT	Max. Torque, ft.-lbs.	Weight, lbs.	Price
J.	009-19916	3/8-inch Impact Wrench	Craftsman Professional	3/8	7/16	5 5/8	4.0	1/4	260	2.7	\$189.99
K.	009-19981	3/8-inch Impact Wrench	Craftsman	3/8	7/16	6 1/2	3.5	1/4	145	2.8	74.99
L.	009-19980	3/8-inch Butterfly Impact Wrench	Craftsman	3/8	7/16	7 1/4	3.6	1/4	95	2.0	59.99
M.	009-18854	Catalog/Online EXCLUSIVE 1/4-inch Impact Wrench	Craftsman	1/4	3/8	5 1/4	3.0	1/4	25	2.4	74.99
N.	009-18504	3/4-inch Extended Anvil Impact Wrench	Craftsman	3/4	1	14 1/2	7.0	1/4	700	13.2	359.99
P.	009-19985	3/4-inch Impact Wrench	Craftsman	3/4	1	9 1/2	5.2	3/8	750	8.0	249.99
Q.	009-18593	3/4-inch Impact Wrench	Craftsman Professional	3/4	1	8 1/4	9.5	3/8	900	7.0	449.99
R.	009-15090	Catalog/Online EXCLUSIVE 1-inch Impact Wrench	Craftsman	1	1 1/4	8 1/2	10.0	1/2	1,200	15.0	599.99
	Also Available 009-18507	Catalog/Online EXCLUSIVE 1-inch Extended Anvil Impact Wrench	Craftsman	1	1 1/4	20 1/2	9.5	1/2	1,200	32.8	499.99

*Warranted, see page 94a.
◆ See "N" suffix note on page 94a.

CRAFTSMAN®

PROFESSIONAL
AIR-POWERED SANDERS
AND DRILLS

HIGH SPEED



lightweight composite tool accepts 3-in. to 6-in. sanding discs

DUAL ACTION



3/16-in. orbital motion provides a professional swirl-free finish

STRAIGHT LINE



provides over 48 square inches of sanding surface



PALM SANDER

lightweight composite housing and built-in air regulator allows user to match the tool speed to the job.

Check online for
SALE PRICING!

1/2-IN. DRILL



powerful 1/2-in. design



professional grade 1/2-in. power

G



90-degree head design allows for operation in tight spaces

3/8-IN. DRILL



lightweight, composite design



keyless Jacobs chuck

Craftsman® and Craftsman® Professional Air Tools

Item	Catalog Number	Description	Brand	Pad Diameter, in.	Chuck Size, in.	Free Speed Strokes Per Minute	Length, in.	Average CFM Rating	Air Inlet NPT	Weight, lbs.	Price
A.	009-19965	High Speed Sander	Craftsman	6	N/A	13,000	6 1/2	4.3	1/4	2.0	\$49.99
B.	009-19976	Dual Action Sander	Craftsman	6	N/A	10,000	10 1/2	3.1	1/4	3.5	69.99
C.	009-18970	Catalog/Online EXCLUSIVE Straight Line Sander	Craftsman	2 3/4 x 17 1/2	N/A	2,600	17 1/2	5.0	1/4	5.5	119.99
D.	009-19960	Palm Sander	Craftsman	6	N/A	12,000	6	3.1	1/4	2.2	99.99
E.	009-18892	Catalog/Online EXCLUSIVE 1/2-in. Drill	Craftsman	N/A	1/2	500	7 1/2	4.0	1/4	3.0	129.99
F.	009-19912	Catalog/Online EXCLUSIVE 1/2-in. Drill	Craftsman Professional	N/A	1/2	800	7 3/4	5.0	1/4	4.0	199.99
G.	009-18514	Catalog/Online EXCLUSIVE 3/8-in. Right Angle Drill	Craftsman	N/A	3/8	1,800	8	5.0	1/4	2.7	104.99
H.	009-19950	3/8-in. Drill	Craftsman	N/A	3/8	2,200	6 1/2	3.3	1/4	2.1	79.99
J.	009-19904	Catalog/Online EXCLUSIVE 3/8-in. Drill	Craftsman Professional	N/A	3/8	2,200	7	5.0	1/4	2.6	169.99

1/4-IN. GRINDERS



360° rotating exhaust diffuser & 5-to-4 gear reduction for added power



precision 3-piece collet



clear shield protector

DIE GRINDER



includes 7 carbide burs & blow-mold carrying case



powerful 11,000 rpm 4-inch design

ANGLE GRINDERS



7-inch design



professional powered 12,000 rpm 5-inch design

Craftsman® and Craftsman® Professional Air Drive Grinders and Cut-Off Tools

Item	Catalog Number	Description	Brand	Collet	Wheel Size, in.	Arbor Bolt Size, in.	Free Speed/Size, in.	Length, Strokes per Minute (RPM/SPM)	Average in.	Air Inlet CFM Rating	Weight, NPT	Price lbs.
K.	009-19951 Also Available 009-16410	1/4-in. Right Angle Die Grinder	Craftsman	1/4	N/A	N/A	20,000	4 3/4	3.7	1/4	1.1	\$69.99
		2-pc. Sanding Disc Assortment	Craftsman						3.7			0.0
L.	009-19952 Also Available 009-16046	1/4-in. Straight Die Grinder	Craftsman	1/4	N/A	N/A	20,000	4 3/4	4.0	1/4	1.4	59.99
		3-pc. Carbide Bur Set. Includes: Cylindrical shape, Ball shape, Round nose tree shape	Craftsman						4.0			.28
M.	009-19953 Also Available 009-18834	Cut-Off Tool	Craftsman	N/A	2 7/8	3/8	20,000	7	3.9	1/4	1.75	69.99
		Cut off Wheels, 6 pk.	Craftsman						3.9			0.0
N.	009-19025	Catalog/Online EXCLUSIVE Die Grinder Kit	Craftsman	1/4	N/A	N/A	22,000	6 5/8	6.5	1/4	3	159.99
P.	009-18811 Also Available 009-18851	Catalog/Online EXCLUSIVE 4-in. Angle Grinder	Craftsman	N/A	4	3/8 x 24	11,000	8 3/4	7	1/4	4	149.99
		4-in. Grinding Wheel, 2 pk.	Craftsman									.28
Q.	009-18560	Catalog/Online EXCLUSIVE 7-in. Angle Grinder	Craftsman	N/A	7	5/8 x 11	4,500	12 3/4	7	1/4	5.6	329.99
R.	009-19911 Also Available 009-18537	Catalog/Online EXCLUSIVE 5-in. Angle Grinder	Craftsman	N/A	4 1/2 to 5	5/8 x 11	12,000	8 7/8	7	1/4	4.9	239.99
		5-in. Grinding Wheels, 2 pk.	Craftsman									.82



AIR-DRIVEN POWER



IMPACT HAMMER
lightweight,
delivers 3,000 bpm



CHIPPING HAMMER
2, 3 and 4-inch models use
standard .680 oval shank chisel



HEAVY-DUTY RIVET GUN
provides 3,200 lbs.
of pull on 3/16 and
1/4-inch aluminum
rivets



STANDARD RIVET GUN
provides 2,000 lbs. of pull
on 1/8, 5/32 and 3/16-inch
aluminum rivets



E
cuts up to
16-gauge steel

F
7/32-inch cutting width
cuts squares and circles

CUTTING TOOLS

G
360-degree
rotational handle
recoilless design provides
smooth, quiet operation

MORE TO EXPLORE
at sears.com!

Item	Catalog Number	Description	Brand	Stroke Length, in.	Shank Size/ Jaw Size/ Cut Width, in.	Strokes per Minute/ Pounds of Pull (SPM/POP)	Length, in.	Average Air Consumption	Air Inlet NPT	Weight, lbs.	Price
A.	009-19026	Catalog/Online EXCLUSIVE 4-bolt Chipping Hammer	Craftsman	2	.680	2,300	14	10	3/8	18	\$459.99
	009-19027	Catalog/Online EXCLUSIVE 4-bolt Chipping Hammer	Craftsman	3	.680	2,100	15 1/4	10	3/8	19	479.99
	009-19028	Catalog/Online EXCLUSIVE 4-bolt Chipping Hammer	Craftsman	4	.680	1,700	16 1/2	10	3/8	20	499.99
B.	009-19897	Impact Hammer	Craftsman	2 5/8	.401	3,000	7 1/2	3.2	1/4	3.25	39.99
	009-18687	4-piece Chisel Set	Craftsman							1.4	25.99
C.	009-19890	Catalog/Online EXCLUSIVE Heavy-Duty Rivet Gun	Craftsman	3/4	3/16, 1/4	3,200 (POP)	12 1/4	1	1/4	5.35	399.99
D.	009-18561	Catalog/Online EXCLUSIVE Standard-Duty Rivet Gun	Craftsman	3/4	1/8, 5/32, 3/16	2,000 (POP)	11 1/4	1	1/4	4.75	169.99
E.	009-19913	Catalog/Online EXCLUSIVE Recoilless Air Saw 360-degree rotational handle	Craftsman Professional	3/16	N/A	9,000	8	2	1/4	2.5	229.99
F.	009-19014	Catalog/Online EXCLUSIVE Air Shear	Craftsman	7/32	7/32	2,800	8 1/2	4	1/4	2.75	189.99
G.	009-19015	Catalog/Online EXCLUSIVE Air Nibbler	Craftsman	7/32	7/32	2,600	7	4	1/4	2.25	199.99

Catalog/Online EXCLUSIVES (More Sizes Online!)

H-P. Mechanix Wear® Gloves.

- H. Men's Original Gloves.** Large shown. Wt. 0.3 oz.
 009-40226-010 Blue.....24.99
 009-40223-010 Red.....24.99
 009-47601-000 Black.....24.99
 009-40235-010 Wood Camouflage.....24.99
 009-40232-010 Coyote.....24.99
 009-40220-010 Yellow.....24.99
J. NEW Women's Original Gloves. Medium shown. Wt. 0.3 oz.
 009-82973-009 Pink Camouflage.....19.99
 009-82974-009 Black.....19.99
K. Women's Utility Gloves. Medium shown. Wt. 0.3 oz.
 009-40211-520 Maroon.....15.99
 009-40250-520 Sage.....15.99
L. NEW M-PACT Gloves. Large shown. Wt. 0.34 oz.
 009-47700-010 Black.....39.99
M. CG Utility Gloves. Large shown. Wt. 0.2 oz.
 009-40290-010 Black.....20.99
N. CG Padded Palm Gloves. Large shown. Wt. 0.28 oz.
 009-40293-010 Black.....30.99
P. CG Impact Pro Gloves. Large shown. Wt. 0.3 oz.
 009-50581-000 Black.....39.99

Catalog/Online EXCLUSIVE

- Q-V. Ironclad® Gloves.** Large shown. Other sizes available online.
Q. NEW IVO I-VIZ Utility Gloves. Wt. 0.5 oz.
 009-83043-010 Safety Orange.....19.99
 009-83044-010 Safety Green.....19.99
R. Workforce Utility Gloves. Wt. 0.2 oz.
 009-48069-000 Gray/Black.....17.99
S. Framers' Gloves. Wt. 0.25 oz.
 009-48061-000 Gray/Black.....29.99
T. Ranchworx® Gloves. Wt. 0.35 oz.
 009-40255-000 Black/Tan.....39.99
U. NEW Tundra Gore-Tex® Gloves. Wt. 0.35 oz.
 009-87686-010 Black/Gray.....79.99
V. NEW Cold Condition® Waterproof Gloves. Wt. 0.35 oz.
 009-87687-010 Black/Gray.....39.99

W-Z. Craftsman® Mechanic's Gloves.

- Other sizes available online.
W. Mechanic's Utility Gloves. Extra-Large shown. Wt. 0.24 oz.
 009-47551-000 Black.....14.99
X. Mechanic's Gloves. Large shown. Wt. 0.28 oz.
 009-47553-000 Black.....19.99
 009-47556-000 Red.....19.99
Y. Professional Mechanic's Gloves. Large shown. Wt. 0.28 oz.
 009-47559-000 Black.....24.99
Z. Professional Carpenter's Gloves. One size fits all. Wt. 0.28 oz.
 009-18220 Black.....24.99



Catalog/Online EXCLUSIVE

- AA-EE. ALL NEW DeWalt® High-Performance Protective Gear.** A comprehensive line of quality DeWalt® licensed protective gear including eyewear, hearing protection, flashlights and accessories. Innovative styles, lens colors and magnifications to suit any need. All DeWalt® glasses are produced in ISO certified facilities and meet or exceed ANSI Z87.1+ standards. Hearing protectors are tested with ANSI S3.19-1974 standards. See full line at sears.com/shoptools.
AA. Reinforcer™ RX Clear 1.0 Safety Glasses. With magnification lens. Model DPG59-110C. Wt. 0.45 oz.
 009-90971.....19.99
BB. Reinforcer™ TX Smoke Safety Glasses. With magnification lens. Model DPG59-245C. Wt. 0.45 oz.
 009-90993.....19.99
CC. All-Purpose Synthetic Leather Gloves. Model DPG20L. Wt. 0.35 oz. Large shown.
 009-90937-010.....14.99
DD. Interceptor Folding Earmuff. Adjustable. Model DPG62-C. Wt. 1.88 lbs.
 009-92002.....27.99
EE. Aluminum LED Flashlight. 141 lumens. Model DPGA-3CCS. Wt. 1.34 lbs.
 009-91106.....64.99



AIR DRIVE TOOLS & ACCESSORIES

*Warranted, see page 94a.
 ♦ See "N" suffix note on page 94a.

Dual-Mark Sockets

All Craftsman impact sockets on these pages feature large Dual-Mark markings for easy identification, even in low lighting. Dual-markings resist fading. Although rigorous use may wear off the black oxide coating, making laser etching more difficult to read, sockets also feature hard stamped markings for lasting visibility.



CRAFTSMAN®

IMPACT SOCKETS



Catalog/Online EXCLUSIVE
F. Craftsman 55-piece 1/2-in. Drive Dual-Mark Impact Socket Set. This set features all-inclusive 1/2-inch drive impact tools. Includes 12 inch sockets (3/8 thru 1 1/16 in.), 12 metric sockets (12 thru 19, 21, 22, 24 and 27 mm), 12 inch deep sockets (3/8 thru 1 1/16 in.), 12 metric deep sockets (12 thru 19, 21, 22, 24 and 27 mm), universal joint, swivel universal joint, 3, 6 and 10 inch extension bars, 3/8 inch adapter and 3/4 x 13/16 double-end socket. Separate prices total \$576.85. Warranted*. Made in USA. Wt. 26.7 lbs. **009-83127249.99**

Catalog/Online EXCLUSIVE
H. Craftsman 27-piece 1/2-inch Dual-Mark Inch Impact Socket Set. A broad selection of our most popular sizes. Includes 12 6-point inch sockets (3/8 thru 1 1/16 in.), 12 6-point inch deep sockets (3/8 thru 1 1/16 in.), two extension bars (3, 6 in.) and 3/8-inch impact adapter. Separate prices total \$260.43. Made in USA. Wt. 13 lbs. **009-23763139.99**

Also Available
Craftsman 27-piece 1/2-inch Dual-Mark Metric Impact Socket Set. Includes 12 metric sockets (12 thru 19, 21, 22, 24 and 27 mm), 12 metric deep sockets (12 thru 19 and 21, 22, 24 and 27 mm), 3 and 6 inch extension bars and one universal joint. Separate prices total \$263.93. Made in USA. Wt. 13 lbs. **009-23764139.99**



G. Craftsman 7-piece 1/2-inch Drive Dual-Mark Impact Deep Lug Nut Set. Our most popular sizes that fit most lug nuts. Set includes 1/2-inch drive socket sizes 13/16, 7/8, 3/4, 15/16 in. and 17 and 19 mm. Also includes 6 in. extension bar. Separate prices \$81.93. Made in USA. Wt. 4.8 lbs. **009-1535939.99**



1/2-inch and 3/8-inch socket adapters available online



Catalog/Online EXCLUSIVE
J. Craftsman 24-piece 1/2-inch Drive Dual-Mark 6-point Impact Socket Set. This set features the most popular sizes of all Dual-Mark regular impact sockets in both inch and metric sizes. Strong enough for those tough jobs. Includes sizes 3/8 thru 1 1/16 in. and metric sizes 12 thru 19, 21, 22, 24, 27 mm. Separate prices total \$195.16. Made in USA. Wt. 17.5 lbs. **009-15357109.99**



Catalog/Online EXCLUSIVE
K. Craftsman 24-piece 1/2-inch Drive Dual-Mark 6-point Deep Impact Socket Set. This set features all deep sockets in both inch and metric sizes to reach fasteners in tight spaces. Each socket has the size laser-etched for easy identification. Includes sizes 3/8 thru 1 1/16 in. and metric sizes 12 thru 19, 21, 22, 24, 27 mm. Separate prices total \$264.26. Made in USA. Wt. 16.8 lbs. **009-15356159.99**

Catalog/Online EXCLUSIVE
L. Craftsman 2-piece Dual-Mark Swivel Universal Impact Adapter Set. Pinless swivel design provides flexibility. Includes 3/8 and 1/2-inch adapter. Separate prices total \$79.98. Made in USA. Wt. 1.03 lbs. **009-1536959.99**

*Warranted, see page 94a.
 ◆ See "N" suffix note on page 94a.



CRAFTSMAN®

Catalog/Online EXCLUSIVE

A. Craftsman 22-piece 1-inch Drive Impact Socket Set. This set features our largest impact sockets yet to tackle the heaviest of jobs! 1-inch set includes 1, 1 1/16, 1 1/8, 1 1/4, 1 5/16, 1 3/8, 1 7/16, 1 1/2, 1 5/8, 1 11/16, 1 3/4, 1 13/16, 1 7/8, 2, 2 1/16, 2 3/16, 2 1/4, 2 3/8, 2 9/16, 2 5/8, 2 3/4, 3 in. sockets. Separate prices total \$1,712.78. Made in USA. Wt. 65.3 lbs.

009-15052 999.99

MORE 1-INCH DRIVE IMPACT SETS AT SEARS.COM/SHOOTOOLS

Catalog/Online EXCLUSIVE

B. Craftsman 20-piece 3/4-inch Drive Inch Impact Socket Set. Features all 3/4-inch drive sockets with dual-size marking stamped and laser-etched for easy identification. Sizes include 3/4, 13/16, 7/8, 15/16, 1, 1 1/16, 1 1/8, 1 3/16, 1 1/4, 1 5/16, 1 3/8, 1 7/16, 1 1/2, 1 5/8, 1 11/16, 1 3/4, 1 13/16, 1 7/8, 1 15/16, 2 in. Separate prices total \$839.80. Made in USA. Wt. 26.7 lbs.

009-18792 349.99

Also Available

Craftsman 12-piece 3/4-inch Dual-Marked Metric Impact Socket Set. Sizes include 19 thru 24, 27, 30, 32, 36, 41, 46 mm. Separate prices total \$394.88. Made in USA. Wt. 12.6 lbs.

009-18794 199.99



SWIVEL IMPACT SETS

SWIVEL IMPACT SOCKETS HAVE GREATER FLEX ACCESS, UP TO 360°

Catalog/Online EXCLUSIVE

G. Craftsman 16-piece 3/8-inch 6-point Dual-Mark Swivel Impact Socket Set. Pinless swivel design for enhanced strength and life. Features a greater flex angle for access and speed. Spherical ball design distributes torque loads evenly. Smaller, tighter joint diameter enables improved range of motion for easier access to tight areas. Features sizes 3/8, 7/16, 1/2, 9/16, 5/8, 11/16, 3/4 in. and metric 10 thru 18 mm. Made in USA. Wt. 4.8 lbs.

009-15360 349.99

H. Craftsman 7-piece 3/8-inch Drive Swivel Dual-Mark Inch Set. Includes sizes 3/8, 7/16, 1/2, 9/16, 5/8, 11/16 and 3/4 inch. Wt. 1.9 lbs.

009-15396 179.99

Also Available

9-piece 3/8-inch Drive Metric Set. Includes sizes 10 thru 18 mm. Wt. 2.4 lbs.

009-15397 229.99

J. 8-piece 1/2-inch Drive Swivel Dual-Mark Inch Set. Includes sizes 1/2, 9/16, 5/8, 11/16, 3/4, 13/16, 7/8 and 15/16 inch. Wt. 3.9 lbs.

009-15391 269.99

Also Available

9-piece 1/2-inch Drive Swivel Dual-Mark Metric Set. Includes sizes 13 thru 19, 21 and 22 mm. Wt. 4.4 lbs.

009-15390 299.99

pinless design provides enhanced strength

helical spring for long life

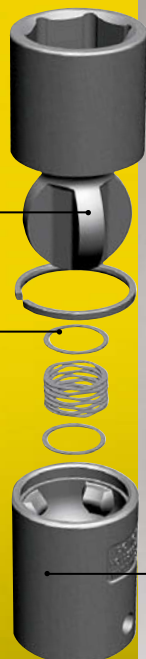

unique multi-spherical contact points distribute loads evenly



Campbell Hausfeld Professional Use Extreme Duty Compressors

Built to perform in high-demand applications, these compressors provide dependable service at quiet noise levels. Units feature:

- Cast iron, oil-lubricated pumps for heavy-duty operation
- ASME Code tanks to assure safe operation
- Factory installed motor starter on 7.5- and 10-hp models



60 GALLON

A

30 GALLON



E

2-stage horizontal units



B

80 GALLON

C



D

120 GALLON



F

2 GALLON



G

26 GALLON

Campbell Hausfeld Air Compressors Catalog/Online EXCLUSIVE

Item/ Catalog Number	Description	Running HP	Tank Gal. (L)	Volts/ Phase	SCFM @ 90 PSI	SCFM @ 175 PSI	MAX PSI	Weight, lbs.	Air NPT outlet, in.	Price
A. 009-88719N◆ (Model #VT6275)	60-gallon Oil-Lubricated Vertical Air Compressor	3	60	230v, 1 ph	10.2 SCFM	—	135	251	3/4	\$699.99
B. 009-16625N◆ (Model #CI071080VMS)	Two Stage 7.5 HP Vertical Air Compressor, Motor Starter	7.5	80	230v, 1 ph	23.7 SCFM	22.2 SCFM	175	525	3/4	1,749.99
C. 009-16619N◆ (Model #XP5810)	Two Stage, 5.0 HP Vertical Air Compressor	5	80	230v, 1 ph	14.6 SCFM	14.1 SCFM	175	501	3/4	1,149.99
D. 009-16611N◆ (Model #CI103120HMS)	Two Stage, 10.0 HP Horizontal Air Compressor, Motor Starter	10	120	230v, 3 ph	37.6 SCFM	35.2 SCFM	175	845	1	2,599.99
E. 009-16627N◆ (Model #CH12G030H)	Two Stage 12.5 HP Horizontal Air Compressor, Kohler Engine	12.5	30	—	23.0 SCFM	22.0 SCFM	175	520	1/2	2,299.99
F. 009-16613 (Model #FP2095)	Two-gallon Air Compressor	1	2	120v	0.39 SCFM	—	100	60	1/4	139.99
G. 009-16618N◆ (Model #WL-8027)	Single-Stage Low-Rider Air Compressor	1.8	26	120v	4.5 SCFM	—	150	150	1/4	489.99

KAESER COMPRESSORS

Built for a lifetime.

Kaeser Airtowers

Providing reliable industrial performance for high-demand applications, Kaeser Airtowers are German engineered for reliability, long-life and super-quiet operation. With less than half the noise level of piston units and a compact footprint, these complete rotary screw compressor packages can be placed virtually anywhere. Each features a precision machined rotary screw air end with no rings or seals to wear out. With a lightweight molded polymer cover for quick and easy access, all compressors feature a complete compressed air system with built-in refrigerated dryer, drain trap and tank for clean, dry air. Vibration-free operation. Freight and factory-trained set-up are included in price. 2-year warranty with factory start-up.



perfect for multiple user environments

PRICES INCLUDE FREIGHT AND FACTORY-TRAINED SET-UP

SHOP ON THE GO!
Visit sears2go.com on your mobile device

AIR COMPRESSORS

H. NEW Kaeser Industrial Compressors											
Sears Item	Model Number	Running HP	Max. Air Pressure	Receiver Tank (gal)	Voltage	CFM at 125 PSI	CFM at 160 PSI	Air NPT Outlet (in NPT)	Wt. (lbs.)	Package Dimensions (in.)	Price
009-82882	Airtower 4C - 125	4	125	56.8	208-230/460V/3ph/60Hz	15.9	—	3/4	628	24.4 x 38.6 x 58.3	\$6,999.99
009-82883	Airtower 4C - 160		160			12.7	7,399.99				
009-82884	Airtower 5C - 125	5	125	56.8	208-230/460V/3ph/60Hz	21.2	—	3/4	639	24.4 x 38.6 x 58.3	7,399.99
009-82885	Airtower 5C - 160		160			17	7,799.99				
009-82886	Airtower 7.5C - 125	7.5	125	56.8	208-230/460V/3ph/60Hz	28.3	—	3/4	639	24.4 x 38.6 x 58.3	7,899.99
009-82887	Airtower 7.5C - 160		160			18.7	8,299.99				

Universal Air Tools

Feature state of the art design, the highest horsepower motors in their class and unparalleled reliability for continuous heavy-duty industrial applications.

Catalog/Online EXCLUSIVE
J & K NEW Universal® 3/8 and 1/2-inch Reversible Drills. For high-volume drilling applications, these 0.9 hp reversible drills features fully caged gears with needle bearings and ported throttle valve for reliability and control, thru-handle exhaust and built-in silencing. Features an ergonomic "Softouch" coating for comfort and a durable high-performance Jacobs® industrial chuck. 3/8-in. drill develops 1,800 rpm, 1/2-in. drill 400 rpm.
J. 3/8-Inch Reversible Drill. Wt. 1 lb.
 009-82900.....299.99
K. 1/2-Inch Reversible Drill.
 Wt. 1.5 lbs.
 009-82901.....389.99

Catalog/Online EXCLUSIVE
L. NEW Universal® 4 1/2 and 5-inch Angle Grinder Grinder accepts both 4 1/2 and 5 inch grinding wheels. The 1.25 hp motor is governor-controlled to provide even speeds under load. Features include a safety lock off-throttle and reliable heavy-duty spiral gears. Composite grip for vibration-free comfort and versatile left or right-handed side handle set-up. Develops 11,000 rpm for heavy grinding and MRO applications. Wt. 4.8 lbs.
 009-82902.....469.99

Catalog/Online EXCLUSIVE
M. NEW Universal® 7-inch Angle Grinder. A powerful 1.7 hp motor generates 7,500 rpm for continuous heavy-duty surface prep and material removal. In addition to the one-piece housing and durable heavy-duty air cooled gears and double bearings, this unit features a safety lock-off throttle, composite grip for vibration-free comfort and versatile left- or right-handed side handle set-up. Wt. 6.9 lbs.
 009-82904.....619.99

Catalog/Online EXCLUSIVE
N & P. NEW Universal® Heavy Duty Die Grinder and Angle Die Grinder. Both precision engineered models rely on a solid 0.9 hp motor to generate extra stall-resistant power. With safety lock-off throttles, rear exhaust and ergonomic and comfortable "Softouch" finish, the HD Grinder develops 22,000 rpm; while the Angle Grinder, with its smooth operating, spiral machined bevel and pinion gears, generates 18,000 rpm.
N. Heavy-Duty Die Grinder. Wt. 1.5 lbs.
 009-82905.....189.99
P. Angle Die Grinder. Wt. 1.6 lbs.
 009-82906.....299.99



Type 30 Ingersoll Rand Compressors

Classic Type-30 air compressors have been providing unsurpassed performance in the most demanding industrial applications for over 75 years. Built for durability and extended life.

WHY INGERSOLL RAND

- 100% cast iron pump for durability
- 100% continuous-duty rating—designed to run 24 hours a day
- Two-year warranty with use of Ingersoll Rand start-up kit
- 175 maximum PSI for greater storage capabilities
- Classic twin piston “V-style” pump design for cool operation
- Nationwide service coverage

STANDARD PACKAGE FEATURES

- Industrial-grade ODP motor
- ASME-rated storage tank
- High-efficiency intercooler
- Magnetic motor starter
- 175 maximum PSI

“FULLY-PACKAGED” MODELS ALSO INCLUDE:

- Low-oil-level switch—protects pump from running in a low-oil condition
- Air-cooled after-cooler—removes approximately 70% of moisture from the air
- Electronic drain valve (110 volt)—automatically drains water from the tank

100% duty cycle motor



SINGLE-STAGE
portable,
4.5 twin gallon



SINGLE-STAGE GAS



TWO-STAGE GAS

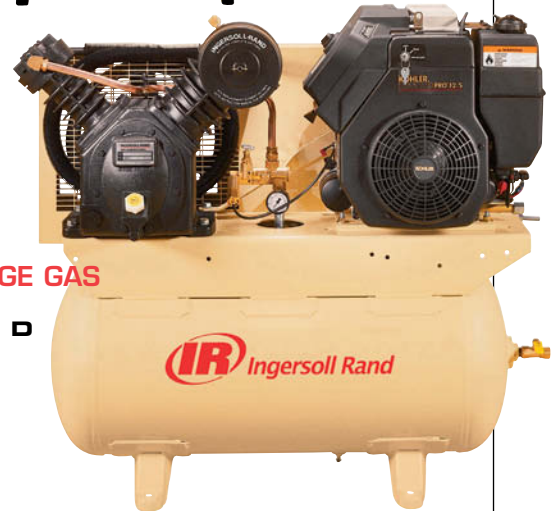

ALL NEW

SEE MORE OF INGERSOLL RAND COMPRESSOR PACKAGES AT WWW.SEARS.COM/SHOOTOOLS

Catalog/Online EXCLUSIVE

A. NEW Ingersoll Rand® Two-Stage 7.5 hp Air Compressor. For multi-user applications, the continuous-duty Type 30 pump delivers 24.3 cfm at 90 psi and 175 psi maximum. Magnetic starter, V-belt drive, 230V – single phase motor. Other voltages available. Warranted*. Wt. 500 lbs.
009-19260..... **2,399.99**

Catalog/Online EXCLUSIVE

B. NEW Ingersoll Rand® Twin-Stack Air Compressor. A portable compressor that's powerful, durable and designed for a 100% continuous-duty jobsite application. 4.5 gal. twin tanks, universal coupler, regulator, pressure gauge, lubricant and power cord. Wt. 58 lbs.
009-19688..... **329.99**

Catalog/Online EXCLUSIVE

C. NEW Ingersoll Rand® Single-Stage Gas Driven 5.5 hp Honda Air Compressor. This low-profile wheelbarrow-style design delivers maximum flexibility in any continuous application. Includes V-belt drive, pressure switch, regulator, gauge, two quick disconnects and twin 8 gal. tanks. Wt. 175 lbs.
009-19687..... **899.99**

Catalog/Online EXCLUSIVE

D. NEW Ingersoll Rand® Two-Stage Gas-Driven 13 hp Kohler Air Compressor. Designed for rugged mobile vehicle continuous-duty service. The Type 30 pump delivers 25 cfm at 90 psi and 175 psi maximum. Includes electronic ignition, idle engine control, 30-gal. ASME receiver, V-belt drive and weather-resistant powdercoat finish. Warranted*. Wt. 425 lbs.
009-19686N◆..... **2,299.99**

Catalog/Online EXCLUSIVE

E. Ingersoll Rand 3/8-inch Titanium Duty Air Impactool™. Lightweight and compact, this impressive tool measures six inches long and weighs less than two and a half pounds, allowing greater access to tight spaces, while reducing operator fatigue. Delivers 300 ft.-lbs. of torque and 1,500 bpm. Features titanium case, twin hammer mechanism and feather-touch trigger. Wt. 2.48 lbs.

009-82915299.99

F. Ingersoll Rand Die Grinder Kit. This grinding set features all the tools needed to detail any project. Complete with angle die grinder and straight die grinder. Set also includes five grinding stones, 2 and 3-inch quick-change backing pads, conditioning and sanding discs and more. Wt. 3 lbs.

009-1955999.99

G. NEW Ingersoll Rand 20-gallon 2 hp Compressor. This versatile unit features a cast iron, oil-lubricated pump for solid, reliable performance. Belt-driven for quiet operation. Delivers 135 psi max. with 5.5 cfm at 90 psi. Equipped with fully-pneumatic tires, heavy-duty handle, a pressure switch, pressure gauge, regulator, safety valve, manual drain and 6-foot power cord. Regular price \$529.99. Wt. 90.7 lbs.

009-89225499.99

Catalog/Online EXCLUSIVE

H. NEW Ingersoll Rand 3/8-In. Reversible Drill. Keyless chuck for quick bit replacement. Contoured grip and trigger. Handle exhaust directs air away from work area. Wt. 2.7 lbs.

009-1511099.99

Catalog/Online EXCLUSIVE

J. Ingersoll Rand Air Hammer with Quick Change and Chisel Set. Delivers 3,500 blows per minute. Built-in power regulator. Professional touch trigger and handle control design. Comes with 3-piece chisel set. Wt. 3.5 lbs.

009-1511149.99

Catalog/Online EXCLUSIVE

K. Ingersoll Rand 1/2-In. Composite Quiet Impact Wrench. Provides 600 ft.-lbs. of torque. Lightweight composite housing with twin hammer for long tool life. Features quiet tool technology. Wt. 5.25 lbs.

009-15101189.99

Catalog/Online EXCLUSIVE

L. Ingersoll Rand 3/4-In. Ultra-Duty Air Impact Wrench. This mighty wrench weighs only 7 pounds, yet delivers 1,200 ft.-lbs. torque. Features 360-degree swivel inlet. Twin hammer mechanism ensures extended tool life. Wt. 7 lbs.

009-18584499.99



SEARS.COM/SHOPTOOLS
Sign up to be notified when items go on sale.

Catalog/Online EXCLUSIVE

M. Ingersoll Rand 3/8-In. High-Power Air Ratchet. Enhanced mechanism develops 300 rpm. Delivers up to 70 ft.-lbs. of torque. Double pawl head design resists skipping and spreading. Features 360-degree adjustable exhaust, comfortable handle and button throttle. Warranted. Wt. 3.1 lbs.

009-18821149.99

Catalog/Online EXCLUSIVE

N. NEW Ingersoll Rand 1/2-In. Air Ratchet Wrench. Features optimized gear ration and airflow, and twin pawl plus head design. Offers 76 ft.-lbs. maximum torque at 220 rpm free speed. Includes a variable speed button trigger and 360-degree adjustable exhaust. Wt. 3.1 lbs.

009-89230169.99



G NEW



H NEW

600 ft.-lbs. of torque and exclusive quiet technology!

N NEW

*Warranted, see page 94a.
♦See "N" suffix note on page 94a.

IMPACT WRENCHES



**RICH EVANS—
MASTER FABRICATOR,
WELDER & PAINTER**

Chicago Pneumatic Impact Wrenches – 3/4-in. and 1-in. Drive **Catalog/Online EXCLUSIVES**

Item	Catalog Number	Model Number	Description	Max. Torque	SCFM at 90 psi	Wt., lbs.	Features	Price
A.	009-19701	CP7774	Heavy-Duty 1-in. Air Impact Wrench	1,200 ft.-lbs.	8.75	22.2	Three-position forward/reverse power regulator, handle directs exhaust away from operator.	\$799.99
B.	009-18260	CP772H	Extra Heavy-Duty 3/4-in. Air Impact Wrench	1,000 ft.-lbs.	6	10.5	Smooth operating clutch. Four-position power regulator, push-button forward/reverse, handle exhaust contoured grip.	399.99
C.	009-19699	CP7763	Professional-Duty 3/4-in. Air Impact Wrench	950 ft.-lbs.	7.5	13.7	Smooth operating clutch. Four-position forward power regulator, push-button forward/reverse, handle exhaust, contoured grip.	479.99
D.	009-19700	CP7775-6	Super-Duty 1-in. Air Impact Wrench, 6-in. Anvil	1,550 ft.-lbs.	8.75	28.2	High torque, lightweight and durable. Ergonomic trigger and handle directs exhaust away from operator, four-position power control.	799.99



Depend on Chicago Pneumatic for innovative, lightweight and durable cordless impact tools.

TONY'S PICK

Chicago Pneumatic Impact Wrenches – 1/2-inch Drive **Catalog/Online EXCLUSIVES**

Item	Catalog Number	Model Number	Description	Max. Torque	SCFM at 90 psi	Wt., lbs.	Features	Price
E.	009-18257	CP734H	Heavy-Duty 1/2-in. Air Impact Wrench	425 ft.-lbs.	3.75	5.1	Oil bath clutch for smooth operation. Four-position power regulator, push-button forward/reverse button, handle exhaust.	\$104.99
F.	009-18263	CP749	Super-Duty 1/2-in. Air Impact Wrench	625 ft.-lbs.	5.5	5.5	Smooth operating spring hammer clutch. Four-position power regulator, push-button forward/reverse, handle exhaust.	179.99
G.	009-18264	CP749-2	Super-Duty 1/2-in. Air Impact Wrench 2-in. Anvil	625 ft.-lbs.	5.7	5.75	Smooth operating spring hammer clutch. Four-position power regulator, push-button forward/reverse, handle exhaust.	179.99
H.	009-19697	CP7740	Lightweight 1/2-in. Air Impact Wrench	500 ft.-lbs.	5.25	2.7	Lightweight, durable magnesium housing and motor system. Ergonomic rubber grip, three-position power regulator and push-button forward/reverse.	319.99
J.	009-18268	CP7750	Turbo 1/2-in. Air Impact Wrench	800 ft.-lbs.	6	2.8	Patented CP turbo motor with four-position power regulator – 2 forward, 2 reverse. Professional touch trigger, ergonomic cushion grip, handle exhaust.	249.99



Chicago Pneumatic Ratchet Wrenches **Catalog/Online EXCLUSIVES**

Item	Catalog Number	Model Number	Description	Max. Torque	SCFM at 90 psi	Wt., lbs.	Features	Price
K.	009-19670	CP826	1/4-in. Air Ratchet	15 ft.-lbs.	4.25	1.1	Extended length design is ideal for confined workspaces.	\$169.99
L.	009-19702	CP7823	1/4-in. Swivel Head Air Ratchet	15 ft.-lbs.	4.5	1.0	Four-position swivel head, compact design, rear exhaust, 250 rpm.	169.99
M.	009-18269	CP7830Q	Super-Duty 3/8-in. Air Ratchet	90 ft.-lbs.	5	2.7	Adjustable noise control – as low as 79 dBA. Lightweight, well-balanced, features new TriSpring anti-slip head, virtually eliminates slippage and improves durability.	179.99
N.	009-19703	CP7830HQ	Super-Duty 1/2-in. Air Ratchet	90 ft.-lbs.	5	2.7	Adjustable noise control – as low as 79 dBA. Lightweight, well-balanced, features new TriSpring anti-slip head, virtually eliminates slippage and improves durability.	199.99

quiet...only 0.79 dB at high torque (up to 90 ft.-lbs.), TriSpring® anti-slip head design

*Warranted, see page 94a.
◆ See "N" suffix note on page 94a.

Chicago Pneumatic Compressors

Ruggedly constructed in solid cast iron powdercoated tanks equipped with stop/start pressure control, safety valves, thermally protected motor and oil sight glass.

Catalog/Online EXCLUSIVE

P. NEW Chicago Pneumatic® 26-gallon Vertical Single Stage Compressor. Features a 2-hp motor that delivers 130 psi max. pressure. Wt. 165 lbs.
009-82920N ♦ **549.99**

Catalog/Online EXCLUSIVE

Q. NEW Chicago Pneumatic® 60-gallon Vertical Two Stage Compressor. Delivers 25.25 ACFM at 100 psi; 22.28 ACFM at 175 psi. Sturdy construction prolongs life tool. Features 7.5-hp electric motor with integrated after cooler and a magnetic starter. 80-gallon tank has 3/4-inch outlet. Wt. 489 lbs.
009-82921N ♦ **2,199.99**

Catalog/Online EXCLUSIVE

R. NEW Chicago Pneumatic® 20-gallon Horizontal Single Stage Compressor. Features a 2-hp motor that delivers 130 psi max. pressure. Wt. 155 lbs.
009-82919N ♦ **519.99**



ALL NEW

Check online for **SALE PRICING!**

AIR DRIVE TOOLS



Catalog/Online EXCLUSIVE

S. NEW CP® Reversible 1/4-inch Mini Drill and 13-piece Inch Drill Bit Set. Compact and lightweight general purpose, reversible drill delivers 2,700 rpm. Planetary gearing with brass bushings. Jacobs chuck 1/4-inch capacity. Bit sizes include 1/16, 5/64, 3/32, 7/64, 1/8, 9/64, 5/32, 11/64, 3/16, 13/64, 7/32, 15/64 and 1/4 in. Includes chuck key and carrying case. Wt. 1.5 lbs.
009-98319 **149.99**

Also Available

CP® Reversible 1/4-inch Mini Drill and 13-piece Metric Drill Bit Set. Bit sizes include 1.5, 2, 2.5, 3, 3.2, 3.5, 4, 4.5, 4.8, 5, 5.5, 6 and 6.5 mm. Includes chuck key and carrying case. Wt. 1.5 lbs.
009-89550 **149.99**



Catalog/Online EXCLUSIVE

T. NEW CP® Cordless 3/8-inch Drill, Impact Wrench and Light Kit. Impact wrench delivers 95 ft.-lbs. and drill delivers 1,300 rpm. Includes work light, 2 batteries and charger. Wt. 7 lbs.
009-89581 **399.99**

Catalog/Online EXCLUSIVE

U. NEW CP® 12-volt Cordless 1/2-inch Impact Wrench. Compact, yet very powerful, this mighty tool features DuoPac clutch for strong smooth operation and aluminum clutch housing. Delivers maximum 95 ft.-lbs. of torque with 2,400 rpm. Chemical-resistant protective rubber on grip and battery pack. Easy change sliding battery. LED light for dark work areas. Includes impact wrench, two batteries, charger and case. Wt. 15 lbs.
009-82922 **479.99**

Catalog/Online EXCLUSIVE

V. NEW CP® 3/8-inch Impact Wrench. Designed for high-performance and comfortable operation, this wrench features a lightweight composite handle, one-hand forward/reverse button, twin hammer clutch, 3-position power setting and 360-degree swivel exhaust. Delivers 275 ft.-lbs. of torque. Wt. 2.55 lbs.
009-82923 **249.99**



Also Available

NEW CP® Impact Sockets. Premium high-performance sockets combine strength, durability, looks and top quality. Easy-to-read laser-etched tough chrome-moly steel sockets. Each packaged in sturdy case. Limited lifetime warranty!*

009-82924 SAE 3/4-in. 14-piece deep. Wt. 19.6 lbs. **189.99**
009-82925 MET 3/4-in. 8-piece deep. Wt. 12.6 lbs. **119.99**
009-82926 SAE 1-in. 8-piece deep. Wt. 16.9 lbs. **149.99**
009-82928 MET 1-in. 8-piece deep. Wt. 18.5 lbs. **179.99**

W. NEW CP® 3/8-in. 9-pc. SAE Magnetic Deep Impact Set. Model 89401-6457. Wt. 2.5 lbs.
009-15130 **129.99**



MORE CHICAGO PNEUMATIC TOOLS AVAILABLE AT SEARS.COM/SHOPTOOLS



INTRODUCING THE PRO-GUN MEGA MASTER SET



1/2-INCH

A

MORE TO EXPLORE
 >> at sears.com!



B



C



D

Catalog/Online EXCLUSIVE
A. SK® 91-piece 1/2-in. Drive Pro-Gun Impact Wrench and Tested Tough Corrosion-Resistant Impact Socket Master Set. The most comprehensive 1/2-in. drive impact socket and Pro-Gun set that SK has ever assembled. Featuring fractional and metric impact sockets (in standard, deep and swivel profiles), extensions and a powerful 1/2-in. drive Pro-Gun impact wrench with twin-hammer design. All sockets and extensions are packaged in either molded storage cases or trays for convenient storage in your toolbox. Contains 14 inch sockets – 3/8 thru 1 1/4-in.; 16 metric sockets – 8 thru 22 and 24 mm; 14 inch deep sockets – 3/8 thru 1 1/4-in.; 14 metric sockets – 10 thru 22 and 24 mm; 12 inch swivel sockets – 1/2 thru 1 1/4-in.; 15 metric swivel sockets – 10 thru 24 mm; 2, 3, 5 and 10-inch extensions and 1/2-in. drive Pro-Gun pneumatic impact wrench. Wt. 40 lbs.
009-15135 1,099.99

Catalog/Online EXCLUSIVE
B. SK® 57 Piece 1/2-in. Drive Impact Socket Master Set. SK's most complete 1/2-in. drive impact socket set with standard, deep, universal joint and swivel impact sockets. All sockets and extensions are packaged in molded storage cases for convenient storage in your toolbox. Contains 7 inch sockets – 3/8 thru 3/4-in.; 12 metric sockets – 8 thru 19 mm; 7 inch deep sockets – 3/8 thru 3/4-in.; 10 metric deep sockets – 10 thru 19 mm; 8 inch swivel sockets – 3/8 thru 3/4-in.; 10 metric swivel sockets – 10 thru 19 mm; 3 and 5-in. extensions and universal joint. Wt. 15.3 lbs.
009-15137 539.99

Catalog/Online EXCLUSIVE
C. SK® 61-piece 3/8-in. Drive Impact Socket Master Set. SK's most complete 3/8-in. drive impact socket set including standard, deep and swivel impact sockets. All sockets and extensions are packaged in either molded storage cases or trays for convenient storage in your toolbox. Contains 8 inch sockets – 5/16 thru 3/4-in.; 12 metric sockets – 8 thru 19 mm; 8 inch deep sockets – 5/16 thru 3/4-in.; 12 metric deep sockets – 8 thru 19 mm; 8 inch swivel sockets – 5/16 thru 3/4-in.; 10 metric swivel sockets – 10 thru 19 mm; 3, 6 and 10-in. extensions. Wt. 15.35 lbs.
009-15139 434.99

Catalog/Online EXCLUSIVE
D. SK® 17-piece 1/4, 3/8 and 1/2-in. Drive Impact Accessory Master Set. Add to your SK impact socket assortment with this accessory master set featuring extensions, universal joints and adapters. Contains 1/4, 3/8 and 1/2-in. drive universal joints, 3/8-in. Female to 1/2-in. Male; 1/2-in. F to 3/8-in. M; 1/2-in. F to 3/4-in. M; 3/4-in. F to 1/2-in. M adapters; 2, 3 and 6-in. 1/4-in. drive extensions; 3, 6 and 10-in. 3/8-in. drive extensions; 2, 3, 5 and 10-in. 1/2-in. drive extensions. Wt. 5.8 lbs.
009-15138 159.99

3/8-INCH

E | NEW

Catalog/Online EXCLUSIVE
E. NEW SK® 28-piece 6-point Standard and Deep Inch Impact Socket Set with 4-piece Extension Set. Featuring SK's patented SureGrip hex design, which drives the side of the hex, not the corner. Design provides for improved access to hard-to-reach fasteners. Improved coating for better rust resistance. Sizes include standard 3/8, 7/16, 1/2, 9/16, 5/8, 11/16, 3/4, 13/16, 7/8, 15/16, 1, 1 1/16, 1 1/8, 1 1/4 in.; deep 3/8, 7/16, 1/2, 9/16, 5/8, 11/16, 3/4, 13/16, 7/8, 15/16, 1, 1 1/16, 1 1/8, 1 1/4 in. Comes with 2, 3, 5 and 10-inch extensions. Wt. 18.2 lbs.
009-79565 259.99

includes
4 piece extension set
 4 sizes for improved access

Also Available
Catalog/Online EXCLUSIVE
SK® 30-piece 6-point Standard and Deep Metric Impact Socket Set with 4-piece Extension Set. Sizes include standard 8 thru 22, 24 mm.; deep 10 thru 22, 24 mm. Comes with 2, 3, 5 and 10-inch extensions. Wt. 15 lbs.
009-79566 259.99

*Warranted, see page 94a.



AIR DRIVE TOOLS

Catalog/Online EXCLUSIVES
PRO-GUN IMPACT WRENCHES

F. SK® 3/4-inch Pro-Gun Impact Wrench with 33 mm Budd Wheel Socket. Wt. 11.05 lbs.
009-19332 549.99

G. SK® 3/4-inch Pro-Gun with 6-inch Extended Anvil with Dual Drive 1 1/2-inch Hex x 13/16 in. Square Budd Wheel Socket. Wt. 22.5 lbs.
009-15140 629.99

H. SK® 1-inch Pro-Gun Impact Wrench with 1 1/2-inch Budd Wheel Socket. Wt. 20.25 lbs.
009-19333 784.99

J. SK® 1-inch Pro-Gun with Standard Anvil with 6-Point Deep 33 mm Budd Wheel Socket. Wt. 5.69 lbs.
009-15141 719.99

K. SK® 3/8-inch Pro-Gun Impact Wrench with Impact Socket Set. Wt. 11.3 lbs.
009-19330 389.99

L. NEW SK® Pro-Gun 1/2-inch Impact Wrench Combo Kit with Bag and Cap. Pro-Gun ratchet provides superior comfort and performance with a compact, balanced profile, ergonomic handle and twin-hammer mechanism. Delivers 700 ft.-lbs. maximum torque. Comes with SK zipper bag, wrench boot and cap. Wt. 7.8 lbs.
009-79563 249.99

Also Available
SK® Pro-Gun 3/8-inch Impact Wrench Combo Kit. Wt. 6.1 lbs.
009-79562 239.99

PRO-GUN AIR RATCHETS

M. SK® 1/4-inch Pro-Gun Impact Ratchet. Wt. 5.66 lbs.
009-19334 319.99

N. SK® 3/8-inch Pro-Gun Impact Ratchet. Wt. 6.02 lbs.
009-19335 259.99

P. NEW SK® Pro-Gun 3/8-inch Mini Wobble Air Ratchet with Bag and Cap. Wt. 3.95 lbs.
009-79564 154.99

PRO-GUN AIR HAMMERS

Q. SK® Short Barrel Pro-Gun Air Hammer with Quick-Release Chuck. Wt. 4.6 lbs.
009-19336 119.99

R. SK® Long Barrel Pro-Gun Air Hammer with Quick-Release Chuck. Wt. 6.2 lbs.
009-19337 139.99

Also Available
Craftsman 4-piece Air Chisel Set. Wt. 4.9 lbs.
009-18687 25.99

F-J includes Budd Wheel Socket

SK® Pro-Gun Impact Wrenches and Air Hammers Feature Magnesium Composite Housings for Lightweight Durability

Powerful twin-hammer motors provide high-torque acceleration in the critical first five seconds of use, while textured rubber handles enable a comfortable and firm grip for extended use. The Pro-Gun series also includes 1/4 in. and 3/8 in. professional air ratchets. The 1/4 in. ratchet is a small and lightweight single-piece housing design with textured rubber grip allowing access into tight places. The 3/8 in. ratchet features a patented anti-head spread design which increases durability. The SK Pro-Gun family – high quality, powerful, lightweight and comfortable.

SEE THE COMPLETE SK TOOL LINEUP AND ALL THE DETAILS AT SEARS.COM/SHOPTOOLS



P NEW

L NEW

HOSE REEL ORGANIZERS



A NEW

Catalog/Online EXCLUSIVE

A. NEW Reelcraft® Power Cord Reel. Designed for industrial or home shop settings, this heavy-duty cord reel can be fixed to bench, wall or ceiling. Features 45-foot #12/3 SJEOW cord rated 115v/15A, spring action retraction with latch, adjustable cord stop and corrosion-resistant powdercoat finish. Indoor use only. Wt. 29 lbs. **034-90264** **349.99**



Wind Things Up With Reelcraft



swing arm bracket accessory works with units A-C and G

Check online for **SALE PRICING!**

Catalog/Online EXCLUSIVE

F. Reelcraft® Hose Reel and Cart. Great for grounds maintenance, golf courses, sports turf/athletic fields, pressure wash, farms, ranches, nurseries and orchards. Holds up to 200 ft. of 1/2 in. hose. Garden hose fitting and 10 ft. connecting hose included. Model# 600966-4. Warranted*. Wt. 17.75 lbs. **009-18659** **299.99**



Reelcraft® Heavy-Duty Air Hose Reels

Description	Catalog Number	Weight lbs.	Price
Catalog/Online EXCLUSIVE			
B. 3/8 in. x 25 ft. Hose	009-18999	20	\$189.99
C. 3/8 in. x 50 ft. Hose	009-18644	40	259.99
D. 1/2 in. x 50 ft. Hose	009-18642	57	349.99
1/2 in. x 100 ft. Hose (not shown)	009-16398	97	549.99
3/4 in. x 50 ft. Hose (not shown)	009-16399	88	519.99
E. Swing Bracket for A-C and G.	009-18651	6	69.99
Lets reel swing to direction of pull.			

Catalog/Online EXCLUSIVE

G. Reelcraft® Air/Water Hose Reels. A new, lighter spring-driven hose reel designed for applications that are less demanding, yet require a product that can withstand industrial use. Seven-position guide allows for wall, ceiling or bench mounting. Catch mechanism keeps hose at desired working length. Up to 300 psi. Warranted*. Shop from chart at right.

Reelcraft® Hose Reels

Description	Catalog Number	Model	Weight lbs.	Price
1/4 in. x 35 ft. Hose	009-18655	RT435-OLP	22	\$149.99
1/4 in. x 50 ft. Hose	009-19269	RT450-OLP	25	159.99
3/8 in. x 35 ft. Hose	009-19270	RT635-OLP	23	169.99
3/8 in. x 50 ft. Hose	009-19271	RT650-OLPSPM*	29	199.99
1/2 in. x 35 ft. Hose.	009-18656	RT835-OLP	30	249.99

*Features side-mounting bracket.



H. Craftsman 3/8-inch x 50-foot Air Hose Reel. Designed for portability, this hose reel features a manual hose-layering guide to help eliminate tangles. Features sturdy steel construction with powdercoat paint, carrying handle, mounting bracket, support legs and swivel. Includes 3/8-inch x 5-foot PVC lead-in hose. Wt. 21 lbs. **009-16347** **59.99**



Catalog/Online EXCLUSIVE
J. Craftsman 3/8 x 100-foot Portable Air Hose with Manual Layering Guide. Designed for portability, this reel features a hose layering guide that spools hose without tangling. Includes support legs, drum lock, carrying handle and mounting bracket. Wt. 33 lbs. **009-16346** **89.99**



K. Craftsman Hose Reel. Retractable air hose reel comes with 30-foot 300 psi hose. Features swivel wall mounting for 180-degree use. Made from high impact polypropylene. Wt. 13.1 lbs. **009-16349** **79.99**



L. Craftsman Retractable Air Hose Reels. Features Levelwind technology system that automatically layers the hose evenly across the reel to ensure smooth and easy operating. Shop from chart below.

Craftsman® Retractable Air Hose Reels

Description	Catalog Number	Weight lbs.	Price
3/8 in. x 50 ft. Hose	009-16340	22.25	\$149.99
3/8 in. x 75 ft. Hose	009-16341	27.8	169.99
3/8 in. x 100 ft. Hose	009-18083	31.54	179.99
1/2 in. x 50 ft. Hose.	009-16342	26.4	164.99

16340/16341/18083 includes 1/4-in. MNPT source and discharge hose. 16342 includes 1/2-in. MNPT source and discharge hose.



M

M. Craftsman High Volume Low Pressure Spray Gun.

Operates with minimal overspray. Tip openings and needles have been enlarged. Spray cap has more and larger holes to create a high-volume, low-pressure spray. One-quart capacity. Requires 7.0 SCFM at 40 psi. Warranted. Wt. 4 lbs.

009-15519109.99



N

N. Craftsman 11-piece Air Compressor Accessory Kit with Storage Pouch.

Includes blow gun, safety nozzle, extension tube, rubber tip nozzle, quick-connect coupler, 2 quick-connect studs, inflation needle, tapered nozzle, tire inflator and blow gun adapter. Wt. 1 lb.

009-1639119.99



P. Craftsman 2 1/2-gal. Heavy-Duty Paint Tank. 25-50 psi working pressure. 80 psi maximum pressure. Galvanized steel tank and lid are corrosion-resistant. Easy-to-read pressure gauge and regulator. Wt. 25 lbs.

009-16102109.99



R. Craftsman Air Compressor Accessory Starter Kit. Features 15-foot x 1/4-inch air hose, blow gun, 1/4-inch NPT female quick-connect coupler and 2 studs with 1/4-inch NPT male threads. Wt. 2.1 lbs.

009-1639229.99



S. Craftsman 16-piece Pro Accessory Kit. 16 heavy-duty components designed to optimize air tool operation. Coil hose, quick connect fittings, swivel connector, 1/4-inch shut-off valve, plumbing components, and tape included. Wt. 2 lbs.

009-1619932.99



Q. SAVE \$100 Craftsman 1/2 inch Drive 57-piece Impact Tool Kit.

Includes a 1/2 inch impact wrench, 1/2 inch impact ratchet, 54 EZ-read 1/2 inch laser-etched inch/metric impact sockets. Impact wrench has built-in forward and reverse and patented silencing technology. Max. torque: 400 ft.-lbs. Drive ratchet has 14 1/2 in. tool length for extra leverage, max. torque of 70 ft.-lbs. and no load speed of 150 rpm. Both tools use 1/4 in. air inlet. Set contains 12 6-point inch sockets (3/8 thru 1 1/16 in.), 12 6-point inch deep socket (3/8 thru 1 1/16 in.), two extension bars (3, 6 in.) and 3/8 inch impact adapter. Metric sizes include 12 6-point metric sockets (12 thru 19, 21, 22, 24 and 27 mm), 12 6-point metric deep sockets (12 thru 19, 21, 22, 24 and 27 mm), two extension bars (3, 6 in.), universal joint. Includes XL mechanic's gloves. Separate prices total \$489.95. Wt. 36 lbs.

009-18799389.95



T. Craftsman 10-piece Air Tool Set with Case.

Kit includes 3/8-inch ratchet wrench, 1/2-inch impact wrench, air hammer, 3/8-inch 25-foot air hose and accessories. Ratchet wrench delivers 160 rpm with 45 ft.-lbs. of torque with a compact 1 1/8 in. ratchet head and front end exhaust. Impact wrench delivers 550 ipm, 7,500 rpm and 300 ft.-lbs. of torque with built-in power regulator and pin-type clutch. Air hammer features alloy-treated barrel and heat-treated piston for fluid motion and longer life. Warranted*. Wt. 16.3 lbs.

009-1685299.99

GUARDAIR CORPORATION Air Tools

GUARDAIR® produces the finest line of air tools available on the market today, incorporating the latest pneumatic technology, superior noise control, ergonomic design and safety features which meet or exceed every applicable OSHA requirement.

U

12-inch extension

ALL NEW



Catalog/Online EXCLUSIVE

U. NEW Guardair® Ultra® High Power Safety Air Gun.

Lightweight aluminum handle with premium cushioned grip, adjustable hanging hook and 3/8-inch FNPT inlet. Delivers 2.8 lbs. of thrust at 49 SCFM. Wt. 1.3 lbs.

009-8922639.99

Catalog/Online EXCLUSIVE

V. NEW Guardair® Jet Guard Safety Air Gun.

Air Shield feature forms a protective cone of air to prevent debris from flying back. Precision volume control. Delivers 0.4 lb. of thrust at 35 SCFM. 1/4-inch FNPT inlet. Wt. 0.7 lb.

009-8922719.99



Catalog/Online EXCLUSIVE

W. NEW Guardair® Lazer® Pistol Grip Safety Air Gun.

Pistol grip design for comfort. Venturi nozzle and convenient hanging eyelet. Delivers 0.6 lb. of thrust at 10 SCFM. 1/4-inch FNPT inlet. Wt. 0.55 lb.

009-8923812.99



Catalog/Online EXCLUSIVE

X. NEW Guardair® Lazer® Palm Switch™ Safety Air Gun.

Unique design for superior ergonomics. Venturi nozzle, over-molded trigger and built-in hanging hook. Delivers 0.6 lb. of thrust at 10 SCFM. 1/4-inch FNPT inlet. Wt. 0.5 lb.

009-8922812.99



Catalog/Online EXCLUSIVE

Y. NEW Guardair® Gun Vac.

This powerful portable pneumatic vacuum features a high filtration collection bag and 1/4-inch FNPT inlet. Includes 2 attachments. Wt. 1.6 lbs.

009-8923989.99



Y

AIR GUNS
Made in USA

MORE GUARDAIR AIR TOOLS AT SEARS.COM/SHOPTOOLS

AIR DRIVE ACCESSORIES

*Warranted, see page 94a.

Coxreels® Signature Features On All Models

- Heavy-duty steel construction
- CPC™ Powder Coating
- Rolled edges and ribbed discs for strength and safety
- 2-year limited Warranty.



Catalog/Online EXCLUSIVE

A. Coxreels® EZ-Coil 350 3/8-inch x 50-foot 300 PSI Air Hose Reel. Compact space-saving size and heavy-duty construction make this reel highly versatile and virtually indestructible. Wt. 43 lbs.

009-15094 349.99

Also Available

Coxreels® EZ-Coil 325 3/8-inch x 25-foot 300 PSI Air Hose Reel.

Wt. 28 lbs.
009-15095 299.99

Catalog/Online EXCLUSIVE

B. Coxreels® EZ-Coil MP 450 1/2-inch x 50-foot 2,500 PSI Air Hose Reel. Larger chassis and frame holds longer lengths of hose. Warranted*. Made in the USA. Wt. 54 lbs.

009-15096 479.99

Catalog/Online EXCLUSIVE

C. Coxreels® 112-3-100 3/8-inch x 100-foot Capacity 4,000 PSI Working Pressure Hose Reel.

Wt. 19 lbs.
009-15098 149.99

Catalog/Online EXCLUSIVE

D. NEW 3/8-Inch x 20-foot 300 PSI Air/Water & Tubing Hose Reel. This "Little Giant" is lightweight, compact and mounts to any horizontal or vertical flat surface. Crafted in heavy gauge steel, this unit features an integrated drum-style spring motor with a lower pull tension to avoid stretching of the tubing. This versatile reel is also equipped with a durable composite hub and grommet designed to avoid hose pinching. Wt. 11 lbs.

009-82910 159.99

E. NEW 4-Inch x 24-foot Exhaust Hose Reel. Designed to keep your facility free of toxic fumes and maintain safer air quality. This sturdy reel is built for heavy-duty use with a rugged all-welded steel 'A' frame featuring spun discs, a maintenance-free bearing system, easily accessible main drum with internal ducting, hose guide and a cast iron lock ring with non-sparking bronze pawl. This ideal unit carries an enclosed cartridge-style spring motor and can be mounted on floors, ceilings, and walls. Wt. 103 lbs.

009-82908 999.99

Also Available

Coxreels® 319-620 6-inch x 20-foot Exhaust Hose Reel. Wt. 105 lbs.
009-82909 1,099.99

COLOR CONNEX® — THE COLOR CODE SYSTEM FOR STANDARD INTERCHANGES



Color Connex Air Line Connectors Catalog/Online EXCLUSIVE

Item	Catalog Number	Model Number	Description	Kit	Type	Weight, lbs.	Price
F.	009-15115	A72451C-BG-CRA	3-piece Automotive Color Connex kit of air line connectors	Contains one 1/4-in. FNPT coupler and two each 1/4-in. MNPT plugs.	C-Auto	0.25	\$6.99
G.	009-15116	A76672G-BG-CRA	3-piece Automotive Color Connex kit of air line connectors	Contains one each: 3/8-in. body FNPT coupler and 3/8-in. MNPT plug.	G-Auto	0.35	12.99
H.	009-15117	A76679G-BG-CRA	6-piece Automotive Color Connex kit of air line connectors	Contains two each: 3/8-in. FNPT couplers, 3/8-in. MNPT plugs and 3/8-in. FNPT plugs.	G-Auto	0.65	17.99
J.	009-15119	A73451D-BG-CRA	3-piece Industrial Color Connex kit of air line connectors	Contains one 1/4-in. FNPT coupler and two each 1/4-in. MNPT plugs.	D-Industrial	0.25	5.99
K.	009-15118	HFZKIT11-CRA	Flexzilla® air hose and Color Connex accessory kit. Flexzilla® air hose has extreme flexibility at temp range of -40°F to +150°F. 300 max. psi working pressure	Contains one 1/2-in. x 50-ft. air hose, two each 3/8-in. FNPT couplers, 3/8-in. FNPT plugs and 3/8-in. FNPT plugs.	G-Auto	5.10	69.99
L.	009-15120	AC8050-CRA	23-piece Blow Gun and Accessory Kit	Contains five each 1/4-in. MNPT plugs; two each 1/4-in. industrial FNPT plugs, 1/4-in. MNPT nipples, inflator needles; one each 1/4-in. industrial FNPT quick coupler, 1/4-in. industrial MNPT quick coupler, 1/4-in. FNPT coupler, blow gun body, rubber tip extension, tire inflator extension, extension adapter, ball tire chuck, nozzle, key ring, pencil tire gauge, pocket air gun.	D-Industrial	2.60	49.99

color-coded dedicated lines help ensure that a lubricated (wet) line is not used for a dry line application



- lightweight
- easy to handle
- kink-resistant
- flexible from -40°F to +150°F



Flexzilla™ The Monster Air Hose Catalog/Online EXCLUSIVE

Item	Catalog Number	Model Number	Description	Weight, lbs.	Price
M.	009-18665	HFZ14100YW2-CRA	Flexzilla™ 1/4 in. x 100 ft. Hi-Vis Air Hose	7.13	\$49.99
Also Available					
	009-18670	HFZ3850YW2-CRA	Flexzilla™ 3/8 in. x 50 ft. Hi-Vis Air Hose	4.81	39.99
	009-18671	HFZ3825YW2-CRA	Flexzilla™ 3/8 in. x 25 ft. Hi-Vis Air Hose	2.63	24.99
	009-18666	HFZ1450YW2-CRA	Flexzilla™ 1/4 in. x 50 ft. Hi-Vis Air Hose	3.75	29.99
	009-18667	HFZ12100YW3-CRA	Flexzilla™ 1/2 in. x 100 ft. Hi-Vis Air Hose	12.63	99.99
	009-18668	HFZ1250YW3-CRA	Flexzilla™ 1/2 in. x 50 ft. Hi-Vis Air Hose	5.94	59.99
	009-18669	HFZ1225YW3-CRA	Flexzilla™ 1/2 in. x 25 ft. Hi-Vis Air Hose	3.50	39.99



P NEW

BUY ONLINE
PICK-UP IN STORE!
on eligible items

N NEW

Catalog/Online EXCLUSIVE

N. NEW LincolN® Used Oil Receiver. A quick, safe and affordable tool for draining, transferring and evacuating used oil. Crafted in durable steel, unit features 18-gallon tank, 14-inch telescoping bowl, reinforced dispensing tube that doubles as sight gauge and safety valve. Use shop air up to 150 psi. Model #3601. Wt. 66 lbs.

009-82912 199.99

P. NEW LincolN® Heavy-Duty Lube Accessory Kit.

A complete selection of adapters and extensions that work with all standard grease guns and dispensing devices. Quick-connect couplings make changing adapters fast and easy. Includes press-on 90-degree for "inaccessible" grease fittings; straight extension for recessed fittings; 12-inch hose extension; rubber-tipped nozzle; needle nozzle for contact flush-type or hard-to-reach hydraulic-type fittings; 360-degree coupler; 2-inch steel extension tube and locking sleeve. Model #58000. Wt. 3.5 lbs.

009-82911 99.99



LINCOLN

Catalog/Online EXCLUSIVE

Q. LincolN 14.4-volt Power-Luber™.

Heavy-duty 14.4-volt cordless grease gun gives you the power to lubricate just about anything, anytime, anywhere. Two-speed switch offers high-pressure or high-volume delivery. Features cycle indicator pin to monitor grease output, charging system for reliable power, built-in hose and coupler holder. Includes grease gun, charger, battery and case. Model #1442. Wt. 13.4 lbs.

009-16217 249.99

Also Available

LincolN Power-Luber™ 14.4-volt Battery.

Model #1401. Wt. 1.7 lbs.

009-16218 89.99

Catalog/Online EXCLUSIVE

R. LincolN Automatic Air-Operated Grease Gun.

Just squeeze the variable-speed trigger for continuous cycle lubrication. Self-priming unit features a 30-in. flex hose. 6,000 max. psi pressure and a durable motor with a 40:1 output ratio. Model #1162. Wt. 5.4 lbs.

009-15122 99.99

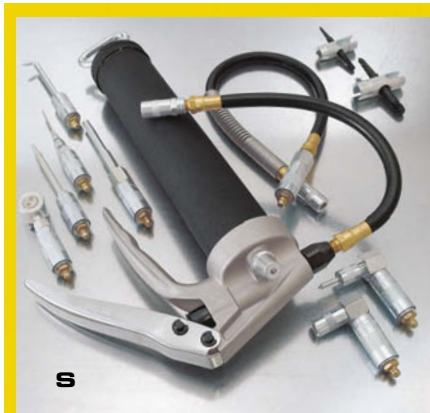

S



U

Catalog/Online EXCLUSIVE

S. Legacy Mega Grease Combo. Includes variable stroke pistol grip grease gun with 12-inch flexible extension and positive grip handle. The heavy-duty Lube Link Contractor Kit contains 18-inch flexible hose, injector needle and eight useful couplers. Warranted*. Wt. 7.64 lbs.

009-18154 179.99

Catalog/Online EXCLUSIVE

T. Legacy Porta-Heat™ Grease Heater Combo.

Keep grease flowing under cold conditions. Includes variable stroke pistol grip gun with 12-inch flexible extension and ergonomic, positive grip handle. Grease heater maintains working temperature so grease is always ready to go. Grease box protects up to 12 tubes from water, dust and weather. Wt. 7.2 lbs.

009-18150 99.99

Catalog/Online EXCLUSIVE

U. Legacy MegaPower™ 12-volt Grease Gun Combo.

12-volt battery-operated gun features Dual Feed Capability™. Connect to either 5-gallon pails or cartridges. Delivers up to 8,000 psi. With planetary gear drive, plated steel barrel and machined/hardened piston. With charger, two batteries and case. Wt. 10 lbs.

009-18677 99.99



T



V NEW

CRAFTSMAN

W

IR Ingersoll Rand

speed-adjust holster

Y NEW

CRAFTSMAN
PROFESSIONAL

X

5-ft. hose

Z NEW

Catalog/Online EXCLUSIVE

V. NEW Ingersoll Rand Air-Operated Grease Gun.

Designed for dependability and convenience. Features a comfort grip plunger and 360-degree swivel handle. Offers three-way grease loading, 6,000 max. psi pressure, and a durable motor with a 40:1 output ratio. Model 5180G. Wt. 7.5 lbs.

009-15121 49.99

W. Craftsman Single Shot Lube Gun.

Features a heavy-duty spring and exclusive piston design that allows self-priming. Loads any of three different ways: 14 oz. cartridge, bulk-filled or canister-filled. Balanced head design, 40:1 output ratio (2,400 to 6,000 lbs. of output pressure). 1.0 SCFM at 90 psi. Warranted*. Wt. 3.4 lbs.

009-19958 29.99

X. Craftsman Professional Continuous Flow Grease Gun.

Ideal for maintaining cars, boats, mowers and more. Cushioned grip and button-style trigger stops grease flow on release. Self-priming for steady performance, even between cartridges. Features heavy-duty spring and piston design. Fully automatic. Uses 14-ounce cartridges. Warranted*. Wt. 3.48 lbs.

009-19959 49.99

Catalog/Online EXCLUSIVE

Y. NEW Posi-Lock® One-Hand Grease Gun Applicator.

Free up your trigger hand for mobility and safety. Installs on electric DC battery operated grease guns. Includes micro switch at grease coupler, 5-foot, 10,000 psi hose, speed adjust holster and hose adapters for several brands of grease guns. Wt. 1.5 lbs.

009-82866 49.99

Z. NEW PBT® Fluid Transfer Pump.

Convert your 3/8-inch ratchet into a fluid transfer pump. Features "first use" self-priming design, retaining bracket for one-hand operation and quick couple fittings. Wt. 2.1 lbs.

009-82907 79.99

AIR DRIVE ACCESSORIES

*Warranted, see page 94a.



TOOL ORGANIZER



TRAY



PEG HOLE ADAPTER

All components shown attached to standard roll-away storage unit.

Craftsman air tool storage solution

A must for any shop or garage in which air tools are in frequent demand. These handy storage adapters keep tools on-hand, yet conveniently stowed. Air hose and tools sold separately.

ALL NEW

Craftsman Air Hose Reel.
Sold separately at sears.com/toolgifts
009-16349 **79.99**



D NEW

Catalog/Online EXCLUSIVE

A. NEW Craftsman Air Tool Organizer. Mount on wall, bench or shelf to free up drawer space. Simply attach air tool using the universal coupler to hold tools in a convenient upright position. Comes with two organizers, four universal couplers and mounting hardware. Measures 11 x 3 1/2 x 3/4 in. Wt. 3.5 lbs.
009-79540 **39.99**

Catalog/Online EXCLUSIVE

B. NEW Craftsman Side Tray for Pegboard Air Hose Reel Adapter. Add a 15 1/2 x 11 1/2 x 1 in. work storage surface to your pegboard adapter with this all-steel tray. Holds up to 90 lbs. Features adjustable height and rubber work mat. Wt. 5.2 lbs.
009-79539 **39.99**

Catalog/Online EXCLUSIVE

C. NEW Craftsman Pegboard Air Hose Reel Adapter for Roll-Away Units. An innovative way to stow your air hose, the reel adapter is an all-steel pegboard with a 90-lb. capacity. Allows mounting of standard peg hooks for additional tool storage. Measures 23 1/4 x 15 1/2 x 1 in. Wt. 10.5 lbs.
009-79538 **59.99**

D. NEW Craftsman Portable Automotive Service Tray. Designed for portability and convenience, this rolling service tray features six parts dividers, slots for long tools, non-slip inserts and non-slip caster wheels (two locking). Holds up to 75 pounds. Adjustable 34 to 47 1/2-inch height reduces repetitive bending. Wt. 25 lbs.
009-87767 **99.99**



E



F

ALL NEW

SEARS.COM/SHOPTOOLS
Sign up to be notified when items go on sale.

Catalog/Online EXCLUSIVE

E. NEW H. Wilson® Rolling Work Surface and Storage Cart. Take your work surface with you. This handy cart features a roomy storage drawer with key lock. Four 4-inch swivel wheels support 125 lbs. each. Unit measures 42 inches high. Wt. 49 lbs.
009-87697 Red **229.99**
009-87700 Black **229.99**

Catalog/Online EXCLUSIVE

F. NEW H. Wilson® Mobile Mechanics Seat with Storage. Unit measures 26.5 inches high. Wt. 38 lbs.
009-87695 Red **149.99**
009-87696 Black **149.99**

Catalog/Online EXCLUSIVE

G. NEW Craftsman Fender and Seat Protectors. Heavy-duty reusable cover protects vehicle from scratches and spills during repair. Elasticized hem allows a perfect fit on most full size cars, trucks and SUVs. Features radiator panel for cooling, wheel access and headlight cover. Dual lining reduces slippage.

Craftsman Large Fender Protector. Best fit on vehicles more than 85 inches wide. Machine washable. Wt. 4 lbs.
009-82876 **149.99**

Also Available

Craftsman Small Fender Protector. Ideal for compact cars under 85 inches wide. Wt. 4 lbs.
009-82877 **139.99**

H. Craftsman Car Seat Protector. Durable reusable cover protects seat from grease, oil, dirt and scuffing during repairs. Fits all seats. Machine washable. Wt. 1 lb.
009-82878 **24.99**



G NEW



H

GOBOXES

GOBOXES has taken some of the world's most recognizable logos, and has turned an ordinary toolbox into a piece of art. These officially licensed products are a perfect way for car enthusiasts to display his/her brand loyalty.

Catalog/Online EXCLUSIVES

J. NEW Chevy Bowtie 11-Drawer Top Chest.

This unique Chevrolet Bowtie-shaped tool box mounts to a variety of lower roller carts. Each of the 18" deep, full-extension drawers have ball bearing slides and hold up to 100 lbs. One lock secures all of the drawers. Foam liners provided. This 120 lb. chest measures 58W x 18D x 21H.

- 009-83242 Blue box with yellow border and white Chevrolet decal599.99
- 009-83244 Black box with red Chevy Racing border decal599.99

Also Available

NEW Chevy Bowtie 11-Drawer Wall-Mount Chest.

Designed to mount to your garage wall allowing full use of your shop floor. A mounting bracket is included with this powdercoated Chevrolet Bowtie-shaped chest. The 9" deep, full-extension drawers have foam drawer liners. This 88 lb. chest measures 58W x 10D x 21H.

- 009-83243 Blue box with yellow border and white Chevrolet decal499.99
- 009-83245 Black box with red Chevy Racing border decal499.99

K. NEW Logo-Style Canvas Bag.

Features an embroidered logo, shoulder strap and handles for easy carrying, these bags are perfect for storing your details supplies or small hand tools.

- 009-83237 Chevy Bowtie—black with red border29.99
- 009-83238 Chevy Bowtie—blue with yellow border with white Chevrolet29.99
- 009-83239 Ford Oval29.99

L. NEW New Chevy Bowtie Metal All-Purpose Box.

Heavy gauge metal features a powdercoated finish. Perfect for storing your detail supplies or small hand tools. Equipped with a comfort grip handle and heavy-duty latches and hinges. The box weighs 9 lbs. and measures 27 1/2 x 7 x 11 1/2 in.

- 009-83230 Blue box with yellow border and white Chevrolet decal59.99
- 009-83231 Black box with red Chevy Racing border decal59.99

M. NEW Ford Oval Portable Metal All-Purpose Box.

A perfect way to show your brand loyalty. Heavy gauge metal with a powdercoated finish for durability. Perfect for storing your detail supplies or small hand tools. Equipped with a comfort grip handle and heavy-duty latches and hinges. The box weighs 9 lbs. and measures 27 1/2 x 7 x 11 1/2H.

- 009-83232 Blue box with white vintage Ford59.99

N. NEW Rich Evans Design Decal on a Metal Powdercoated Finish Portable Box.

Equipped with a comfort grip handle and heavy-duty latches and hinges. Perfect for storing your detail supplies or small hand tools. The box weighs 9 lbs. and measures 27 1/2 x 7 x 11 1/2 in.

- 009-83235 Rich Evans' Huntington Beach Bodyworks logo "Shield"69.99
- 009-83236 Rich Evans' Huntington Beach Bodyworks logos "Shield" with Skulls69.99

AMERICA'S AUTOMOTIVE HERITAGE

ALL NEW



58-INCH

AVAILABLE IN 18 INCH TOP CHEST AND 10 INCH WALL MOUNT DEPTHS

GARAGE SOLUTIONS



Legacy

See more Legacy hoses and connectors on page 134.



P NEW

- lightweight
- easy to handle
- kink-resistant

INCLUDES 10-PC. ACCESSORY KIT



Catalog/Online EXCLUSIVE P. NEW Legacy™ Workforce™ 30-foot Nitrogen Hose Reel. Heavy-duty plastic unit can be mounted on wall or ceiling. Includes 30-foot green 3/8-in. ID nitrogen PVC hose with mounting bracket. Warranted*. Wt. 11.5 lbs.
009-8958879.99

Catalog/Online EXCLUSIVE Q. Legacy™ Flexzilla™ 25-foot Air Hose with Tire Gauge and ColorConnex® Accessories. Incredibly flexible for challenging low temperature environments, this 3/8-in. ID hose comes with air chuck, blowgun and tire gauge. Also includes 7-piece ColorConnex® accessory set. Wt. 3.5 lbs.
009-8958949.99

*Warranted, see page 94a.

RUGGED, RELIABLE AND SECURE! INSTALLATION AVAILABLE*

CRAFTSMAN®

Catalog/Online EXCLUSIVE

A. NEW Craftsman 3/4-hp Chain Drive Garage Door Opener. Powerful 3/4 hp motor for increased speed and power. Two light bulbs for added light and security. Rugged chain drive for smooth, dependable operation. Features Security+® anti-burglary coding, keyless entry and motion-detecting control console. Open/close door from vehicles with built-in visor remote. Wt. 42.25 lbs.

009-53990 **229.99**

Catalog/Online EXCLUSIVE

B. NEW Craftsman 1/2-hp Belt Drive Garage Door Opener. Exceptionally quiet belt drive system. Motion-activated lighting. Two Standard 3-function remotes. Wireless keyless entry pad. Backlit keypad for nighttime use. Security+® anti-burglary coding. Durable steel-reinforced belt lifts even the heaviest garage door. Quiet operation. PosiLock® system securely locks door when it is down. Wt. 38.8 lbs.

009-53915 **229.99**

Catalog/Online EXCLUSIVE

C. NEW Craftsman Belt Drive DC Powered Garage Door Opener with Battery Backup.

DieHard battery back-up powers unit in the event of a power outage. Motion-activated lighting. Includes power unit, two 3-function remotes, control console, wireless keyless entry pad, safety sensors, rail, hardware and operator's manual. Smart control panel shows time, temperature and diagnostics. Security+® anti-burglary coding. Durable steel-reinforced belt lifts even the heaviest garage door. Wt. 38.6 lbs.

009-53918 **279.99**



3 / 4 HP

ALL NEW

1 / 2 HP

BATTERY BACKUP

***LET SEARS PROFESSIONALS DO THE WORK FOR YOU!**
Simply let us know you would like installation when you purchase online or by phone. Need more information? Contact the Sears Blue Service Crew at 1-800-4-MY-HOME, or visit sears.com/homeservices.

WARN® WINCHES

Catalog/Online EXCLUSIVE

D. NEW Warn® Corded PullzAll Winch.

Great for use where power source is available, this rugged, easy-to-use handheld tool lifts or pulls up to 1,000 lbs. Features forward/reverse operation, 15-foot wire rope and swiveling anchor hook. Powerful 110V AC motor moves heavy items into place smoothly and precisely. Wt. 19.2 lbs.

009-83000 **299.99**

Catalog/Online EXCLUSIVE

E. NEW Warn® Cordless PulzAll Winch.

A powerful, lightweight, easy-to-use handheld tool lifts or pulls up to 1,000 lbs. A strong motor and variable speed control allow you to move heavy items into place smoothly and precisely. Features forward/reverse operation, 15-foot wire rope and swiveling anchor hook. Powered by a 24-volt DC battery. Includes rechargeable NiMH battery pack with rapid charger. Wt. 26.4 lbs.

009-83003 **499.99**



variable speed trigger

convenient forward reverse switch

ALL NEW

swiveling anchor hook for hassle-free attachment

15" of durable rope

WARN WORKS



load, lift & store up to 250 lbs.

Includes hand crank and new drill attachment for easy lifting

RACOR PRO HOME STORAGE PRODUCTS

G. RacorPro™ Heavy Lift Ceiling Storage System.

Simply load, lift and store up to 250 lbs. of material on this easy-to-use, safe storage platform. New drill driver attachment allows you to raise and lower the fully-loaded 4 x 4 platform with either your drill or hand crank. (Drill not included.) Frees floor space while keeping your garage clean and tidy. Wt. 60 lbs.

009-59537 **159.99**

Catalog/Online EXCLUSIVE

F. RacorPro™ Ceiling Mount Bike Rack.

Introducing a terrific way to store bikes in unused space with ease and safety. Engineered to lift even heavy bikes effortlessly. Unique rope locking mechanism prevents accidental release. For use on ceilings up to 12 feet high. 50 lbs. weight capacity. Wt. 4.35 lbs.

009-59535 **29.99**



PRESSURE WASHERS

GARAGE SOLUTIONS



POWERED by HONDA

POWERED BY BRIGGS & STRATTON

Sears
Parts & Repair Services

**NEED PARTS OR SERVICE?
CALL 1-800-4-MYHOME OR VISIT
SEARS.COM/HOMESERVICES**

*Warranted, see page 94a.

	H	J	K	L	M	N	P
Brand/Specs	Craftsman	Craftsman	Craftsman	Craftsman	Craftsman	Snapper	Craftsman Pro
PSI (Pounds per Sq. Inch)	2,200	2,550	2,600	3,000	3,000	3,100	3,800
GPM (Gallons Per Min.)	2.2	2.3	2.3	2.7	2.7	2.5	4
Engine	Briggs & Stratton 500 Series™	Briggs & Stratton 675 Series™	Honda GCV 160	Briggs & Stratton Professional Series™ OHV	Honda GCV 190	Briggs & Stratton 900 Series™ OHV	Honda GX390 OHV
Engine Power (ft.-lbs./cc's)	5.00 ft.-lbs., 155cc	6.75 ft.-lbs., 190cc	160cc	8.75 ft.-lbs., 190cc	190cc	9.00 ft.-lbs., 205cc	390cc
Engine Feature		ReadyStart® & Fresh Start® Cap Included		ReadyStart® & Fresh Start® Cap Included		ReadyStart® & Fresh Start® Cap Included	
Pump	Axial Cam	Axial Cam	Axial Cam	Axial Cam	Axial Cam	Axial Cam	Triplex
Spray Tips	3 Quick-Connect Spray Tips (0°, 25°, and Fan Soap)	4 Quick-Connect Spray Tips (0°, 15°, 40° and Fan Soap)	4 Quick-Connect Spray Tips (0°, 15°, 40° and Fan Soap)	5 PrecisionSpray™ Nozzles (General, Max, Jet Soap Jet Flush, Fan Soap)	5 PrecisionSpray™ Nozzles (General, Max, Jet Soap Jet Flush, Fan Soap)	PrecisionSpray™ Selector Wand (Delicate, General, Max, Jet Soap, Jet Flush, Fan Soap)	5 Pro-Style Quick-Connect Spray Tips (0°, 15°, 25°, 40° and Fan Soap)
Soap System	Soap Solution Injection	Perfect Mix™ Direct From Concentrate Soap System	Perfect Mix™ Direct From Concentrate Soap System	Dual Perfect Mix™ Direct From Concentrate Soap System	Dual Perfect Mix™ Direct From Concentrate Soap System	2 Gallon Onboard Detergent Tank	Soap Solution Injection
Hose	1/4" x 25'	1/4" x 25'	1/4" x 25'	1/4" x 30'	1/4" x 30'	5/16" x 30'	3/8" x 50'
Weight	63 lbs.	66 lbs.	65 lbs.	75 lbs.	74 lbs.	77 lbs.	151 lbs.
Catalog Number	071-75218	071-75219	071-75261	071-75221	071-75263	071-75264	071-75238
Price	\$319.99	369.99	379.99	499.99	499.99	624.99	1,249.99



digital readout control panel

Catalog/Online EXCLUSIVE
Craftsman Digital Dual Operation MIG Welder

Solid state electronics, eight voltage setting and a digital interface ensures optimum gas, material and heat control. Unit features a turbo cooling fan, thermal overload protection and full ON/OFF safety control torch, along with an electronic spot timer for precise welding. Welds up to 5/16 inch mild steel, cast iron and stainless steel. Includes 8-foot torch assembly.



WELDERS-PROVEN PERFORMERS

E NEW



5 heat settings

professional grade torch



Maxus® 120-volt MIG/Flux Welder

- 5 heat settings
- professional-grade torch
- 2 extra contact tips
- dual gauges
- wire feed with heavy-duty drive-ck

Catalog/Online EXCLUSIVE

E. NEW Maxus® Pro-420 120-volt MIG/Flux Welder. Built to tackle most welding projects, this heavy-duty unit features 140-amp max. output, professional cold torch with trigger-activated arc, 5 heat settings, wire speed tracking and quick-connect torch. Welds steel from 24 gauge to 3/16 inch. Wt. 90 lbs.

009-82889 399.99

>> Check online for SALE PRICING!

F NEW



4 heat settings

robust steel case



Campbell Hausfeld® Welder

- 4 heat settings
- MIG regulator with hose
- 2 extra tips
- starter spool of flux core wire

Catalog/Online EXCLUSIVE

F. NEW Campbell Hausfeld® 115-volt MIG/Flux Core Wire Feed Welder. Packed with features, this versatile unit handles welds from 24 gauge to 3/16-inch steel. Features duty cycle of 20% at 70 amp, 4 heat settings and infinite wire speed control for smooth, even weld bead. Professional torch with trigger activated arc. Also features thermal overload protection, external polarity control and independent drive deck. Wt. 49 lbs.

009-82888 299.99

Craftsman Welders

Item	Catalog Number	Primary Input	Input Plug	Welding Range	Rated Duty Cycle	Wt., lbs.	Price
A.†	009-30084N◆	220-Volt	50 amp	30-180 amps	20%@160 A	101	\$1,699.99
B.	009-20569	120-Volt	20 amp	30-100 amps	40%@60 A	90	459.99
C.	009-20568	120-Volt	20 amp	30-85 amps	20%@60 A	48	279.99

†Catalog/Online EXCLUSIVE



Gas/No Gas Wire Feed Welder with Cart

- multiple heat settings
- welds up to 3/16 in.-mild steel
- infinite adjust wire speed
- includes MIG gun, mask, wire spool, hammer, brush and cart

Gasless Wire Feed Welder

- welds up to 3/16 in.-thick steel
- welds all types of carbon steel
- multiple settings for accurate power control
- infinite adjust wire speed control
- automatic thermal safety switch



D. Craftsman Fume and Smoke Exhauster.

Exhaust fumes, smoke and heat from welding, brazing and soldering operations. Supplies fresh (unfiltered) air to confined work areas. Features heavy-duty steel frame, steel impeller in fiberglass housing. Includes an intake screen to prevent accidental access. Comes with 9 ft. wire-reinforced PVC inlet hose and clamps, 90° sheet metal exhaust elbow. 1/2-hp, 115/230VAC motor, 6.8/3.4 amps, 5,200 fpm, 600 cfm, 7 inches of H₂O max. static pressure. Imported. Warranted*. Wt. 45 lbs.

009-21394 499.99



WELDING HELMETS

Catalog/Online EXCLUSIVE
G and H. Craftsman Magnetic Sensing Welding Helmets.

Introducing arc sensing welding recognition technology helmets. The revolutionary auto-darkening filter responds to both the visible arc light and the magnetic field created by current flow through the workpiece. Prevents premature switching and flickering. Ideal for all welding processes including TIG and TIG pulsing. Fully adjustable sensing system can be fine-tuned to ambient conditions. Viewing area measures 1.6 x 3.8 in. Variable shades #9 to #13 UV/IR. Warranted*. Wt. 2.2 lbs.

G. Craftsman Black Magnetic Sensing Welding Helmet.
 Mfg. #24400-610.
009-20819 299.99

H. Craftsman Stratto Blue Magnetic Sensing Welding Helmet.
 Mfg. #24141-610.
009-20818 299.99

Catalog/Online EXCLUSIVE
J thru L. Craftsman Autodark Welding Helmets.

Lightweight, balanced and durable professional welding helmets. Solar filter with lithium battery assist darkens automatically to a shade #10. Features 4.5 sq. in. viewing area. Helmet meets ANSI and CUL standards. Warranted*. Wt. 2.5 lbs.

J. Craftsman Finish Line Welding Helmet.
009-20743 99.99

K. Craftsman Freedom Helmet.
009-20744 99.99

L. Craftsman America Helmet.
009-20745 99.99



Catalog/Online EXCLUSIVE
M. SAVE \$30 Craftsman Hell Raiser 3-in-1 Next Generation Auto-Darkening Welding Helmet with Protective Helmet Sleeve. The smartest auto-darkening helmet on the market, this helmet features 3-in-1 "grind/torch/weld" shade settings, Intellisense™ technology to detect welds less than 5 amps, and a sealed SmartView™ LCD soft touch control panel. Features fast switching speed, low battery indicator and auto-off option. Regular price \$299.99. Warranted*. Wt. 5 lbs.
009-20847 269.99

Catalog/Online EXCLUSIVE
Craftsman Freestyle Welding Helmets

Craftsman introduces our latest in auto-darkening welding helmet technology. With 13 sq. in. of viewing area, our new helmet provides the largest viewing area in our lineup. In addition, we've incorporated versatile 3-in-1 technology for welding, grinding and cutting modes. With built-in Intellisense™ technology, it is ideal for low-amp TIG application. Depending on your work setting, there are variable shade, sensitivity and delay adjustments to meet all your needs. Wt. 2 lbs.

N. 009-47534 299.99

Craftsman Freestyle Shade #10 Welding Helmet. Fixed shade #10 helmet meets ANSI 287.1. Wt. 2 lbs.
P. 009-47535 49.99

Craftsman Essential Welding Helmets

Q. 009-20653 2 x 4 1/4 in. Fixed-front Wt. 2.5 lbs. \$19.99	R. 009-20655 2 x 4 1/4 in. Lift-front Wt. 2.5 lbs. 24.99
S. 009-20657 4 1/2 x 5 1/4 in. Fixed-front Wt. 2.5 lbs. 29.99	T. 009-20659 4 1/2 x 5 1/4 in. Lift-front Wt. 2.7 lbs. 34.99



Catalog/Online EXCLUSIVE

U thru X. Hobart Auto-Darkening Welding Helmets. Extremely lightweight (16 oz.) and durable welding helmets by Hobart! All designs have ratcheting headgear with multiple adjustments for maximum comfort. The auto-darkening lens is battery powered/solar assist with multiple arc sensors on each helmet. U and W are variable shade helmets that are great for multiple welding applications. V and X are fixed shade #10 lens. Both are ideal for multiple welding applications and U is great for low amperage TIG welding. Two-year limited warranty.* Meets ANSI Z87.1-2003 and CUL standards.

U. NEW Hobart Prowler "Off Road" Auto Darkening Welding Helmet. Professional auto-darkening helmet has the largest viewing area. Lightweight design with multiple adjustments for maximum comfort. The 1/20000 lens provides a 9-13 variable shade control, fully adjustable sensitivity and delay controls, with grind mode. Features 4 sensors. Ideal for low amp TIG and inverter arc welding. 2 lithium batteries included. Two-year warranty.* Model 770584, meets ANSI Z87.1-2003/DIN/CSA/TUV/CE standards. Wt. 3 lbs.
009-82930 299.99

W. NEW HOBART "HOT HEAD" XVS Auto Darkening Welding Helmet. Our hottest styled variable adjust, auto-darkening welding helmet. Lightweight design with multiple adjustments for maximum comfort. The 1/12000 lens provides a 9-12 variable shade control, adjustable sensitivity and delay controls; Solar-powered/AAA battery-assisted lenses. 100% ultraviolet and infrared protection. Two-year warranty.* Model 770583, meets ANSI Z87.1-2003/CSA/CE standards. Wt. 3 lbs.
009-89224 179.99

V and X. Hobart XFS Auto Darkening Welding Helmets Protect face and eyes with these fixed-shade #10 helmets. Both meet ANSI Z87.1 standards, lenses meet CSA/CE standards. Solar-powered/battery-assisted lenses react in 1/3600 sec. Lithium battery included. Two-year limited warranty. V. Model 770432. Wt. 2 lbs.
009-30082 109.99

X. Hobart Forever Blue™ Auto Darkening Helmet. Features Future Farmers of America logo. Wt. 2 lbs.
009-47536 129.99

*Warranted, see page 94a.
 ♦ See "N" suffix note on page 94a.

LINCOLN ELECTRIC – THE WELDING EXPERTS™

SUPERIOR PERFORMANCE FOR PROFESSIONAL RESULTS



A Power MIG 215XT Welder

- Diamond Core technology for superior arc
- Rugged cast aluminum industrial wire drive
- Seven tapped voltage ranges
- Generous 15 ft. gun and cable assembly

#K2700-1

B Power MIG 255XT Welder

- Diamond Core technology for superior arc
- Rugged cast aluminum industrial wire drive
- Digital meter display
- 115V auxiliary receptacle (power grinder, etc.)

#K2701-1

Handy MIG Welder #K2185-1

- welds mild steel from 24-gauge to 1/8-in.
- fan-cooled for long life
- includes everything you need to get started
- safely keeps wire “cold” until trigger is pressed



D NEW



Easy-MIG 140 Welder #K2697-1

- wide 30–140 amp welding amperage range
- welds 24-gauge to 5/16-in.
- aluminum spool gun ready—add the optional Magnum spool gun to weld aluminum

E NEW

Handy Core Wire Feed Welder #K2278-1

- welds mild steel from 18-gauge to 1/8-in.
- fan-cooled for long life
- includes everything you need to get started
- compact, portable lightweight and easy to use



F NEW



Easy-MIG 180 Welder #K2698-1

- wide 30–180 amp welding amperage range
- welds 24-gauge to 1/2-in.
- aluminum spool gun ready—add the optional Magnum spool gun to weld aluminum

G NEW

Magnum 100SG Spool Gun #K2532-1

- low-cost, reliable precise aluminum welding
- 10 ft. gun cable, control harness and connector
- spool gun is an option to be added to the K2697-1 Easy MIG 140 or the K2698-1 Easy MIG 180



Welding Cart #K2275-1

- full-featured welding cart
- transport welder
- can hold a 80 cubic foot gas cylinder
- store welding cables and accessories

Lincoln® Electric Welders Catalog/Online EXCLUSIVE

Item	Catalog Number	Input Circuit	Input Voltage	Welding Range	Rated Duty Cycle	Wt., lbs.	Price
A.	009-83191N◆	45/41 amp	208/230	30-250	30%@215 A	210	\$1,799.99
B.	009-83193N◆	56/52 amp	208/230	30-300	40%@250 A	220	2,399.99
C.	009-20580	20 amp	115	35-88	20%@70 A	46	299.99
D.	009-47537	20 amp	115	30-140	20%@90 A	58	679.99
E.	009-47538	20 amp	115	35-88	20%@70 A	46	279.99
F.	009-47539	20/20 amp	208/230	30-180	30%@130 A	66	849.99
G.	009-47540	—	—	—	—	10	199.99
H.	009-20848	—	—	—	—	25	89.99
J.	009-20012N◆	50 amp	230	40-225 AC 30-125 DC	20%@225 A 20%@125 A	129	599.99
Also Available							
	009-20015N◆	50 amp	—	40-225 AC	20%@225 A	113	279.99
K.	009-83194N◆	94/85 amp	208/230	5-230 amp	100%@90 A	212	2,199.99
L.	009-83279N◆	20 amp	115	10-20 amp	40%@20 A	21	999.99
M.	009-20610N◆	—	—	50-210 amp DC	100%@210 A	502	2,899.99
N.	009-20130N◆	—	—	70-125 amp AC	60%@100 A	160	1,399.99
P.	009-47542	34/33 amp	115/230	5-155 amp DC	100%@100A	14.7	1,299.99
Also Available							
Undercarriage Wheel Kit. For Welders 20012 (“J”) and 20015.							
Provides convenient mobility. Includes two 6-inch wheels and all hardware. Wt. 3 lbs.							
	009-20014						12.99
Undercarriage Wheel Kit. For Welder/Generator 20610 (“M”).							
Adds mobility. Move by hand with pneumatic tires. Model #K889-2. Wt. 58 lbs.							
	009-20189						199.99



J
AC/DC 225 Welder #K1297
 • welds carbon, low alloy and stainless
 • welds 16-gauge and heavier steel
 • uses electrodes up to 3/16 in.

K NEW



Precision TIG 225 Welder #K2533-1

- Micro Start II technology improves arc starting, welding and cratering
- built-in engine pulse control
- built-in auto balance



L NEW

P20 Plasma #K2820-1

- cuts steel, aluminum, expanded and other metals
- recommended capacity 1/8 in.
- maximum capacity 1/4 in.



Eagle 10,000 Welder/Generator #K2343-2

- features 23 hp Kohler Command 2-cylinder 4-cycle OHV engine
- outputs 9,000 continuous watts
- 20-ft. welding and 15-ft. ground cables



MORE TO EXPLORE
 at sears.com!

Power Arc 5500 Welder/Generator #K1429-8

- features 9 hp Robin/Subaru gas engine
- outputs 4,000 continuous watts
- rugged tube frame roll cage provides multiple carry points



ALL NEW

Q. NEW Harris® PORT-A-TORCH®. When portability is essential. This outfit contains everything needed for cutting, welding and brazing in a rugged ballistic nylon bag with high impact ABS frame. Designed to carry one MC acetylene cylinder and one 20 cu. ft. oxygen cylinder. With non-skid feet, nylon shoulder straps and handy pockets inside and out. Cutting attachment includes solid brass head, tail and stainless tubes. Includes brass torch handle with reverse flow check valves, rugged brass regulators, goggles, one cutting and one welding tip, striker and 12-ft. hose. Model 4403211. Wt. 37 lbs.

009-83045399.99

R. NEW Harris® Cutwelder Kit. With the same high quality torch handle, tips, regulators, goggles, flint striker, wrench and hose as the PORT-A-TORCH, the Cutwelder kit also features a compact ballistic nylon tool bag with non-skid feet. Features 4 outside/2 inside storage pockets. Model 4403212. Wt. 11 lbs.

009-83046299.99

Catalog/Online EXCLUSIVE LINCOLN® ELECTRIC WELDING HELMETS

Lightweight; adjustable headgear; meets ANSI and CSA Standards Protect against harmful UV invisible light and weld spatter.

S. NEW Cool Shield Black. 2x4 AD Shade 10 Helmet Model K2600-1. Wt. 2.5 lbs.
009-8319599.99

T. NEW Intrepid High Graphic. AD Variable Shade 9-13. Helmet Model K2601-1 Wt. 2.5 lbs.
009-83196129.99

U. NEW Carbon Fiber Graphic. AD Variable Shade 9-13. Helmet Model K2601-2. Wt. 2.5 lbs.
009-83197124.99

V. NEW Chip Foose Graphic. AD Variable Shade 9-13. Helmet Model K2601-3. Wt. 2.5 lbs.
009-83198134.99

R



S



T



W. NEW Lincoln® Electric Welder's Backpack.

- Everything you need to get started. Includes
 • Welding Helmet • Gloves • Chipping Hammer
 • Wire Brush • Welding Clamp • Magnet
 • Soapstone and Soapstone Holder
 • Canvas Cover for Welder • Backpack for Storage
 Warranted*. Wt. 10 lbs.

009-8319989.99

P NEW

Invertec V-155-S #K2606-1

- touch-start TIG DC operation allows you strike the arc easily
- auto adaptive arc force minimizes electrode sticking
- two stick modes, SOFT and CRISP, provide the right arc characteristics for different types of electrodes



WELDING

WELDER/ GENERATORS

Applications:
Maintenance, Construction,
Farm/Ranch, Home

Materials:
4,500 Most Steels
10,000 Most Metals



A
Champion
4500
(Model #500491)

- AC stick
- 140 amp AC stick
- 4,500 watt KVA generator



B
Champion 10,000
(Model #500434 – Kohler
#500433 – Robin)

- 230 amp DC stick
- 10,000 watt KVA generator
- DC TIG

Engine-Driven Catalog/Online EXCLUSIVE

Item	Catalog Number	Generator Power	Receptacles CSA	Circuit Breakers/Weld Control	Welding Amp Range	Weld Thickness	Weld Cables	Duty Cycle	Engine/Fuel Capacity	Engine Start	Warranty Engine/Welder	Weight, lbs.	Price
A.	009-20578N◆	4,500 Surge 4,000 Continuous	(2) 120 V, 20 A (2) 240 V, 20 A	Yes, Resettable/ Single Knob	60-140 A AC	1/4 inch	10-ft. Electrode Cable w/Holder 10-ft. Work Cable w/Clamp	30%@140 A, 20 V 60%@110 A, 25 V 100%@90 A, 25 V	10 HP Briggs & Stratton OHV/1-gallon	Recoil	3-Year/ 5/3/1 Industrial Use	190	\$1,249.99
B.	009-20542N◆	10,000 Surge 9,500 Continuous	(4) 120 V, 20 A (1) 120/240 V, 50 A	Yes, Resettable/ Single Knob	50-230 A DC	1/2 inch	20-ft. Electrode Cable w/Holder 15-ft. Work Cable w/Clamp	30%@230 A, DC 60%@210 A, DC	23 HP Kohler or 22 HP Subaru OHV/10-gallon	Electric Start Auto Idle	3-Year/ 5/3/1 Industrial Use	470	2,749.99

Also Available: 009-20427N◆ Same features and price as 009-20542, but with a 22 HP Subaru engine.

PLASMA CUTTERS

Applications:
250ci – Sheet Metal, HVAC, Auto Body,
Farm/Ranch, Plumbing

400 – Maintenance, Light Construction,
Prototyping, Body Shops, HVAC

625 – Auto Body, Prototyping, Fabrication

Materials:
All Conductive Metals



C
Air Force
250ci
(Model #500534)

- piercing
- built-in air compressor



D
Air Force
400
(Model #500474)

- piercing



E
Air Force
625
(Model #500493)

- gouging
- piercing

Plasma Cutters Catalog/Online EXCLUSIVE

Item	Catalog Number	Cutting Thickness**	Air Compressor	Input Voltage	Cables	Pilot Arc	Duty Cycle	Warranty	Weight, lbs.	Price
C.	009-30080	1/8-in. Clean Cut (Steel), 1/4-in. Sever (Steel), 1/16-in. Stainless, 1/16-in. Aluminum, 1/16-in. Galvanized, 1/16-in. Brass, 1/16-in. Copper	Built-in Piston Driven	115 VAC	16.5-ft. Torch, 16.5-ft. Work Cable w/Clamp	No Yes – starter arc	35%@12 A, 110 VDC	5/3/1 Industrial Use	28	\$799.99
D.	009-20487	3/8-in. Clean Cut (Steel), 5/8-in. Sever (Steel), 1/4-in. Stainless, 1/4-in. Aluminum, 1/4-in. Galvanized, 1/8-in. Brass, 1/8-in. Copper	—	115/230 VAC	20-ft. Torch, 20-ft. Work Cable w/Clamp	Yes – to cut grates, chain link, perforated metals	35%@27 A, 90 VDC	5/3/1 Industrial Use	55	1,299.99
E.	009-20660	1/2-in. Clean Cut (Steel), 7/8-in. Sever (Steel), 3/8-in. Stainless, 3/8-in. Aluminum, 3/8-in. Galvanized, 1/4-in. Brass, 3/16-in. Copper	—	208/230 VAC	25-ft. Torch, 25-ft. Work Cable w/Clamp	Yes – to cut grates, chain link, perforated metals	50%@40 A, 140 VDC	5/3/1 Industrial Use	60	1,899.99

**Ratings based on 10 in./min. Can sever max. thickness with new consumables and proper technique.

STICK

Applications:
Maintenance, Construction,
Farm/Ranch, Rental, Home

Materials:
Steel/Stainless Steel, Cast Iron



F
Stickmate
205 AC
(Model #500502)

- AC stick



G
Stickmate
235 AC/
160 DC
(Model #500421)

- AC stick
- DC stick

BUY ONLINE
PICK-UP IN STORE!
on eligible items

Stick (SMAW) Catalog/Online EXCLUSIVE

Item	Catalog Number	Welding Amp Range (AC)	Welding Amp Range (DC)	Input Voltage	Weld Thickness	Duty Cycle	Cable Length	Amperage Adjustments	Range Select	Electrodes	Warranty	Weight, lbs.	Price
F.	009-20737	30-205 A	—	230 VAC	3/8 inch	20%@165 A (AC) 100%@90 A (AC)	15-ft. Electrode Cable w/Holder, 10-ft. Work Cable w/Clamp	1 A increments	Single	1/16 - 5/32-in.	5/3/1 Industrial Use	92	\$269.99
G.	009-20472N◆	30-235 A	30-160 A	230 VAC	1/2-in. in AC 1/4-in. in DC	20%@225 A (AC) 100%@100 A (AC) 20%@150 A (DC) 100%@60 A (DC)	15-ft. Electrode Cable w/Holder, 10-ft. Work Cable w/Clamp	1 A increments	High/Low AC DCEN/DCEP	1/16 - 5/32-in.	5/3/1 Industrial Use	108	449.99

MIG
Applications:
Maintenance, Construction,
Auto Body, Farm/Ranch,
Rental, Home
Materials:
Steel, Stainless Steel,
Aluminum



H
Handler 125 EZ
(Model #500521)
• flux cored



J
Handler 140
(Model #500500)
• MIG
• flux cored



K
Handler 187
(Model #500525)
• MIG
• flux cored



M
Handler 210
(Model #500526)
• MIG
• flux cored



N **NEW**
Ironman 230
(Model #500536)
• MIG
• flux cored



L **NEW**
Spool Gun For Use with Handler 210
(Model #300199)
• easy set-up
• makes feeding aluminum wire easy

MIG (GMAW) Catalog/Online EXCLUSIVE

Item	Catalog Number	Welding Amp Range	Input Voltage	Weld Thickness	Duty Cycle	Gun Cable Length	Trigger-Activated Arc	MIG Ready	Cart/Wheels	Wire Feed Speed Tracking	Warranty	Weight, lbs.	Price
H.	009-46848	30-125 A	115 VAC	18-ga. 3/16 in.	20%@90 A	8 feet	Yes	No	Option	N/A	5/3/1 Industrial Use	55	\$349.99
J.	009-20502	25-140 A	115 VAC	24-ga. 1/4 in.	20%@90 A	10 feet	Yes	Yes	Option	Yes	5/3/1 Industrial Use	59	479.99
K.	009-20817	25-185 A	230 VAC	24-ga. 5/16 in.	30%@130 A	10 feet	Yes	Yes	Option	Yes	5/3/1 Industrial Use	77	649.99
L.	009-82934	—	—	—	60%@150 A	10 feet	—	—	—	—	One-Year	8.5	249.99
M.	009-47548N◆	25-210 A	230 VAC	24-ga. 3/8 in.	30%@150 A	10 feet	Yes	Yes	Option	Yes	5/3/1 Industrial Use	76.5	899.99
N.	009-82935N◆	30-250 A	230 VAC	24-ga. 1/2 in.	60%@175 A	15 feet	Yes	Yes	Built-in	No	5/3/1 Industrial Use	235	1,499.99
	Also Available 009-20575N◆ IRONMAN 210 (Model #500304)	30-210 A	200/230 VAC	22-ga. 3/8 in.	40%@150 A	10 feet	Yes	Yes	Built-in	No	5/3/1 Industrial Use	174	1,199.99



P **NEW**
Catalog/Online EXCLUSIVE
P. Hobart® "Handler 140" with CO₂ Kit. Patent Pending CO₂ gas kit makes portable MIG welding easy, lightweight and economical. Package includes pre-set CO₂ regulator and gas hose, aluminum cylinder with holder and mounting hardware. The Handler 140 is a compact MIG welder designed to run on 120-volt power. Weld 24-gauge steel up to 3/16-inch plate with CO₂ 1/4-inch with flux core wire. Comes ready to weld with wire and the gas kit (cylinder must be filled with 100% CO₂). Model #500542. Wt. 70 lbs.
009-89222 599.99



R
Catalog/Online EXCLUSIVE
R. Hobart Universal Welder Cart. Keeps wire-feed welder's gun, cables and shielding gas portable and in one area. Convenient storage area for other accessories. Accepts shielding gas bottles up to 75 lbs. Imported. Wt. 29 lbs.
009-20548 99.99

TIG/Stick Catalog/Online EXCLUSIVE

Q. 009-20435N◆... \$1,599.99

	TIG	Stick
Rated Output at 20% Duty Cycle	150 A at 15 VAC 150 A at 15 VDC	150 A at 25 VAC 130 A at 25 VDC
Welding Amperage Ranges	20-50 AC Low 50-165 AC High 30-160 DC	20-50 AC Low 35-165 AC High 25-130 DC
Max. Open-Circuit Voltage	78	78
Amps Input at Rated Output	230 V: 52 A 380 V: 39 A	230 V: 52 A 380 V: 39 A
Warranty	5/3/1 Industrial Use	5/3/1 Industrial Use
Weight, lbs.	164	164



Q
Tigmate
(Model #500425)
• AC TIG
• DC TIG
• AC stick
• DC stick

HOBART®
WELDING PRODUCTS





Catalog/Online EXCLUSIVE
A. GOWELD® Portable, Battery-Powered Professional MIG Welder.
 Weld up to 1/2-inch aluminum and steel anywhere. Uses 2 (or 3) 12-volt batteries for up to 20 minutes of weld time per charge (or as spool gun with MIG power source). Heavy-duty die cast chassis, LED power, charge and temp indicators. Computer controlled weld and system functions. Max. power rating of 42 volts DC and 200+ amps. Batteries not included. Warranted*.
 Wt. 31 lbs.
009-74977799.99



Catalog/Online EXCLUSIVE
B. Jobox® Welder's Box
 Sturdy custom storage solution for welders has a cut-out for storing tools connected to fuel tanks. Heavy-duty lockable hasp. Easy-to-use lifting handles. Model #650990. Wt. 37 lbs.
009-65761109.99



Catalog/Online EXCLUSIVE
F. Coxreels EZ-SHW-150 1/4-inch x 50-foot 200 PSI Twin Line Welding Hose Reel. Larger chassis and frame for bulky oxy-acetylene hose. Super Hub dual axle support system provides less vibration and greater structural integrity. Warranted*. Made in the USA. Wt. 64 lbs.
009-15097399.99

G. Reelcraft 25-foot Retractable Twin Line Welding Hose Reel. Spring-driven hose reel comes with 25 feet of twin hose meeting R.M.A. and C.G.A. type V.D., grade RM specifications for low pressure oxyacetylene applications. Up to 200 psi. Wt. 26 lbs.
009-20468279.99

Catalog/Online EXCLUSIVE
H. Reelcraft 50-foot Retractable Twin Line Welding Hose Reel. Spring-driven hose reel comes with 50 feet of twin hose meeting R.M.A. and C.G.A. type V.D., grade RM specifications for low pressure oxyacetylene applications. Up to 200 psi. Wt. 53 lbs.
009-20469349.99

Catalog/Online EXCLUSIVE
J. Craftsman Retractable Welding Hose Reel. Seven-position locking brace. Winding system layers hose across reel. Latching hose every 3 feet for extended use or "free run" for automatic rewinding. Universal mounting bracket, handle, flat base. 50-foot supply hose, 5-foot lead-in hose. Made in USA. Warranted*. Wt. 28.6 lbs.
009-16343269.99



VICTOR®

Catalog/Online EXCLUSIVE
C. Victor® CutSkill® PortableTote™. Rugged patented design molded plastic carry case. Welds up to 3/32 in. Cuts up to 1 1/4 in. Built-in flashback arrestors and check valves. WH 26FC welding torch. CA 25 cutting attachment. SR150 CR regulator. SR160 AR regulator. 10 cu. ft. CGA 200 acetylene cylinder. 20 cu. ft. CGA 540 oxygen cylinder. 2-UM welding nozzle. 0-3-101 cutting tip. 12 1/2 ft. x 3/16 in. Twin RM grade hose. Wt. 34 lbs.
009-47570299.99

Catalog/Online EXCLUSIVE
D. Victor® CutSkill® Medium-Duty Outfit. 250 Series regulators. Torch handle with built-in flashback arrestors and check valves. CA 270-C cutting attachment. 0-UM welding nozzle. Series 3 cutting tip. Toolbox, RM grade hose, lighter and soft-sided goggles. Cuts up to 1/2 in./12 mm (1 1/4 in./31 mm with optional tips). Welds up to 5/64 in./1.9 mm. (1 3/4 in./127 mm with optional nozzles). Wt. 16 lbs.
009-47571349.99

Catalog/Online EXCLUSIVE
E. Victor® FirePower® Welding-Cutting Outfit. Welds up to 5/64 in. and cuts up to 1/2 in. Increase welding and cutting capacity with Victor tips and nozzles. Built-in flashback arrestors and reverse-flow check valves. Includes oxygen and acetylene regulators, 3/16 in. x 12 1/2 ft. "R" grade dual hose, shade 5 goggles, striker and instruction manual. Wt. 14 lbs.
009-47572199.99



WELDING & CUTTING TOOLS, TIPS AND ACCESSORIES AT SEARS.COM/SHOPTOOLS

HOBART
WELDING PRODUCTS



K



L



M



N NEW



P NEW



Q NEW

K. Hobart Cowhide Welding Apron.
One size fits all. Model #770548. Wt. 4 lbs.
009-4757419.99

L. Hobart Premium Form-Fitted Welding Gloves. Premium natural-grain leather glove designed for comfort. Protective knuckle patches, padded palm and sturdy Kevlar® stitching. Branded pigskin cuff and backhand for comfort. Model #770440. Wt. 2 lbs.
009-3008324.99

M. Hobart Welding Jacket. 100% genuine split cowhide leather for longer wear. Double-stitched seams for extra strength. Heavy-duty snaps. Convenient front pockets. Hobart logo on chest.
009-47575 Large Model #770488. Wt. 6 lbs.49.99
009-47576 X-Large Model #770486. Wt. 6.5 lbs.49.99
009-82940 XX-Large Model #770573. Wt. 7 lbs.49.99

N. NEW Hobart Fire-Retardant Welding Jacket. Flame-retardant cotton provides superior protection. Heavy-duty snap front for welders looking for complete protection and comfort in warm climates.
009-82937 X-Large. Model #770569. Wt. 1.45 lbs.24.99
009-82936 XX-Large. Model #770568. Wt. 1.45 lbs.24.99

My Price Drop Alert **SEARS.COM/SHOPTOOLS**
Sign up to be notified when items go on sale.

Q. NEW Hobart Master Clamp Set. Ideal for turning, cutting, tightening, clamping, twisting and fabrication setup. Locking pliers and clamps feature hardened tooth designs, swivel pads and comfortable rubber grips. Sliding arm F-clamps are nearly 10X faster to setup than traditional C-clamps. Wt. 22 lbs.
009-82933179.99



Closeout Catalog/Online EXCLUSIVE
R. SAVE \$10 Craftsman Fabricator/Welding Gloves. High-density for metal fabrication work. 100% leather, suede deerskin top and fingers and three heat-resistant cowhide panels. Dual-layer knuckle band. Tough Kevlar® stitching. Comfortable hook-and-loop closure cuff. Was \$39.99 in 2008 catalog. While supplies last. Wt. 0.44 lb.
009-47562 Medium29.99
009-47563 Large29.99
009-47564 X-Large29.99

WELDING



T also available in

- 009-20816 cinder red
- 009-20557 stratto blue
- 009-20814 carbon metallic
- 009-20813 sunlit copper



S. Sellstrom® Face Shield with Shade 5 Flip Visor. A unique, multi-purpose faceshield that provides uninterrupted protection without changing protective gear. The polycarbonate IR shade 5 flip visor is lowered for brazing and flame cutting, then raised for grinding operations. Features anti-fog window and comfortable ratchet headgear. Tabs on visor allow easy lifting even with gloves. Shield meets ANSI Z87.1-2003 standards and is certified by CUL to meet CAN/CSA-Z94.3. Wt. 1.5 lbs.
009-2068539.99

Also Available
Sellstrom® Face Shield with Shade 8 Flip Visor. Wt. 1.5 lbs.
009-2081244.99

T. Sellstrom® Planet Green Hot Rod Welding Helmet. Hot Rod helmet coated with a metallflake finish. Lightweight, balanced and durable with ratchet headgear and elongated bib for added protection against weld spatter and radiant heat. Solar-powered electronic filter with lithium backup battery darkens automatically to IR shade #10. Features 4.5 sq. in. viewing area and integral retention system for magnifier plates. Meets ANSI and CUL standards. Warranted*. Wt. 2 lbs.
009-2081599.99

*Warranted, see page 94a.



CRAFTSMAN

MORE CARPENTRY AIRTOOL ACCESSORIES ONLINE AT SEARS.COM/SHOOTOOLS

Catalog/Online EXCLUSIVE

A. NEW Craftsman 4-Gallon Pancake Compressor. Compact for easy transport and storage, this handy unit features an integrated handle, 3/4-hp induction motor, belt drive oil-free pump, easy-open drain valve and single hand operation quick connect. Delivers 125 psi max, 2.7 SCFM at 40 psi and 1.7 SCFM at 90 psi. Includes 25-foot PVC contractor hose and 9-piece accessory kit. Wt. 44 lbs.
009-15215119.99

Catalog/Online EXCLUSIVE

B. NEW Craftsman 6-Gallon Pancake Compressor. 120Volt AC unit generates up to 150 PSI working pressure and longer tool usage. The 0.8 running HP belt drive motor features an oil-free pump and delivers 3.7 SCFM @ 40 and 2.6 SCFM @ 90 PSI. With thermal overload protection, convenient drain valve and quick-connect fittings, compressor includes 25-foot PVC hose, rubber feet and 9-pc. accessory kit. Wt. 40 lbs.
009-15216169.99

C. Craftsman 3-Gallon, 1-hp Air Compressor with 17-piece Accessory Kit. Oil-lubricated compressor provides lightweight, portable source of air power at 2.4 SCFM at 90 psi. Features cast iron cylinder, universal quick-connects, large rubber feet and cushioned handle. Comes with 17-piece kit with a 1/4 in. x 25 ft. coiled air hose, blow gun, spare quick-connects, dual tire chucks, sports inflation needles, tire gauge and adapters. Wt. 43 lbs.
009-15310139.99

D. Craftsman 18-gauge Flooring Stapler. Sturdy, lightweight body allows use without fatigue. Powerful gun easily drives 18-gauge 1/4 in. crown staples from 3/8 in. to 1 in. long into laminated and engineered flooring. Safety feature disables tool unless contact trip is pressed against flooring. Cushioned grip handle. Rigid nosepiece reduces jamming. Noseplate adjusts for flooring thickness. Operates at 70 to 110 psi. High-capacity 100 staple magazine for continuous operation. Wt. 2.5 lbs.
009-18169199.99

Catalog/Online EXCLUSIVE

E. Craftsman Flooring Mallet. The ideal partner for mallet-actuated nailers and staplers. Features drop forged steel head with replaceable non-marring white tip and hickory handle. Made in USA. Warranted*. Wt. 2.75 lbs.
009-3810224.99

POWERNAIL USA

THE LEADER IN FASTENING TECHNOLOGY

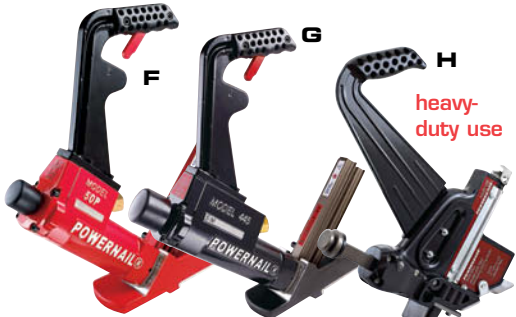

F. Powernailer® Model 50P 18-gauge Pneumatic Nailer. For 3/8 to 5/8-inch solid, bamboo and exotic wood flooring. Wt. 16 lbs.
009-18133549.99

Catalog/Online EXCLUSIVE

G. Powernailer® Model 445 Mallet Activated Pneumatic Nailer. Designed to use 1 1/2, 1 3/4, and 2-inch 16-gauge Powercleat® nails. Application – 3/4 and 33/32-in. tongue and groove hardwood flooring. Features a safety trigger. Includes mallet, extra driving blade, lubricant and wrenches. Made in USA. Wt. 18 lbs.
009-18130579.99

Also Available

PowerStapler® Model 445FS Pneumatic Floor Stapler. For 1/2 to 33/32-inch tongue and groove flooring. Uses 15 1/2-gauge PowerStaples®. Wt. 18 lbs.
009-18131579.99

Catalog/Online EXCLUSIVE

H. Powernail® Model 45R Ratcheting Nailer. Designed for heavy-duty use in nailing flooring, the ratcheting mechanism is easier to use and requires less effort than the Model 45 Nailer. Drives and countersinks cleats/nails at a perfect 45-degree angle without splitting tongue. Uses 1 1/2, 1 3/4 and 2-inch 16-gauge Powercleats®. Wt. 15 lbs.
009-15148369.99



Also Available

Powernailer® Model 200 20-gauge Pneumatic Nailer. For 5/16 to 9/16-inch engineered flooring. Wt. 16 lbs.
009-18132499.99

J. PowerJack® Model 100. Mechanically draws flooring tight together, locking in place for hands-free nailing. For use near walls and under toe-kicks. Wt. 8 lbs.
009-18134219.99

Catalog/Online EXCLUSIVE

K. NEW All-Power® Quietzone™ 4.6-Gallon, 1.5-hp Twin Tank Compressor. Quieter than an average conversation, this remarkable compressor features lightweight aluminum tanks for extreme portability. The oil-free pump delivers 125 psi max with 4.2 cfm at 90 psi. Features two easy-to-read gauges and overload protection. Wt. 49.5 lbs.
009-89545299.99



Catalog/Online EXCLUSIVE

L. NEW Campbell Hausfeld® 15-Gallon, 1.3-hp Homeowner Compressor and 7-piece Air Tool Kit. The perfect homeowner kit, combo includes air chisel, blow gun kit, tire inflator/gauge, impact wrench, spray gun, nailer/stapler with fasteners and air ratchet. Vertical compressor features oil-lubricated pump and oil sight glass. Also includes 3/8-inch x 50-foot PVC hose, 3 female and 5 male plugs. Wt. 118 lbs.
009-89548419.99

M. NEW PNI Porta-Nailer Hardwood Flooring Kit. Lightweight, durable and versatile, this kit comes ready to angle and face nail 5/8, 3/4 and 33/32-inch domestic flooring. Includes one additional shoe for nailing 5/8-inch bamboo and 3/4-inch Asian solid wood flooring and one for face nailing starter and ending strips. Single or multi-hit ratcheting ram seats nails securely to prevent squeaks. Nails designed for superior hold without splitting wood. Includes two shoes, extension handle, wide-angle nail set, mallet, wrenches, "how to" DVD and case. Made in USA. Wt. 23 lbs.

009-83010 389.99

Also Available

NEW PNI 2-inch 16-gauge Flooring T-Nail. Designed for tongue and groove wood floors, wide head and "shark-like" serrated tooth design provide the greatest impact and holding power. Cupped point cuts more easily through wood to minimize splitting. One pack includes 1,000 nails. Wt. 5 lbs.

009-83011 18.99

N. NEW Portamatic 421 Pneumatic Floor Nailer. For face and angle nailing of tongue and groove hardwood flooring. Mallet activated to ensure the tightest floor possible. Air chamber provides for rapid cycling with 90-100 psi at 4.6 cfm. 3/8-inch NPT air inlet. Drives 1 3/16, 1 1/2 and 2-inch T floor nails. Oil-free design, non-marring base, rubber hammer cap. Includes hammer, wrenches, angle and face shoes, "how to" DVD, safety glasses and case. Made in USA. Wt. 28 lbs.

009-83012 669.99

P. NEW Portamatic 470 TL Pneumatic Floor Nailer. For 1/2 inch and 3/4 inch domestic tongue and groove hardwood flooring. Mallet activated to ensure the tightest floor possible. Integrated safety prevents accidental firing. Air chamber provides for rapid cycling with 70-90 psi. 3/8-inch NPT air inlet. Drives 1 3/16, 1 1/2 and 2-inch T or L floor nails. With non-marring base and rubber hammer cap. Includes hammer, wrenches, shoe pads for 1/2 and 3/4-inch flooring, safety glasses, lube oil, case. Wt. 23 lbs.

009-83013 489.99

Q. NEW Twin Trigger 20 Stapler. The latest innovation for the installation of 1/4 to 7/16-in. solid or engineered flooring. Use either the conventional or secondary trigger to achieve the ultimate in comfort, precision and firing accuracy. Lightweight and powerful with a tool-free adjustable shoe for delivering 1-in. 20-ga. 3/16-in. crown staples. Includes safety glasses, lube oil, wrenches and case. Wt. 6 lbs.

009-83014 299.99

Also Available

NEW 1-inch 20-gauge, 3/16-in. Crown Staples. Designed for the PNI Twin Trigger 20 Stapler, and ideal for installing 1/4" to 7/16" solid and engineered tongue and groove flooring. One pack includes 5,000 staples. Wt. 6 lbs.

009-83025 16.99

R. NEW Porta Jack Pro Floor Jack. Tightens and holds flooring strips in place for nailing. Straightens crooked or bowed flooring strips and holds in place for nailing. Non-marring Teflon® base pad to protect flooring surface.

Rated for 1.5 tons of force. Features removable shoe for placement anywhere in field of flooring. Wt. 12 lbs.

009-83040 199.99



ALL NEW

SHOP ON THE GO!
Visit sears2go.com on your mobile device



All Bostitch® items on this page are **Catalog/Online EXCLUSIVE.**

S. Bostitch® Industrial Coil Roofing Nailer. Constructed of lightweight, durable magnesium. Features include a quick-load single-action side-load canister, skid-resistant pads, a toolless shingle guide and an adjustable-depth guide. Unit delivers 410 in.-lbs. of driving power and has a dry-fire lockout, so it won't fire when it runs out of nails. Carbide nosepiece inserts for long life and an overmolded rubber grip. Uses 3/4 to 1 3/4 in. nails. Model #RN46-1. Wt. 4.8 lbs.

009-18988 369.99

T. Bostitch® Paper-Tape Framing Nailer and Metal Connector. Two nailers in one, this unit features two quick-change nosepieces to convert tool to either framing or metal connector applications. Features rafter hook and patented push-button adjustable depth guide. Lightweight magnesium design for added durability. Features 1,050 in.-lbs. of driving power. Shoots 1 1/2 to 3 1/2-inch paper collated framing nails. Model #F33PT. Wt. 7.9 lbs.

009-19209 289.99

U. Bostitch® StrapShot Metal Connector Nailer. Exposed nail tip allows for a faster, more precise application. Compact design fits easily into hard to reach spaces. Up to 50% lighter than competitive models. Features 450 in.-lbs. of driving power. In-line magazine for improved balance. Drives 1 1/2-inch paper tape collated metal connector nails. Includes carrying case. Model #MCN150. Wt. 4 lbs.

009-19222 249.99

V. Bostitch® Round Head Framing Nailer and Metal Connector. Shoots 1 1/2 to 3 1/2-inch round-head plastic collated framing nails. Features interchangeable nosepieces to convert tool to either framing or metal connector applications. Features built-in 16 O.C. ruler, rafter hook and patented push-button adjustable depth guide. Lightweight magnesium design for added durability. Features 1,050 in.-lbs. of driving power. Model #F21PL. Wt. 7.9 lbs.

009-19208 289.99

W. Bostitch® 4-Gallon, 3-hp Stack Tank Compressor. Powerful 15 amp, 3 hp peak, 2.2 running hp industrial motor delivers 5.1 CFM at 40 psi and 4 CFM at 90 psi. Features durable cast iron pump cylinder and dual air outlets for running multiple tools. Takes synthetic pump oil for low-temp operation. Model #CWC200ST. Wt. 60 lbs.

009-19223 299.99

X. Bostitch® 6-Gallon, 2-hp Pancake Compressor. Featuring an efficient long-life 10.5-amp induction motor for use on 15-amp circuits. With a no-maintenance oil-free pump and compact design for maximum portability. 6-gallon tank, 3.4 CFM at 40 psi, 2.7 CFM at 90 psi. Operates from 0 to 135 psi. Rubber feet for added stability. Model #CAP2060P. Wt. 55 lbs.

009-97788 179.99

Y. Bostitch® 1/4-inch x 50-foot Polyurethane Air Hose. Rugged, lightweight air hose is chemical- and abrasion-resistant and stays flexible from -40°F to +180°F. Features 1/4-inch MPT fittings and snap-fit strain reliefs. Ribbed to prevent sticking. Model #PRO-1450. Wt. 2.16 lbs.

009-15147 34.99



Z. Bostitch® Manual Hardwood Flooring Nailer. Drives 1 1/2 to 2-in. cleat nails at a 45-degree angle every time. Selectable drive to choose either single or multi-blow operation. Installs 1/2 to 3/4-in. hardwood flooring. Kit includes graphite mallet, flooring adapters, carrying case. Model #MFN-201. Wt. 8.6 lbs.

009-97798 249.99

Also Available
1 1/2-in. Cleats. Model FLN-150. Wt. 3.25 lbs. 009-15159 18.99
2-in. Cleats. Model FLN-200. Wt. 4 lbs. 009-15160 20.99





Catalog/Online EXCLUSIVE
A. Craftsman Combination Finish/T-Head Concrete Nailer.
 • bookcases
 • tackless carpet strips
 • fencing



Catalog/Online EXCLUSIVE
B. Craftsman Coil Utility Nailer.
 • siding
 • pallets
 • sub-flooring



Catalog/Online EXCLUSIVE
C. Craftsman 16-gauge 1-inch Crown Stapler.
 • re-roofing
 • pallets
 • roofing



D. Craftsman 16-gauge Straight Finish Nailer.
 • chair rail
 • cabinets
 • molding



Catalog/Online EXCLUSIVE
E. Craftsman Fine Wire Stapler.
 • dowel and joint pinning
 • furniture
 • picture frames



Catalog/Online EXCLUSIVE
F. Craftsman Pneumatic Cable Stapler.
 • telephone/TV cable
 • computer cable
 • holiday lights

**OPEN STOCK STAPLES AND NAILS
 ONLINE AT SEARS.COM/SHOPTOOLS**



Catalog/Online EXCLUSIVE
G. Craftsman Headless Pinner.
 • decorative trim
 • dowel and joint pinning
 • picture frames



Catalog/Online EXCLUSIVE
H. Craftsman Plastic Cap Stapler
 • house wrap
 • roofing felt
 • foam boards

Craftsman Nailers and Staplers

Types	Uses	Functionality	Catalog No.
2-in-1 Nailers/Staplers	Combines the uses and functionality of the nailer and stapler in one tool. Economic and versatile.		009-18174 (Brad Nailer & Stapler) 009-18176 (Finish Nailer & Stapler)
Staplers	Fencing/Pallets/Furniture Ceiling Tiles/Insulation Upholstery/Cabinets	Staplers have greater holding power as they cover more surface area. Use to join adjacent wood pieces and securing fabrics. Note that the staples are not flush like a nail and as such are visible on the surface.	009-18410 009-18415 009-18291 009-18170 009-18171
Pinner	Decorative Trim/Dowel and Joints Small Picture Frames	Ultra small nail head for small delicate pieces. Will not split and does not require wood putty to fill in holes.	009-18292
Brad Nailers	Cabinets/Paneling/Shelving/ Chair Rails/Window Trim/Moldings/ Large Picture Frames	Great for small jobs. Easier and safer to use than hammer. Air driven brads will not split wood like a hammer and nail may. Brads are ideal for holding pieces together that have been glued.	009-18172 009-18173 (also see 009-18174 Combo Gun) 009-18654
Finishing Nailers	Chair Rail/Cabinets/Moldings/ Crates/Wood Boxes/Doghouses	Used on larger projects where longer fasteners are needed. Ideal for interior and exterior trim. Uses the widest variety of nail sizes (diameter and length).	009-18175 009-18177 (also see 009-18176 Combo Gun)
Framing Nailers	Decks/Porches/Studs/Pallets/ Fencing/Sheeting Boards/Truss	Heavy duty, professional quality tools are meant for constructing and rough framing of structures.	009-18178/009-18179 009-18214/009-18410/009-18201

Specialty Tools

There are a wide variety of specialty tools for more focused jobs: cable stapler to secure coax and speaker wires; finish nailers for carpets strips and studs fastened to concrete; plastic cap staplers to fasten roofing felt, moisture barriers and house wrap; flooring tools for laminate and engineered flooring and hardwood. Take a look and see if there is a specialty tool to make your project faster and easier to complete. Find the right tool for the right job here!

FRAMERS & NAILERS



J. Craftsman Coil Roofing Nailer.
Catalog/Online EXCLUSIVE
 • roofing
 • re-roofing
 • asphalt shingles



K. Craftsman Full Head Angle Framing Nailer.
 • framing
 • decking
 • fencing



L. Craftsman 15-gauge Angle Finish Nailer.
 • crown molding
 • window trim
 • cabinets



M. Craftsman 20-gauge 1/2-inch Crown Stapler Kit.
 • ceiling tiles
 • insulation
 • furniture



N. Craftsman 18-gauge 2-in-1 Combination Nailer/Stapler Kit.
 • bookcases
 • crafts
 • screening

Check online for **SALE PRICING!**



P. Craftsman 2-in-1 Finish Nailer Kit.
 • interior/exterior trim
 • picture frames
 • molding



Q. Craftsman 18-gauge Brad Nailer Kit.
 • chair rails
 • interior window trim
 • molding



R. Craftsman Palm-Air Driver Kit.
Catalog/Online EXCLUSIVE
 • framing applications
 • roofing applications
 • finishing applications

CARPENTRY AIR TOOLS

Craftsman Nailers and Finishers

Item	Catalog Number	Gun Body Housing	Shank Diameter or Gauge	Tool Wt., lbs.	Adj. Depth	Fastener Range	Fasteners Included	Operating Pressure	SCFM @ 90 PSI	Case	Shipping Weight	Retail	Features
A.	009-18290	Aluminum	14	4.6	Yes	1 to 2 1/4 T-Head 1 to 2 1/2 Finish	No	70-110 psi	1.41	No	5.5 lbs.	\$179.99	Drives heat-treated "T" nails into concrete and also drives 14-gauge finish nails
B.	009-18214	Magnesium	.83 to .110 in.	4.2	Yes	1 1/4 to 2 1/2 in.	No	70-110 psi	1.41	Yes	5.6 lbs.	369.99	Coil-style magazine holds 200 plastic collated or 400 wire collated nails
C.	009-18415	Aluminum	16 Ga. 1-in. Crown	5.2	Yes	1 to 1 1/2 in.	No	70-110 psi	1.41	No	6.5 lbs.	209.99	150 staple magazine, quick-release nose cover
Also Available: Craftsman 1/2-inch Crown 16-Gauge Stapler													
D.	009-18410	Aluminum	16 Ga. 1/2-in. Crown	5.2	Yes	1 to 2 in.	No	70-110 psi	1.41	No	6.5 lbs.	209.99	150 staple magazine, quick-release nose cover
E.	009-18175	Magnesium	16	3.4	Yes	3/4 to 2 1/2 in.	No	70-110 psi	1.41	No	6.5 lbs.	179.99	Quick-release nose, 360° directional exhaust
F.	009-18291	Aluminum	23, 3/8-in. Crown	2	No	1/4 to 5/8 in.	No	60-100 psi	0.1	No	2.5 lbs.	99.99	Fine wire stapler for delicate crown operations
G.	009-18182	Aluminum	Special	2	Yes	—	Yes	60-100 psi	0.67	No	3.5 lbs.	129.99	Specialty stapler drives unique fasteners to secure computer cables, stereo cable, or holiday lights
H.	009-18292	Aluminum	23	2	No	3/8 to 7/8 in.	No	60-100 psi	0.1	No	2.5 lbs.	99.99	Headless pinner, safety trigger, 200-pin magazine
I.	009-18396	Aluminum	18 Ga. 1/4 in. Crown	5.5	Yes	1/2 to 1 1/2 in.	Yes	70-110 psi	1.41	Yes	12 lbs.	199.99	Plastic cap stapler for housewrap, roof felt, foam board allows overlapping to penetrate without damage
J.	009-18180	Magnesium	0.120	3.6	Yes	3/4 to 1 3/4 in.	No	70-110 psi	1.05	Yes	7.6 lbs.	279.99	Magazine capacity is 120 nails, enough to secure one bundle of shingles; toolless adjustable shingle guide
K.	009-18178	Magnesium	.113 to .148 in.	7.4	Yes	2 to 3 1/2 in.	No	70-110 psi	2.21	No	10 lbs.	279.99	Quick-release nose cover, sequential or "bounce" fire Building codes may require full head nails
Also Available: Craftsman Clipped Head Framing Nailer													
L.	009-18179	Magnesium	.120 to .131 in.	7.4	Yes	2 to 3 1/2 in.	No	70-110 psi	2.21	No	10 lbs.	279.99	Quick-release nose cover, sequential or "bounce" fire
M.	009-18177	Magnesium	15	4.4	Yes	1 1/4 to 2 1/2 in.	No	70-110 psi	1.41	Yes	7.7 lbs.	199.99	Angle magazine, quick-release nose, sequential or "bounce" fire operation
N.	009-18170	Magnesium	20, 1/2-in. Crown	2.4	Yes	3/8 to 1 in.	Yes	60-100 psi	0.85	Yes	5.6 lbs.	109.99	1/2-in. crown staples, sequential or "bounce" fire, oilless
Also Available: Craftsman Stapler Kit													
O.	009-18171	Magnesium	18 Ga. 1/4-in. Crown	2.6	Yes	3/8 to 1 1/4 in.	Yes	60-100 psi	0.85	Yes	5.6 lbs.	99.99	Sequential or "bounce" fire operation, rear exhaust, oilless
P.	009-18174	Magnesium	18 Ga. 1/4-in. Crown/18 Ga. Brad	2.6	Yes	5/8 to 1 1/2 in./ 5/8 to 1 1/2 in./	Yes Yes	60-100 psi	0.94	Yes	6 lbs.	129.99	Quick-release nose cover to easily clear jams, drives both staples and nails, oilless
Q.	009-18176	Magnesium	18 Ga. 1/4-in. Crown Staple/ 18 Ga. Brad	2.6	Yes	5/8 to 2 in./ 16 Gauge Finish Nail	Yes Yes	60-100 psi	0.94	Yes	6 lbs.	199.99	Quick-release nose cover to easily clear jams, Magnesium body is lightweight for operator comfort Adjustable depth of drive sets nail to desired depth Includes: Case, 300 ea. 1-in. staples, 1 1/2-in. staples, 1 1/4-in. finish nails and 2-in. finish nails
Also Available: Craftsman Brad Nailer Kit													
R.	009-18172	Magnesium	18	2.6	Yes	5/8 to 2 1/8 in.	Yes	60-100 psi	0.94	Yes	6 lbs.	109.99	Sequential or "bounce" fire operation, oilless
S.	009-18173	Magnesium	18	2.6	Yes	3/8 to 1 3/8 in.	Yes	60-100 psi	0.85	Yes	5.6 lbs.	99.99	Rear exhaust, oilless operation, molded grip handle
T.	009-18201	Aluminum	16 Ga. to .148 in.	2.6	N/A	3/4 to 6 in.	No	60-110 psi	1.00	Yes	5.6 lbs.	99.99	For framing, finishing and roofing nails

CUSTOMER review

“Great overall product!!”

RPMS
Knoxville, TN



A

industrial-rated heavy-duty, right and left tilt

81-inch surface with extension

accepts 12-inch saw blade or up to 15/16 dado sold separately



Catalog/Online EXCLUSIVE

Craftsman Professional Heavy-Duty Industrial Right- and Left-Tilt Arbor Saws. Solid cast iron tables and extensions for long life even under heavy use. Rip fence positions on right or left of blade with 50-inch width of cut to right of blade and 10 1/4-inch width to the left. Quick-release rip fence rides smoothly on nylon pads. Single clamp handle locks fence to front guide rail. Screw adjustment for accurate alignment with saw blade. Front guide rail is calibrated in inches and millimeters. Cast iron miter gauge with T-roller adjusts to 30 degrees left or right. T-slot miter gauge guides on both sides of blade. Emergency mushroom-style off switch and magnetic contactor with overload relay and lock-out feature. CSA listed. Imported. Warranted*.

digital readout sold separately see page 156



Craftsman Stationary Table Saws include the performance, design principles and features typically found in industrial saws costing much more!

- Cast iron tabletops.
- Steel cabinets with totally enclosed, fan-cooled motors.
- Large, cast iron motor and arbor housing support system bolted to the cabinet to increase stability and enhance table-to-blade adjustments (A, B & C).
- Wide body, front locking, extruded aluminum fence design with Opti-Lock that keeps fence system from lifting when using fence-attached accessories (C).

A. Craftsman Professional 12-inch 3-hp Table Saw with Wooden Extension, 2 Support Legs and Right-Tilt Arbor. Powerful 3-hp motor produces quality cuts. 81 x 30 in. worksurface with extensions. Depth of cut is 4 inches at 90 degrees, 2 3/4 inches at 45 degrees. Distance in front of the blade is 12 inches. 1-inch and 5/8-inch blade arbor and 5/8-inch dado arbor included. 230-volt, single-phase 3,450 rpm motor. Measures 46D x 77W x 42H in. Wt. 720 lbs. **009-22802N◆.....1,599.99**

Also Available

Craftsman Professional 12-inch 3-hp Table Saw with Wooden Extension, 2 Support Legs and Left-Tilt Arbor. Wt. 720 lbs. **009-22803N◆.....1,599.99**

Craftsman Professional 10-inch 3-hp Table Saw with Wooden Extension, 2 Support Legs and Right-Tilt Arbor. 3-hp continuous-duty motor. 76 x 27 in. worksurface with extensions. Depth of cut is 3 inches at 90 degrees, 2 1/8 inches at 45 degrees. Distance in front of the blade is 12 inches. Includes 5/8-inch blade and dado arbors. 230-volt, single-phase, 3,450 rpm motor. 4-inch exhaust port. Measures 43D x 77W x 38H in. Wt. 540 lbs. **009-22804N◆.....1,299.99**

Craftsman Professional 10-inch 3-hp Table Saw with Wooden Extension, 2 Support Legs and Left-Tilt Arbor. Wt. 540 lbs. **009-22805N◆.....1,299.99**



B. Craftsman Professional® 10-inch 1-3/4-hp Table Saw with 12-inch Cast Iron Extension Wings. Designed to take on larger projects, this sturdy table saw features 1 3/4-hp, 120/240-volt, internal mount induction motor and a fully enclosed cabinet-style stand. Solid 12-inch cast iron extension wings and a Biesemeyer commercial fence with 30-inch right and 18-inch left rip capacities, built-in dust collection port, left-tilt arbor, miter gauge with crosscut extensions and clamp and 40T Leitz variable-pitch blade. Imported. Warranted*. Wt. 422 lbs. **009-22124N◆.....1,199.99**

C. Craftsman 10-inch 1 1/2-hp Table Saw with Cast Iron Extension Wings. Built to handle medium-size projects, this table saw features 1 1/2-hp, 120/240-volt, internal mount motor and a 3/4 cabinet-style stand. Solid 10-inch cast iron extension wings. Features large aluminum fence with Opti-Lock, 25-inch right and 24-inch left rip capacities, built-in dust collection chute, left-tilt arbor, miter gauge with crosscut extension and clamp and up-front, industrial-style push-button switch for easy access. Imported. Warranted*. Wt. 385 lbs. **009-22114N◆.....799.99**



D. Craftsman 10-inch Table Saw with Rapid Retract™ Stand. Innovative stand allows easy setup for optimum mobility. Telescoping right and left wings for a 30-inch right and 18-inch left ripping capacity. Provides cutting depth of 3 inches at 90 degrees and 2 1/2 inches at 45 degrees. Toolless leg set and blade guard for easy assembly. Dust bag mounts to stand. Rear outfeed supports piece when ripping material. Features a powerful 15-amp motor, cast aluminum table top and 10-inch, 36-tooth carbide blade for fast, smooth cuts. Built-in storage. Stand attaches to back of saw for easy mobility. Warranted*. Wt. 68.4 lbs. **009-21805** **229.99**

E. Craftsman 10-inch Portable Table Saw with Collapsible Stand. Features a folding stand and on-board handles for easy transport. 15-amp motor powers 10-inch, 36-tooth carbide blade for smooth cuts. Features sliding rails for 30 in. right and 7 in. left rip capacity. Includes sliding miter table and built-in gauge for accurate crosscuts. Rear outfeed supports piece when ripping material. Includes built-in storage, dust port and bag. Warranted*. Wt. 75.8 lbs. **009-21806** **289.99**

F. NEW Craftsman Professional 10-inch Jobsite Table Saw. Compact and portable for jobsite convenience, this powerful saw has all the features of a full-size table saw, plus a telescoping handle and 6-inch wheels. Features include new toolless blade guard, separate riving knife, right sliding table extension, rear outfeed, dust port and more. Includes 10-inch, 36-tooth carbide blade, rip fence, push stick, blade wrench, hex key and miter gauge. Warranted.* Wt. 123 lbs. **009-21828** **329.99**



EXCEPTIONAL, PORTABLE CUTTING POWER



G. DeWALT 10-inch 1 1/2-hp Table Saw with Stand. Features an exclusive, telescoping fence for up to a 24 1/2-inch rip. Rack and pinion designed fence. Powered by 15-amp high-torque motor. Comes with 10-inch, 24-tooth carbide blade, folding table stand and miter gauge. Wt. 98 lbs. **009-23448** **529.99**

*Warranted, see page 94a.
◆ See "N" suffix note on page 94a.



H. BOSCH 10-inch Worksite Table Saw with Gravity-Rise™ Wheeled Stand. Cutting-edge design for ultimate performance and portability. Smart Guard System allows superior cutting control. The Gravity-Rise™ stand offers easy set-up and take-down. Heavy-duty construction features powdercoat paint finish and 8-inch treaded pneumatic wheels. Includes 10-inch, 40-tooth carbide blade, blade wrench, hex key and miter gauge. Wt. 123 lbs. **009-23746** **649.99**



A. Craftsman 7 1/4-inch Compound Miter Saw. Ideal for miter, bevel and compound angle cuts, this compound miter saw features a dual slide rail system that allows for up to 8-inch diameter crosscut widths. Its AC-powered LaserTrac™ projects an accurate line on the workpiece for precise cuts, and the 40-tooth carbide-tipped saw blade stays sharp for clean cuts. Features dust bag, hold-down safety clamp, built-in positive miter and bevel angles and 120 volt, 5,000 rpm ball-bearing motor. Wt. 28.69 lbs. ●
009-21194.....169.99



B. Craftsman 10-inch AC Laser Sliding Compound Miter Saw. Get fast, accurate cuts up to 12 inches wide with the powerful 15-amp ball-bearing motor and A/C powered laser. Features include electric brake, aluminum die cast table and 9 positive left/right miter stops. Includes 60-T carbide-tipped blade, hold-down clamp and telescoping extensions. Wt. 52.9 lbs. ●
009-21237.....249.99

C. Craftsman 10-inch Compound Miter Saw with Stand 'N' Stow™. Innovative, portable miter saw stand stores inside base for easy transportation of saw. New, adjustable LaserTrac™ cutting guide for fast and easy setup. Multi-position twist handle for increased comfort. Dual-view bevel scale. High-visibility miter saw base graphics with 9 positive detents. Features 2 1/2-inch dust port and electric blade brake. Includes two extensions, stop block, clamp, 40-tooth carbide-tipped blade, dust bag and Stand 'N' Stow base. Wt. 53 lbs. ●
009-21238.....249.99



miter saw fits inside base for storage

D. Craftsman Professional 10-inch Sliding Compound Miter Saw with LaserTrac™. Saw features dual-bevel capability, adjustable LaserTrac™ and micro-adjustable miter for precise cuts. 15-amp ball-bearing motor tackles the toughest projects. Crown molding throat plate, stop block and sliding fences make cutting crown molding easy. Includes extra long extension bars with roller and stop, dust bag, quick-release clamp and 40-T carbide blade. Wt. 61 lbs. ●
009-21201.....449.99

E. NEW Craftsman 12-inch Sliding Compound Miter Saw. The power and capacity to tackle big projects. Saw features a 15-amp motor with electric brake, dual sliding rail system that cuts up to 12-inch boards at 90 degrees, LaserTrac™ System, telescoping extension wings and rapid release fence. Positive bevel stops at 0, 33.9 and 45 degrees. Left and right miter stops at 0, 15, 22.5, 31.6 and 45 degrees. Includes hold-down clamp and 40-tooth carbide-tipped blade. Wt. 60 lbs. ●
009-21239.....329.99

F. NEW Craftsman 12-inch Sliding Dual Bevel Compound Miter Saw. Featuring a dual slide rail system and adjustable up front support brackets, this compound miter saw has the support you need, even for your really big workpieces. Quick cam miter lock table makes it easy to change miter settings, and the LaserTrac™ projects an accurate guide line for precise miter cuts, bevel cuts, crosscuts and compound cuts. Featuring a powerful 15-amp ball-bearing motor with electric brake. Includes 12-inch, 60-tooth carbide-tipped blade, sliding fence, hold-down clamp and dust bag. Wt. 79.2 lbs. ●
009-21221.....649.99



RAGE

Catalog/Online EXCLUSIVE G. Evolution Rage3 10-inch TCT Multipurpose Sliding Compound Miter Saw. Uniquely versatile, this saw cuts steel, aluminum, pipes, wood, plastic and more with the same blade. Features rail mounting sliding blade carriage for big cross-cut capacity. Performs left/right miter cuts and left bevel cuts up to 45 degrees. Comes with Rage3 blade, box spanners and dust bag. Wt. 45 lbs. ●
009-61253.....329.99

H. Evolution Rage3 Replacement 10 Multipurpose Blade. 1-inch arbor. 28 teeth. Wt. 1.3 lbs.
009-82837.....64.99

Evolution Rage3 Specialty Blades.

J. Evolution Rage3 Diamond Tile-Cutting Blade. 1-inch arbor. Wt. 1.9 lbs.
009-82838.....45.99

K. Evolution Rage3 Wood-Cutting Blade. 1-inch arbor. 40 teeth. Wt. 1.5 lbs.
009-82839.....34.99

L. Evolution Rage3 Steel-Cutting Blade. 1-inch arbor. 52 teeth. Wt. 1.7 lbs.
009-82841.....89.99



Catalog/Online EXCLUSIVE

M. Craftsman Bench Power Tool Workstation. Lightweight and durable. Measures 33H x 67L x 25W in. and supports up to a 16-foot workpiece. Three roller supports with flip stops, two sets of quick-mount attachments, built-in power strip, work light, work vise, material supports on the legs, built-in storage and 8-in. wheel with folding legs for easy transport. Wt. 77 lbs.
009-22023249.96

Catalog/Online EXCLUSIVE

N. NEW Craftsman Folding Benchtop Tool Stand. Compact, lightweight unit sets up quickly and stand folds flat for easy storage and transport. Table conveniently adjusts from 8 to 13 inches and fits most benchtop tool-hole patterns. Incredibly lightweight, yet holds up to 200 lbs. With built-in carrying handle and non-marring feet. Dimensions: 21 x 19 x 28.5 in. Imported. Warranted*. Wt. 17.31 lbs.
009-2230979.99

P. Craftsman

Professional Adjustable Work Stand Adjusts from 28 to 36 in. high with a work surface of 638 sq. in. Compact design quickly folds up and locks. Heavy-duty steel "X" frame supports up to 400 lbs. Pre-stamped mounting slots fit a variety of benchtop tools. Dual handles with soft-grip for comfort. Two 4 in. locking casters. Safety switch and circuit breaker reset. Imported. Warranted*. Wt. 52 lbs.
009-22335159.99

Q. Craftsman Professional Universal

Bench Tool Work Stand. Provides 592 sq. in. work surface and a capacity of 300 lbs. Dual, height-adjust, ball bearing roller extensions support pieces up to 8 ft. in length. Features steel legs with cross supports, two rear 10-in. wheels and two smaller front wheels, flexible-neck work light, keyed safety switch, cord and cord wrap. Imported. Warranted*. Wt. 86 lbs.
009-22338219.99

R. Craftsman Heavy-Duty Foldable/

Portable Triple Roller Support Stand. 280 sq. in. surface supports up to 330 lbs. Quick-release button folds the stand down for easy storage. 25 x 19-in. base provides strong, stable support. 27 1/2 to 43 1/2-in. height adjustment. Imported. Wt. 34.2 lbs.
009-2226869.99

S. Craftsman Multi-Action Work

Support Stand. Three stands in one: single roller stand, multi-directional roller and stationary support. Supports up to 200 lbs. Lightweight and portable. Height is adjustable from 27 1/2 to 43 1/2 in., which allows the user to work with a variety of benchtop and free-standing tools. Imported. Warranted*. Wt. 16.8 lbs.
009-2229339.99

T. Craftsman Roller Support Stand.

Perfect support for longer projects, featuring retractable edge guides and precision metal ball bearing roller. Secures to floor for added stability. Adjusts to 43 in. high and supports up to 250 lbs. Measures 16 1/2W in. Imported. Warranted*. Wt. 13.62 lbs.
009-2229519.99

Catalog/Online EXCLUSIVE

U. Craftsman 9-Roller Support Stand. Adjusts from 24 to 44 3/4 in. high. Features nine steel rollers. Maximum 500 lbs. capacity. Measures 65L x 15W in. Imported. Warranted*. Wt. 195 lbs.
009-22242N169.99

- fold up/down supports
- adjustable worklight
- holds two bench power tools at once
- extends to support up to 16 ft. workpiece
- catalog/online exclusive
- miter saw sold separately

8-inch wheel for easy transport and switchable power strip



- compact
- lightweight
- 200 lb. capacity

N NEW

MORE TO EXPLORE
 at sears.com!



*Warranted, see page 94a.
 ♦ See "N" suffix note on page 94a.
 ● See page 94a for laser use and precautions.



A NEW



B NEW

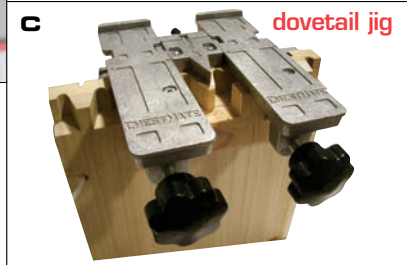

dovetail jig



D



F NEW

TRIM45



E



BLADE CHANGER

PUSH STICK



DUAL OR TANDEM FEATHERBOARD

G NEW



CRAFTSMAN

C3 sub-micrograin carbide thin kerf blades

Craftsman Bench Power Tool Accessories

Description	CRAFTSMAN	Catalog No.	Wt., lbs.	Price
A. NEW Craftsman Table Saw Digital Readout. <i>Catalog/Online EXCLUSIVE</i> Easy installation. Magnetic readout mounts anywhere and displays bevel angle within 1/10th - degree. Automatic shut-off.		009-22575	1.5	\$79.99
B. NEW Craftsman Digital Miter Gauge. Use with all bench, portable and stationary tools. Determines precise miter and bevel angles with a ± .1 degree of accuracy. Backlit digital LED screen can be read right side up or upside down. Reads angles up to ± 50 degrees. Locking handle locks miter head in position. Features 3 adjustable expansion points for a precise fit in 3/4-inch slots. 15-inch aluminum fence extends the work area and magnetic blade attachment provides blade-to-table squaring and angle adjustment. Uses 2 AAA batteries (not included).		009-29939	3.5	\$79.99

Prazi Bench Power Tool Accessories

Description	PRAZI USA	Catalog No.	Wt., lbs.	Price
C. Prazi ChestMate™ Dovetail Jig. Create dovetails with any width stock, 1/2-inch thick plus 3/4-inch 14 degree through dovetails.		009-66575	3.0	\$119.99

KREG Bench Power Tool Accessories

Description	Kreg	Catalog No.	Wt., lbs.	Price
D. Kreg Precision Miter Gauge System. Requires no calibrating. Features positive stops at 0, 10, 22 1/2 and 45 degrees and a Vernier scale for fine adjustments. Includes gauge, fence and flip stop.		009-89368	20	\$139.99

UVEX Catalog/Online EXCLUSIVE

Description	SPERIAN	Catalog No.	Wt., lbs.	Price
E. UVEX Bionic Face Shield. Extremely lightweight and balanced for all-day comfort. Features clear, anti-fog visor. Easily stands up to airborne debris and chemical splash. Adjustable to 2,784 possible positions.		009-32970	1.5	\$29.99

Milescraft Bench Power Tool Accessories

Description	MILESCRAFT	Catalog No.	Wt., lbs.	Price
F. NEW Milescraft Trim45 Trim Carpentry Aid. <i>Catalog/Online EXCLUSIVE</i> Trim doors and windows with ease. Features an adjustable reveal setting for reveals from 1/8 to 1/2 inch, perfect for any project. Includes tape measure slots, magnets and pins to ensure accurate measuring.		009-89191	0.28	\$12.99
G. NEW Milescraft Woodworking Safety Combo. <i>Catalog/Online EXCLUSIVE</i> This combo features three innovative safety accessories. The PushStick with depth gauge and docking station keeps fingers away from the cutting blade/bit, the D/T FeatherBoard comes with everything needed for dual or tandem feather board applications, and the BladeChanger keeps fingers safe and prevents damage to blade teeth when changing saw blades.		009-89192	5.0	\$49.99

Craftsman Multi-Purpose Blades Catalog/Online EXCLUSIVE

Diameter, Inches	Arbor Size, Inches	Tooth Count	Catalog Number	Wt., lbs.	Price
H. Corded Circular/Trim Saw Blades: Professional, thin-kerf, heat-treated blades with C3 sub-micrograin carbide for a hard and durable tooth. This fine grade of carbide is designed to start sharp and stay sharp throughout the life of the blade. These blades also include diamond knock-out arbors for universal use of any brand of circular saw. The deck blade is coated for superior performance in all wood, especially pressure-treated or wet lumber. Application: All types of woods (cross cuts and rip cuts).					
6 1/2	5/8 Diamond	20	009-64321	0.44	\$10.99
7 1/4	5/8 Diamond	24	009-64322	0.56	9.99
7 1/4 - 10 pack	5/8 Diamond	24	009-64323	5.00	79.99
7 1/4	5/8 Diamond - Deck	24	009-64324	0.56	11.99
7 1/4	5/8 Diamond	40	009-64325	0.63	14.99
8 1/4	5/8 Diamond	24	009-64326	0.94	14.99
J. Cordless Circular/Trim Saw Blades: Professional, thin-kerf, heat-treated, design with C3 sub-micrograin carbide for long, sharp life. Extends life of battery and ease of cut versus standard kerf blades. Application: All types of woods (cross cuts and rip cuts).					
5 1/2	1/2" - 10 mm bushing	24	009-64318	0.34	\$10.99
6 1/2	5/8	24	009-64319	0.44	10.99
6 1/2 - 10 pack	5/8	24	009-64320	3.06	89.99
K. Large Diameter Blades for Table and Miter Saws: Professional, thin-kerf, heat-treated, large diameter blades for miter and table saws. C3 sub-micrograin carbide tips for a long, durable and sharp life. 60-tooth and 100-tooth blades are stone ground for superior flatness and finish. Application: All types of woods (cross cuts and rip cuts).					
10	5/8	24	009-24119	1.63	\$24.99
10	5/8	60	009-24120	1.69	49.99
12	1	40	009-24121	2.75	49.99
12	1	100	009-24122	3.00	89.99
L. Craftsman 10-inch Saw Blade: 3-pack heat-treated and tempered for sharpness. Coated to resist heat, pitch and gum build-up. Expansion slots reduce noise and heat. Carbide blades stay sharper ten times longer than steel. Two carbide, one steel blade. Application: Wood cutting (cross cuts and rip cuts).					
10	5/8	28/40/64	009-29285	5.00	\$36.99

LUMBERJACK TOOLS

ALL THE FINEST QUALITY TOOLS
NEEDED TO MAKE LOG FURNITURE



a. Complete Log Mate System 009-64887 wt. 83.0 lbs. \$569.99



tenon mate
drill guide

drill sold separately

a. 009-64886 wt. 12 lbs. \$159.99



log mate legs

a. 009-64885 wt. 29 lbs. \$179.99

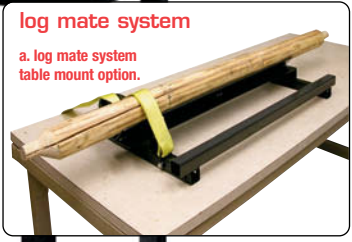

log mate system

a. log mate system
table mount option.



radius

60° tapered

**MORE LUMBERJACK TOOL ACCESSORIES
AT SEARS.COM/SHOPTOOLS**

Whether you make log furniture as a hobby or profession, Lumberjack dual-blade tenon cutters and associated products represent cutting-edge technology, resulting in the highest level of performance and value to help achieve precise results while saving time and money.

PRO SERIES – Creates a radius shoulder tenon cutters for making beds, tables, railings and more, using logs up to 3 1/2-in. dia. Designed to run on heavy-duty 1/2-in. drills.

INDUSTRIAL SERIES – Creates 60-degree tapered shoulders for making beds, tables, railings, fencing and more, using logs up to 6 1/2-in. dia. Designed to run on heavy-duty 1/2-in. drills.

REPLACEMENT BLADES – Each set contains two radius or flat hardened steel blades for use with either Pro or Industrial Series tenon cutters.

BLADE BOSS – Makes sharpening flat or radius blades quick, easy and safe.

QUICK STOP PINS – Three lengths fit Pro or Industrial Series 1, 1 1/2 and 2-in. tenon cutters to stop cut at the desired length.

COUNTERSINK BITS – Used in conjunction with Industrial Series tenon cutters to cut a 60-degree taper for a stronger joint and a more refined look.

LOG MATE SYSTEM – Versatile system for peeling, drilling, tenon making, assembling and more. Legs bolt to any surface or remove for table or workbench mounting. Drill sold separately.

LOG MATE – Mounts to bench or table and accepts up to 6-in. logs.

TENON MATE DRILL GUIDE – Attaches to Log Mate to hold drill and cutter in a fixed position for safety and consistency.

LEG KIT – Attach to Log Mate for freestanding use.

Catalog/Online EXCLUSIVE

M. Milwaukee 1660-6 1/2-inch Compact 450 rpm Drill. Made for two-handed operation with extra long handles for large hole drilling or material mixing. 1/2-in. steel capacity, 450 rpm (no-load) forward/reverse, powerful 7-amp motor, helical-cut gears are for quiet performance. Warranted*. Wt. 12.6 lbs.

009-89630 229.99



works with all
Lumberjack tools



Check online for
SALE PRICING!

*Warranted, see page 94a.

NEW Lumberjack Tools Catalog/Online EXCLUSIVE

PRO SERIES RADIUS SHOULDER TENON CUTTERS						
Catalog No.	Model No.	Description	Dia. x Length (in.)	Max. Log Dia.	Wt., lbs.	Price
009-64845	TTR0500	Radius Shoulder Tenon Cutter	1/2 x 2 1/2 Tenon	1 1/2	1.5	\$99.99
009-82875	TTR0625	Radius Shoulder Tenon Cutter	5/8 x 2 1/2 Tenon	1 1/2	1.5	119.99
009-64846	TTR0750	Radius Shoulder Tenon Cutter	3/4 x 3 Tenon	2 1/2	2.0	139.99
009-64847	TTR1000	Radius Shoulder Tenon Cutter	1 x 3 Tenon	2 1/2	2.0	149.99
009-64848	TTR1500	Radius Shoulder Tenon Cutter	1 1/2 x 4 Tenon	3	2.5	169.99
009-64849	TTR2000	Radius Shoulder Tenon Cutter	2 x 5 Tenon	3 1/2	3.0	189.99
INDUSTRIAL SERIES TAPERED SHOULDER TENON CUTTERS						
Catalog No.	Model No.	Description	Dia. x Length (in.)	Max. Log Dia.	Wt., lbs.	Price
009-64853	TTA1000	60-Degree Shoulder Tenon Cutter	1 x 3 Tenon	3 1/2	3.5	\$259.99
009-64854	TTA1500	60-Degree Shoulder Tenon Cutter	1 1/2 x 3 Tenon	4	4.0	279.99
009-64855	TTA2000	60-Degree Shoulder Tenon Cutter	2 x 3 Tenon	4 1/2	4.5	299.99
009-64856	TTA2500	60-Degree Shoulder Tenon Cutter	2 1/2 x 3 1/2 Tenon	5	5.5	379.99
009-64857	TTA3000	60-Degree Shoulder Tenon Cutter	3 x 3 1/2 Tenon	5 1/2	6.0	399.99



A

three speeds,
vise jaw swivels
up to 45 degrees

5X6- INCH
METAL

B

three speeds,
vise jaw swivels
up to 45 degrees

7X12- INCH
WET & DRY

Catalog/Online EXCLUSIVE

A. Craftsman 5 x 6-inch Horizontal Metal Cutting Band Saw. Cut ferrous and non-ferrous metals as well as steel pipe, angle iron, conduit, brass, aluminum and copper up to 5 inches diameter or 4 1/2-inch x 6-inch rectangle with this versatile saw. The 1/3-hp motor offers 3 speeds: 80-120-200 fmp. Vise jaws swivel up to 45 degrees to cut a maximum 3-inch circle or a 3 x 4 1/2-inch rectangle. Shuts off automatically after cut. Includes 64 1/2 x 1/2-inch blade. Warranted*. Wt. 112 lbs. **009-21414N◆.....349.99**

B. Craftsman Professional 7 x 12-inch Horizontal Wet-Dry Metal-Cutting Band Saw. Cuts all metals, wet or dry. 1 hp, 1,725 rpm motor. Cuts 7-inch diameter or 2 x 12-in. rectangular stock. 93 x 3/4-in. blade. Direct gear drive system with three speeds: 125, 215 or 270 feet per minute. Oversized 4 x 8 3/4-in. quick-action vise opens to 12 1/2 inches; 45-degree angle capacity. Includes hydraulic down-feed and 2-gallon coolant reservoir with submersible pump; hose nozzle; on/off valve; tubing; 6-foot, three-wire cord. 115 volt, 60 Hz AC. Measures 50L x 18W x 40H in. Imported. Warranted*. Wt. 330 lbs. **009-22612N◆.....1,199.99**

Catalog/Online EXCLUSIVE

C. Craftsman Professional 15-inch Wood and Metal Cutting Band Saw. This versatile saw tackles hardwood, plastics, metals and more. The 115/230 volt, 1 hp motor offers four speeds: 80, 150, 200 and 3,000 fpm. The 15 x 15 in. cast iron table includes cast iron fence and miter gauge. Features 14 5/8-inch throat capacity and 10-inch max. cutting height. Takes 3/16 to 3/4W x 112 to 114L in. blades. Imported. Warranted*. Wt. 215 lbs. **009-22440N◆.....1,099.99**

Also Available

15-inch Metal Cutting Band Saw. 80 to 350 rpm blade speed. Does not include blade welder. Wt. 603 lbs. **009-21431N◆.....2,899.99**

D. Craftsman Professional 18-inch Industrial Metal Cutting Band Saw with Blade Welder. Featuring a 115/230-volt, 1 1/2-hp motor with industrial rated speed reducer, this saw features a 21 x 23 in. cast iron table and a blade welder to cut and weld blade. Table tilts 15 degrees left/right, 80 to 385 rpm blade speed. Imported. Warranted*. Wt. 1,012 lbs.

009-21430N◆.....3,899.99

Also Available

Craftsman Professional 18-inch Wood and Metal Cutting Band Saw. Dual function offers versatility for homeowners and shops. The 115/230 volt, 1 1/2 hp motor offers four speeds: 80, 150, 220 and 3,000 fpm. With 12-inch resaw capacity, it takes 3/16 to 1W x 135 to 137L in. blades. Imported. Warranted*. Wt. 280 lbs. **009-22450N◆.....1,399.99**

**100'S OF BAND SAW BLADES
AT SEARS.COM/SHOPTOOLS**



BAND SAWS FOR THE PROFESSIONAL

BENCH POWER TOOLS



E. Craftsman 12-inch Band Saw. Features steel frames with cast iron tables. Built-in dust port for attaching wet/dry vacs. Fence and blade guide bearings. Powerful 3/4 hp motor delivers cutting speeds of 1,450/3,000 feet per minute. 12 x 7 in. throat provides a large cutting capacity; cuts wood up to 7 inches thick and 12 inches wide. Table tilts up to 45 degrees for bevel cutting. Also features micro adjustable ball-bearing guides, built-in light, tracking window, blade tension gauge and 9-spoke wheels. Uses 89 1/2 in. blades. Includes open stand. Wt. 175 lbs.

009-22400N ♦ **399.99**

Also Available

Craftsman Professional 14-inch Band Saw. Steel frame construction for reduced deflection under full blade tension. Upper and lower blade bearing guides reduce friction. Blade tension and tracking windows let you view the blade tension and tracking without opening doors. Cast iron wheels. Table tilts 0 to 45 degrees to left for angle cutting. Includes tire cleaning brush, table fence, work light, dust port. Wt. 223.8 lbs.

009-22401N ♦ **559.99**

15-INCH

18-INCH

12-INCH

SEARS.COM/SHOPTOOLS
 Sign up to be notified when items go on sale.

*Warranted, see page 94a.
 ♦ See "N" suffix note on page 94a.

CRAFTSMAN[®]

COMPUCARVE™ 3-D WOODWORKING MACHINE

A. GREAT VALUE CHECK OUT THE TUTORIAL VIDEO AT SEARS.COM/SHOPTOOLS

A. Craftsman CompuCarve™ 3-D Woodworking Machine.
Execute stunning carvings, scrollwork, as well as ripping, cross-cutting, mitering, contouring, jointing and routing functions with a single tool. This compact, computer-controlled machine, coupled with easy-to-use software, allows anyone to craft wood and other soft materials like a pro.

The Machine
Patented rising-head and feed-through design that handles workpieces up to 14 1/2 inches wide, 5 inches high and almost any length. Basic functions such as edge routing, jointing, mitering and beveling are already programmed into the machine. Designs you create using the CarveWright™ software are saved to a memory card and inserted into the machine while the LCD display walks you through, step by easy step.

The Software
The CarveWright™ design software features a simple point-and-click interface that lets you choose from an extensive library of 3-D design elements. Once arranged, combine or alter them to fit your project. Import and manipulate images to suit your needs or draw out your own designs using 2-D drawing capabilities.

The Results
CompuCarve™ Includes 1/16 in. carving and 1/8 in. carbide cutting bits, memory card, starter software, 2 1/4 in. bit adaptors, vacuum bag adaptor, bit removal tool, hex wrench, manual and Quick-Start Guide. Wt. 81 lbs.
009-21754 1,999.99

Also Available
Full Bit Set. Wt. 1.8 lbs.
009-21781 399.99

B. Surface Scanning Probe. This 3-D scanning probe enables height mapping of existing surfaces and objects to be imported into the CarveWright™ software libraries. Use with the CompuCarve™. Wt. 0.2 lb.
009-21778 329.99

C. Craftsman 16-inch Variable Speed Scroll Saw. Sturdy cast iron table minimizes vibration and allows left tilt 45 degree bevel cuts. Takes 5-inch pinned and plain-end blades. Variable speeds of 400 to 1,600 spm cut up to 2 inches at 90 degrees and up to 1 inch at 45 degrees. Adjustable blower keeps work area clear. Built-in 1 1/4-inch vacuum port. Wt. 35 lbs.
009-21602 119.99

D. Craftsman 18-inch Scroll Saw. On/off foot pedal for superior control. The 18-inch throat depth allows more versatility on larger projects. Offers variable speed of 0 to 1,700 spm and bevels 45 degrees left and 5 degrees right. Blower and worklight are integrated to move simultaneously. Features removable throat plate, toolless blade change and up-front top-mounted controls. Includes two pin type and three plain-end blades. Wt. 35.5 lbs.
009-21609 219.99

E. Craftsman Professional 16-inch Variable-Speed Tilting Arm Scroll Saw with Dust Collection. Tilting arm keeps workpiece flat and stable. Cuts through hardwoods, softwoods, plastics and non-ferrous metals. Variable-speed control delivers 300 to 1,400 spm. Innovative design features a tilting arm with a 90 to 45 degree range and dust collector. Takes 5-inch pin type blades. Features "Mechanical" variable-speed control and worklight for easy setup. Imported. Warranted*. Wt. 76 lbs.
009-21612 299.99

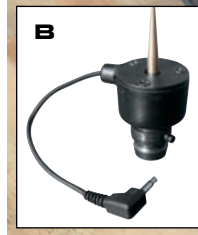

Watch the online video to learn how you can create your own designs on your PC or laptop!



TONY'S PICK

MORE COMPUCARVE BITS AT SEARS.COM/SHOPTOOLS



18-inch with foot pedal

16-inch variable-speed

INCLUDES CASE



F



G



H NEW

ROCKWELL

BENCH POWER TOOLS

Catalog/Online EXCLUSIVE

F. Craftsman 6-inch Cutoff Saw. Quickly cuts conduit, steel pipe, drywall studs, PVC and rebar with 3.5 amp universal motor and 6-inch abrasive wheel. Head lock-down chain and handle make the saw portable. Cuts up to 2-inch round stock, 7,500 rpm. Includes carrying case, two extra abrasive wheels and adjustment tools. Imported. Warranted*. Wt. 11 lbs.
009-26850 **89.99**

G. Craftsman 14-inch Abrasive Chop Saw with

Laser Guide. Powerful 15-amp motor delivers clean, precise cuts on heavy-duty jobs. Laser guide ensures accuracy. Quick-release vise swivels 45 degrees. Cast iron base. Includes extensions. Wt. 50 lbs. ♦
009-21289 **219.99**

Catalog/Online EXCLUSIVE

H. NEW Rockwell® 14-inch Cut-Off Saw. Powerful 15-amp motor with electric brake and durable all-metal lower guard for added protection. Features quick release clamp, lightweight steel base and spindle lock for easy blade changes. Large loop handle for easy operation. Lock-down chain for compact, safe transport. Wt. 44.09 lbs.
009-89183 **169.99**

Catalog/Online EXCLUSIVE

J. Evolution Rage2 14-inch TCT Multipurpose Chop Saw. This incredible cut-off saw outperforms abrasive saws. Featuring patented RAGE² technology, utilizing a TCT blade rather than an abrasive wheel. Plus it has the ability to cut steel, aluminum and wood with a single blade. Fast cuts require no coolant with no burr and virtually no sparks. Delivers up to 1,000 cuts in 1/4-inch mild steel before a replacement blade is needed. Comes with Rage2 blade and hex keys. Warranted*. Wt. 61 lbs.
009-61252 **279.99**

K. Evolution Rage2 Replacement 14-inch Multipurpose Blade.

1-inch arbor. 36 teeth. Wt. 3.4 lbs.
009-82842 **75.99**

Catalog/Online EXCLUSIVE

L. Evolution Rage4 7 1/4-inch TCT Multipurpose Chop Saw. Extremely effective, yet very portable, this versatile chop saw cuts quickly and cleanly through steel, aluminum, wood and plastic using one blade. Cuts steel cold with minimum sparks and burrs. Wt. 19 lbs.
009-82729 **179.99**

M. Evolution Rage4 Replacement 7 1/4-inch Multipurpose Blade.

20 mm arbor. 20 teeth. Wt. 0.6 lb.
009-61359 **24.99**



14-INCH



7 1/4 INCH



Evolution Rage Chop Saw Specialty Blades

Application	Arbor Hole	Teeth	Cat. Number	Wt., lbs.	Price
Diamond Masonry	1 inch	0	009-82843	4.4	\$59.99
Stainless Steel Cutting	1 inch	90	009-82844	3.8	125.99
Aluminum Cutting	1 inch	80	009-82845	3.8	111.99
Wood Cutting	1 inch	60	009-82849	3.65	69.99
Steel Cutting	1 inch	66	009-82850	3.8	99.99

See page 182 for additional Rage4 blades.

*Warranted, see page 94a.

♦ See "N" suffix note on page 94a.

♦ See page 94a for laser use and precautions.

M

N. Craftsman Professional LaserTrac™

10-inch Radial Arm Saw. Laser ensures accurate cuts. Features "control cut" trigger to ensure consistent rate of cut. Sturdy 27W x 40L in. MDF worksurface for larger workpieces. Rugged stamped steel stand features non-skid adjustable feet. Automatic brake stops blade in seconds. Includes 10-in. x 40T carbide blade. Dual-voltage 1.5 hp (3 hp maximum developed) induction motor. Imported. Warranted*. Wt. 204 lbs. ♦
009-22010N **749.99**

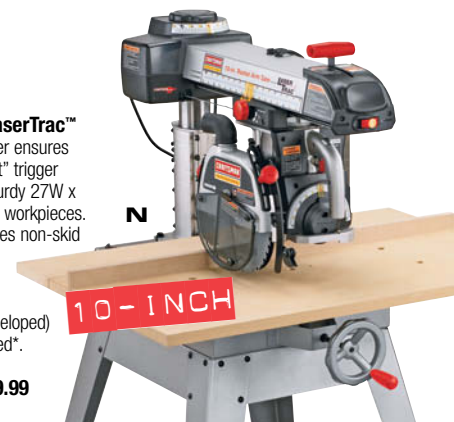

10-INCH

N

SHOP ON THE GO!
 Visit sears2go.com on your mobile device

BENCH POWER TOOLS

THE FEATURES YOU NEED — THE PERFORMANCE YOU EXPECT



Catalog/Online EXCLUSIVE
A. Craftsman Professional 3-Blade Planer with Built-in Dust Collector. This planer provides performance as well as features. 3-blade cutterhead, 2-speed auto-feed, 8,000 rpm cutterhead speed and 4 lead screw design produce a finish that may not need sanding. Digital readout for accurate finished piece dimensions. Built-in dust collector helps reduce harmful dust particles in the air. Also includes: preset depth gauge, workpiece return rollers and infeed/outfeed extension tables. Imported. Wt. 105 lbs.
009-21759N ♦\$549.99



compact 4 1/8-inch model



built-in digital read-out



A & C include oversized dust bag

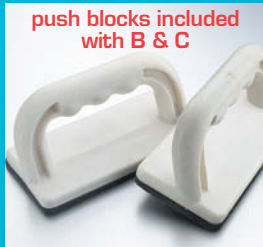

push blocks included with B & C

Catalog/Online EXCLUSIVE
B. Craftsman 4 1/8-inch Jointer/Planer. Compact, portable, lightweight design makes this a great tool for your shop. Cast iron table provides smooth, even cuts. Fence tilts 90° to 45° for bevel cutting. Precision table height adjustment with lock. Two 4 1/8-in. wide double-edge HSS blades. Includes two push blocks and locking rocker switch. Imported. Wt. 44 lbs.
009-21762\$159.99

CUSTOMER review

“This is a great planer. I would recommend this planer to anyone.”
 SatisfiedWoodworker
 East Bay Area, CA

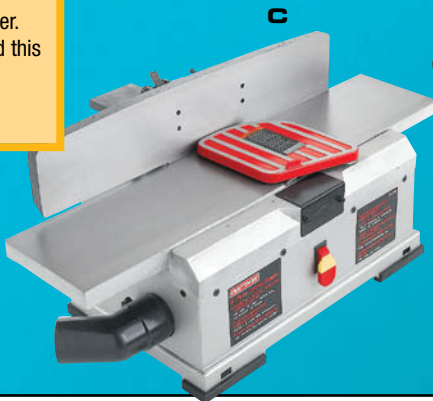

C. Craftsman 6 1/8-inch Jointer/Planer with Built-in Dust Collector. 12-amp motor provides power to plane boards up to 6 1/8 in. wide. Two blades with cutterhead speed of 8,000 rpm for 16,000 cpm. Cast iron table and fence produce professional cuts every time. Fence tilts 45° inward to 45° outward (with positive stops) for a variety of cuts. Includes two push blocks and 1/2 bag for the dust collector. Wt. 87 lbs.
009-21788\$279.99

D. Craftsman 12 1/2-inch Planer. Plane boards up to 12 1/2 inches wide and up to 6 inches thick. Lightweight and portable with two extension tables that fold up for storage. Two HSS double-edge blades use an index pin system so a knife setting gauge is not required. Auto feed rate 26 fpm. 12-amp, 9,400 rpm unit has 2 blades for 18,800 cpm. Reversible dust collection port for left or right side operation. Wt. 65 lbs.
009-21758\$279.99

Catalog/Online EXCLUSIVE
E. Craftsman Professional 15-inch Planer. Plane boards up to 15 inches wide and 6 inches thick. Features cast iron extension wings and head and digital readout for accurate workpiece dimensioning. With three blades and a 3 hp 230V single-phase motor, planer develops 5,000 rpm for 15,000 cuts per minute. Auto feed rate 16 or 25 fpm. Four-post lead screw design with lock. Dust collector port. Wt. 500 lbs.
009-21702\$1,399.99
Replacement Blades for 009-21758. Wt. 1.1 lbs. 009-21770\$25.99
Replacement Blades for 009-21762. Wt. 0.3 lb. 009-21791\$14.99
Replacement Blades for 009-21788. Wt. 0.3 lb. 009-22994\$14.99
Replacement Blades for 009-21759. Wt. 0.3 lb. 009-21790\$39.99

PLANER BLADES AND ACCESSORIES AVAILABLE AT SEARS.COM/SHOOTOOLS



*Warranted, see page 94a.
 ♦ See “N” suffix note on page 94a.

CRAFTSMAN PROFESSIONAL JOINTERS/PLANERS



G. Craftsman Professional 6 1/8-inch Jointer/Planer.

Enhanced design features powerful 1 1/2 hp continuous-duty motor. Cuts up to 1/8-inch deep with 3-blade cutterhead. 1 1/2-inch deep rabbeting. Cast iron fence tilts 45° inward/outward for bevel and chamfer cuts. 4-inch diameter exhaust port, industrial-style pushbutton switch, includes two push blocks and enclosed stand.

Catalog/Online EXCLUSIVE

H. Craftsman Professional 8-inch Jointer. Powered by 2 hp, 3,450 rpm, 230V motor. 9 1/4W x 70L precision-machined cast iron table provides precision cuts for a lifetime. 5H x 40L inch cast iron fence tilts 45° inward to 45° outward. Three HSS blades are resharpenable and include knife setting gauge. Includes 4-inch chip chute and two push blocks.



Jointers / Planers

Item	Catalog Number	Max. Cut Width, in.	Max. Cut Height, in.	HP or Amps	Blade Quantity/ Reversible	Cutterhead RPM	Cuts Per Minute	Auto Feed Rate	Cast Iron Table	Fence	Dust Collector	Wt., lbs.	Price
G.	009-21705N◆	6 1/8	—	1 1/2 hp	3/No	5,000	15,000	—	Yes	Cast Iron	No	243	\$579.99
H.	009-21703N◆	8 1/8	—	2 hp	3/No	5,000	15,000	—	Yes	Cast Iron	No	458	1,199.99

Catalog/Online EXCLUSIVE

J. Craftsman Mini Lathe. Compact yet powerful lathe offers a 12-in. spindle capacity with a 4-in. bowl-turning capacity. 1.4-amp, three-speed motor turns at 1,350, 2,250 and 3,500 rpm (no-load) for rough to fine finishing. Features #1MT spindle and tailstock taper and ratchet-style locking handles. Includes eye shield, face plate, wrench, tool rest, spur center, bearing center and pen mandrel. Wt. 12 lbs.

009-22106 179.99

Catalog/Online EXCLUSIVE

K. Craftsman 3-piece Mini Turning Set. Excellent for turning pens. Includes 8 mm spindle gouge, 1/2-inch skew chisel and 1/16-in. parting tool. Includes wooden storage box. Wt. 1.2 lbs.

009-29818 39.99

Catalog/Online EXCLUSIVE

L. Craftsman 6-piece Turning Tool Set. Comfortable handles for balance and control, the finely polished blades, forged from high-speed steel, stay sharp 6 times longer than carbon steel blades. Wt. 4 lbs.

009-28596 99.99



England's Premiere Manufacturer

of specialist woodworking tools with a heritage dating back over two hundred years. From their factory in Sheffield, England, they produce an extensive selection of high-quality wood turning, wood carving and woodworkers' tools. These are much sought after in all corners of the world.

Robert Sorby

Catalog/Online EXCLUSIVE

M. Robert Sorby 6-piece Beginners' Woodturning Tool Set. A full-sized set good for any type of turning, from bowls to spindles. Includes 3/4-in. oval skew, 3/4-in. roughing gouge, 1/2-in. round nose scraper, 3/8-in. spindle gouge, 3/8-in. bowl gouge, and 1/4-in. parting tool. Wt. 5 lbs.

009-83220 319.99

Catalog/Online EXCLUSIVE

N. Robert Sorby 6-piece Carving Chisel Set. With razor-sharp cutting edges and hand-polished ash shock-absorbing handles, this set contains 3/8-in. skew chisel; 3/8-in. bent gouge; 1/2, 1/4 and 1/8-in. straight gouges; and 1/8-in. parting tool. Wt. 1.5 lbs.

009-83222 289.99

Catalog/Online EXCLUSIVE

P. Robert Sorby 5-piece Micro Turning Set. For finely detailed work like small boxes and vessels up to 4 in. Use on small lathes where bigger tools are inappropriate. Tools are 10 inches long and include 5/16-in. roughing gouge, 1/4-in. spindle gouge, 1/4-in. round nose scraper, 1/4-in. skew chisel, and 1/16-in. parting tool. Wt. 1 lb.

009-83221 149.99

Catalog/Online EXCLUSIVE

Q. Robert Sorby 6-piece Micro Carving Chisel Set. With highly polished, honed and buffed blades and comfortable ergonomically shaped handles, this set includes square, skew and dog leg chisels, straight and bent gouges, and parting tool. All tools are 6 1/2 in. long. Wt. 0.8 lb.

009-83223 189.99

M

N

P

Q

DRILL PRESSES

Catalog/Online EXCLUSIVE

A. Craftsman Professional 12-Speed Industrial Milling/Drilling Machine with Stand. Features drilling capability in addition to boring, end and face milling. Powered by a 1 1/2-hp, 115/230-VAC motor that delivers 1,725 rpm. Table features four 5/8-inch T-slots and adjustable collars with .001-inch gradations. X-axis travels 19 3/4 inches, Y-axis travels 7 inches. Includes R8 spindle to J3 adapter, 3-inch face cutter with arbor, 5/8-inch chuck and key, worklight and 14-gauge steel stand. Imported. Wt. 796 lbs.

009-21197N ♦ 2,299.99

Catalog/Online EXCLUSIVE

B. Craftsman Professional 20-inch Stationary Drill Press. Solid, industrial-quality drill features 1-hp continuous-duty motor that delivers 150 to 2,200 rpm. Features large cast iron head and production table for stability. Includes industrial-style push-button switch and external depth stop with quick-change nut. Offers 9 spindle speeds, three-spoke quill handle, 3/4-inch capacity keyed chuck and an adjustable worklight. Imported. Warranted*. Wt. 324 lbs.

009-22902N ♦ 739.99

C. Craftsman Digital 12-inch Bench Top LaserTrac® Drill Press. Designed for precision and smooth performance, this sturdy tool comes complete with digital depth readout and laser guide for accuracy. Features adjustable fence for repetitive work and rack-and-pinion for accurate height adjustments. Offers 5 spindle speeds, swivel knob, 1/2-inch chuck and an adjustable LED worklight. Imported. Warranted*.

Wt. 97.1 lbs. ♦ 219.99
009-21914 219.99



industrial rated

12 SPEED



20-INCH

Check online for
SALE PRICING!

D and E. Craftsman Stationary Laser-Guided Drill Presses. Updated design features large cast iron head casting, flat slotted cast iron table for easy clamping and column-mounted laser for unparalleled accuracy.

D. Craftsman 15-inch Stationary Laser Drill Press. 1/2-hp continuous-duty motor delivers 300 to 3,100 rpm. Includes removable toggle switch and external depth stop with double nut. Offers 12-spindle speeds, a left/right mounting three-spoke quill handle, a 5/8-inch keyless chuck and an adjustable work light. Imported. Wt. 174 lbs. ♦ 429.99

E. Craftsman Professional 17-inch Stationary Laser Drill Press. Industrial-style drill features 3/4-hp continuous-duty motor delivers 215 to 2,720 rpm. Includes industrial-style push-button switch, expandable work supports and external depth stop with quick-change nut. Offers 16 spindle speeds, single-arm adjustable quill handle, a 5/8-inch keyless chuck and an adjustable worklight. Imported. Wt. 206 lbs. ♦ 599.99



12-INCH

digital read-out



15-INCH

17-INCH

LASER TRAC

*Warranted, see page 94a.
♦ See "N" suffix note on page 94a.
♦ See page 94a for laser use and precautions.



F. Craftsman Hollow Chisel Mortiser. Cut accurate mortises for snug-fitting mortise and tenon joints. Powerful 1/2-hp, 120-volt motor develops maximum speed of 1,725 rpm. Features full-size cast iron base and large fence with micro-set adjustments for easy set-ups. Cuts stock up to 4 1/2 inches thick. Multi-positional feed handle mounts left or right. Keyed chuck for easy bit changes. Toggle switch with removable key guards against unauthorized use. Includes four chisel and bit sets (1/4, 5/16, 3/8 and 1/2 in.). Offers adjustable depth stop rod and chuck extensions for various length bits. Imported. Warranted*. Wt. 73.7 lbs.
009-21907279.99



G. Craftsman Compound Milling Table and U-Bolt Clamp Set. Table surface is 18 5/8W x 6L in. with 9/16-inch T-slots, center to center is 2 9/16 in. Horizontal movement is 12 inches and cross movement is 8 inches. One revolution of the crank handle gives 0.0787 inch movement. Scale to 0.0008 inch index. Two-piece U-bolt clamp set has "T" nuts that fit 9/16-inch slots of milling table. Clamps can also be used with all open-slotted drill press tables. Milling table can be used with all floor model drill presses. Imported. Warranted*. Wt. 61 lbs.
009-27593.....219.99



POWER TOOL ACCESSORIES AT SEARS.COM/SHOPTOOLS

CRAFTSMAN®

MECHANIC'S VISES AND CLAMPS

Craftsman Vises						
Size	Jaw width, in.	Jaw opening, in.	Throat depth, in.	Catalog Number	Wt., lbs.	Price
J. Craftsman Cross Vise. With 5-in. cross travel; 5-in. longitudinal travel. Precision-machined dovetails for smooth, accurate operation of longitudinal and cross travel.						
3	3	3	1 3/8	009-24087	17.5	\$79.99
Craftsman Cross Vise. With 8-in. cross travel; 8-in. longitudinal travel.						
6	6	6	2	009-24089	64	149.99
Craftsman Cross Vise. With 8-in. cross travel; 8-in. longitudinal travel.						
8	8	8	2	009-24091	95	199.99
K. Craftsman Side-plate Angle Vise. Body scale of 0° to 90° side plates to securely lock angle. 4,000 lbs. clamping force.						
4	4	4	1 3/4	009-24085	27.3	99.99
L. Craftsman Quick Grip/Release Vises. Cam action quick-release mechanism for repetitive operations. Open center base for through drilling.						
3	3	3	1 1/8	009-24079	10	39.99
4	4	4	1 3/8	009-24081	20.3	99.99
M. Craftsman General Purpose Vises. Axial sleeve bar, machined and ground from alloy steel to maintain parallel movement.						
3	3	3	1 1/8	009-24071	9.3	34.99
4	4	4	1 3/4	009-24073	14.7	49.99
6	6	6	2	009-24075	31	79.99
8	8	8	2	009-24077	48	99.99
N. Craftsman Cradle Angle Vise. Scale from 0° to 90° alignment pin for standard angles and quick set-up.						
3	3	3	1 3/8	009-24083	11.9	44.99
P. Craftsman Machinist's Vises. Machined on 4 sides for horizontal or vertical operation.						
4	4	4	1 1/2	009-24093	9.4	49.99
6	6	6	2	009-24095	25	79.99

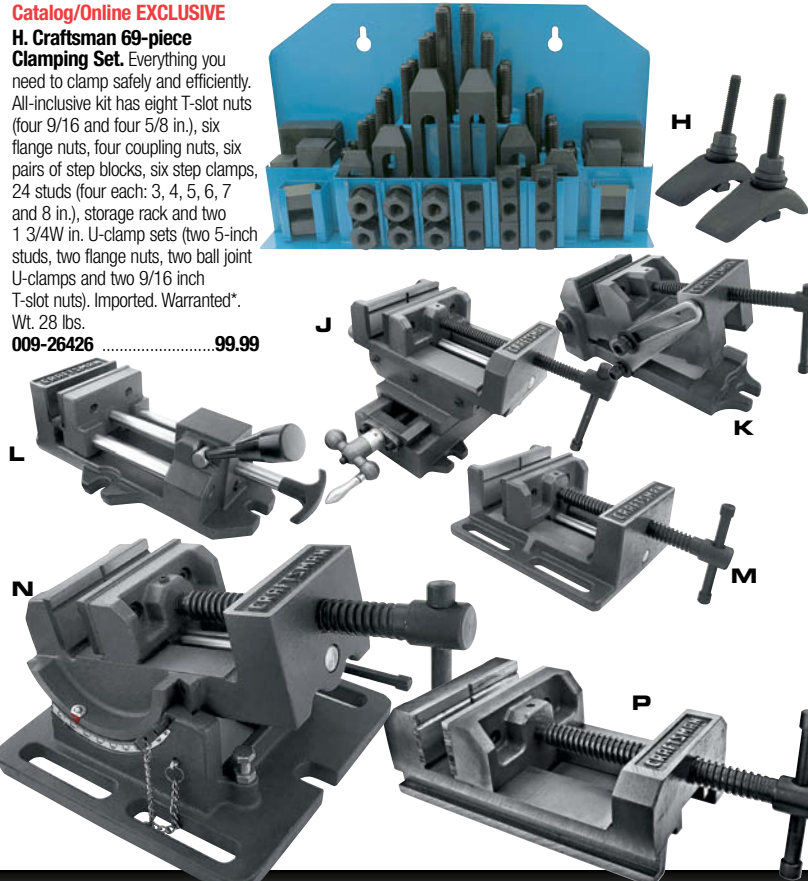

Catalog/Online EXCLUSIVE
H. Craftsman 69-piece Clamping Set. Everything you need to clamp safely and efficiently. All-inclusive kit has eight T-slot nuts (four 9/16 and four 5/8 in.), six flange nuts, four coupling nuts, six pairs of step blocks, six step clamps, 24 studs (four each: 3, 4, 5, 6, 7 and 8 in.), storage rack and two 1 3/4W in. U-clamp sets (two 5-inch studs, two flange nuts, two ball joint U-clamps and two 9/16 inch T-slot nuts). Imported. Warranted*. Wt. 28 lbs.
009-2642699.99

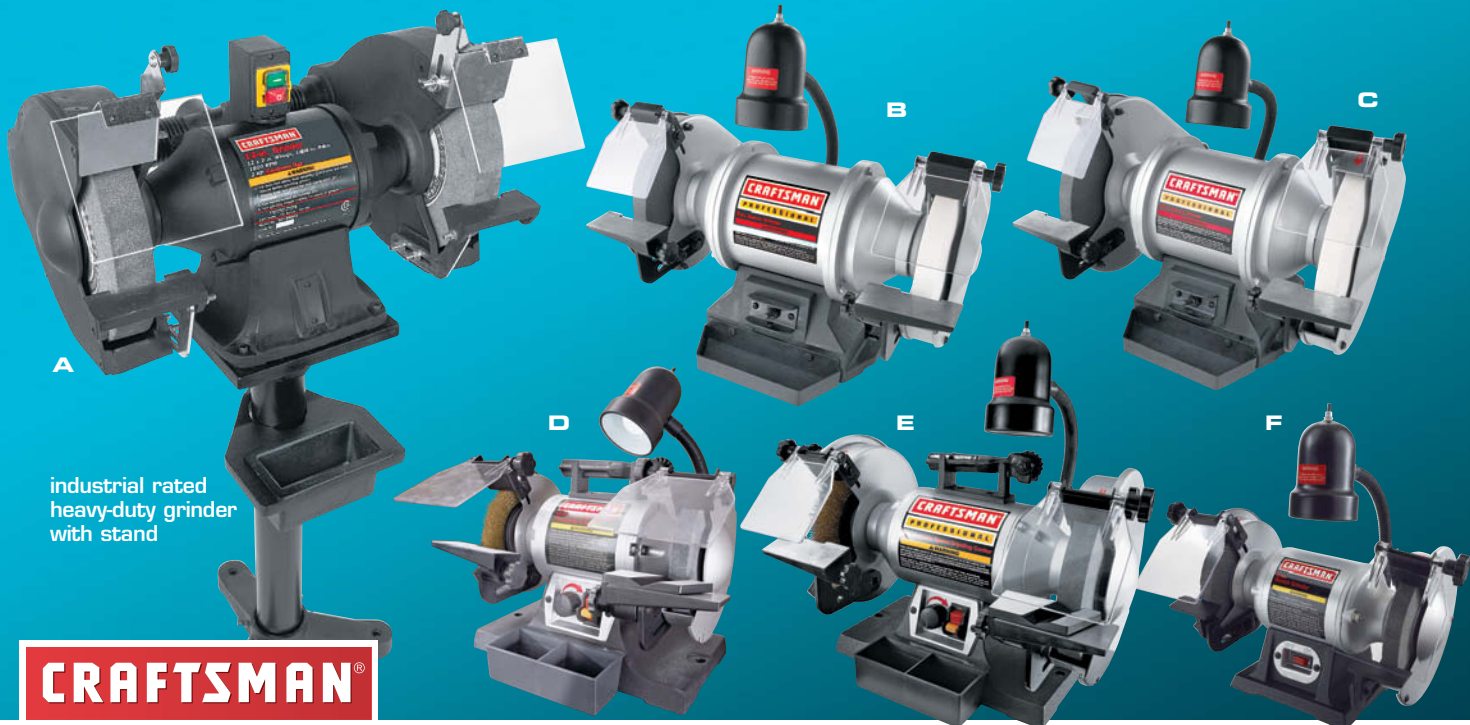

industrial rated heavy-duty grinder with stand

CRAFTSMAN

Catalog/Online EXCLUSIVE

A. Craftsman Professional 12-inch Industrial Bench Grinder with Stand. Powered by a 2 hp, 230/460 VAC motor that delivers 1,800 rpm. Features cast iron base and end shields, eye shields and wheel guards for heavy-duty use. The 12-inch abrasive wheels feature a 1 1/4-inch face. Includes cast iron/steel stand. Wt. 310 lbs.
009-21196N **1,099.99**

Catalog/Online EXCLUSIVE

B and C. Craftsman Professional Industrial Bench Grinders. Designed for heavy-duty grinding, these machines have cast iron bases and motor housings to dampen vibration. Each features an independently operating lamp, adjustable cast aluminum tool rests, 60-grit medium and 120-grit fine grinding wheels, wheel dresser, coolant tray, large eye shield, spark arrestors and exhaust ports. CSA listed. Imported. Warranted*.

B. Craftsman Professional 8-inch Industrial Bench Grinder. Features a 3/4 hp motor that develops 3,450 rpm. Ideal for use on knives, keen-edge tools and finishing and polishing. 8-inch wheels with a 1-inch face. Removable toggle switch. Wt. 98 lbs.
009-22018 **229.99**

C. Craftsman Professional 10-inch Industrial Bench Grinder. For drill bits, chisels, shears and more. With a powerful 1 hp motor that operates at 1,725 rpm. 10-inch wheels with a 1-inch face. Removable toggle switch. Wt. 121.8 lbs.
009-22060N **349.99**

D. Craftsman 6-inch Variable-Speed Grinding Center. Features quick-change wheel guards. Accurate speed range of 2,000 to 3,450 rpm for grinding or deburring projects. Large cast iron base adds stability. Includes top-mounted wheel dresser, water cooling tray, flexible lamp with independent on/off switch, wire and grinding wheel. Large, U-shaped adjustable tool rests with patented attachment for accurate bit sharpening. Imported. Warranted*. Wt. 30.8 lbs.
009-21154 **99.99**

E. Craftsman Professional 8-inch Variable-Speed Bench Grinder. Variable speed control 1,725-3,450 rpm for a variety of grinding applications. Features quick-change wheel guards, flexible worklight with independent switch and solid cast iron base. Large, U-shaped adjustable tool rests with patented attachment for accurate bit sharpening. Wide, clear eye shields and sturdy spark guards. Warranted*. Wt. 47.3 lbs.
009-21162 **159.99**

Also Available
Craftsman Heavy-Duty Grinding Wheel Dresser. Face measures .930-inches. Features seven hardened star-tooth cutters and three spacers in a cast iron body. Wt. 6 lbs.
009-25283 **19.99**

F. Craftsman 6-inch Bench Grinder. Powered by a 1/3 hp maximum developed motor. Flexible lamp attachment with an independent on/off switch. Cast iron base and two-piece tool rests. Clear, wide eyeshields. Lighted on/off rocker switch. Includes 60-grit medium and 36-grit coarse grinding wheel. Imported. Warranted*. Wt. 22 lbs.
009-21124 **64.99**

Also Available
Catalog/Online EXCLUSIVE
Craftsman Grinding Wheel Dresser. For use with grinding wheels up to 2 inches wide. Face measures .450-inches. Features four hardened star-tooth cutters and two spacers in a cast iron body. Wt. 1.4 lbs.
009-25282 **14.99**

MORE TO EXPLORE
 at sears.com!

G NEW

ROCKWELL



FIND COMPLETE BUFFING & GRINDING ACCESSORIES AT SEARS.COM/SHOPTOOLS

*Warranted, see page 94a.
 ♦See "N" suffix note on page 94a.

Catalog/Online EXCLUSIVE
G. NEW Rockwell® 8-inch 3/4 hp, 5-amp Bench Grinder. 3/4 hp grinder includes upgrade on-board tool storage, built-in work lights and magnifying eye shields for more accurate, efficient grinding. Spindle lock for easy wheel changes. Integrated tool rests for more precision and accurate grinding. Wt. 51.81 lbs.
009-89190 **129.99**

Catalog/Online EXCLUSIVE
H. Craftsman WheelEzze™. Silicon carbide grinding wheel dressing stick for cleaning, dressing and truing grinding wheels. With built-in shield and ergonomic handle. Wt. 0.3 lb.
009-25967 **9.99**

J. Craftsman Heavy-Duty Cast Iron Grinder/Buffer Stand. Multi-slotted cast iron top accommodates most grinders and buffers. Includes cast iron base and cooling pot. Measures 33 inches high. Wt. 60 lbs.
009-19210 **89.99**





Catalog/Online EXCLUSIVE
K. Craftsman 18-inch Laser-Guided Wet Tile Saw with Stand and Diamond Blade. Get precision cuts through ceramic, granite and even marble with this laser-guided water-cooled saw. Features a 1 hp, 6.7 amp motor that delivers 3,550 rpm cutting speed. Includes two 7-inch wet cutting diamond blade, water pump and adjustable rip guide. Warranted*.
 Wt. 89 lbs.
009-21541 299.99

L. Craftsman 7-inch Wet Tile Saw. Bench top wet saw with a 7-inch blade and 4.8 amps of power cut up to 1-inch-thick material. Table adjusts to 15, 30 and 45-degree tilt. Features stainless steel worktable with ribbed design and water collection system. Includes diamond blade, blade guard, rip fence, miter guide, wrench and manual. Wt. 17.05 lbs.
009-22320 99.99



includes two diamond blades

MK® DIAMOND—AN AMERICAN FAMILY TRADITION SINCE 1868

6-BLADE VALUE PACK



MORE MK BLADES ONLINE AT SEARS.COM/SHOPTOOLS

other value pack sizes at sears.com/shoptools

Catalog/Online EXCLUSIVES

M. MK® Wet/Dry 4-Inch Turbo Rim Diamond Blade Value Pack. For most masonry materials including brick, block, landscape, paver, fiber cement board, concrete, stucco, roof tile and asphalt. Wt. 1.80 lbs.
009-66590 49.99

N. NEW MK® Diamond TX-3 10-in. Wet Cutting Tile Saw. A unique misting system keeps dust down, allowing for indoor use. Features include a maintenance-free guide bar and fully adjustable tilting head for 22.5 and 45-degree miter cuts. Includes 10-in. diamond blade, water pump, rip guide, side table and folding stand with casters. Wt. 85 lbs.
009-90948 849.99

P. MK® 7-inch Tile Saw with Blade and Stand. Durable, lightweight, easily transported with offers of plenty of power. Chrome guide-bar and linear-bearing assembly ensures precise alignment/cutting. Features hinged blade guard, reinforced zinc-plated steel frame with carrying handles, MK-100 diamond blade, submersible water pump, adjustable rip guide and MK® Safeswitch. Wt. 30 lbs.
009-26728 399.99

Q. NEW MK® Diamond BX-4 14-in. Wet/Dry Cutting Masonry Saw. Lightweight and portable with a heavy-duty 1 3/4-hp direct drive motor, this saw features a removable plastic tray, locking table and a unique misting system to control dust. The adjustable depth stop prevents damage to table. Includes 14-in. dry cutting diamond blade. Wt. 70 lbs.
009-90949 799.99





includes 10" blade

A

B

ALL NEW

Catalog/Online EXCLUSIVE

A. NEW Felker Tile Master X3 Heavy-Duty Production Saw with Bonus Blade. Efficient 15-amp high torque 1 1/2 hp motor with 10-inch diamond saw cuts through a wide variety of materials with ease. Features plunge cut capacity, premium grade water pump, cast aluminum rip guide and guard and large conveyer cart. Wt. 127 lbs.
009-90830N ♦1,249.99

Catalog/Online EXCLUSIVE

B. NEW Tile Saw Stand. Sturdy, folding tile saw stand for use with X3 tile saw. Wt. 25 lbs.
009-90831129.99

Catalog/Online EXCLUSIVE

C. NEW Felker FTS-25 Portable Tile Saw. Lightweight design features 1/4 hp motor that powers the 4-inch diamond blade. Table supports up to a 12-inch tile. Includes blade, rip guide and variable angle guide. Wt. 9 lbs.
009-9082269.99

Catalog/Online EXCLUSIVE

D. NEW Felker FHS-4 Hand Saw with Case. Cuts through tile, stone, concrete, backer board and more, wet or dry. Features 4-inch diamond blade, safety switch and comfort grip handle. Angle cut up to 45 degrees. Includes blade, 8-foot water hose, hose connection and case. Wt. 13 lbs.
009-9082199.99

Catalog/Online EXCLUSIVE

E. NEW Felker FTS-50 Portable Tile Saw. 1/2 hp motor powers the 5-inch diamond blade with a table that supports up to a 12-inch tile. Tilting table features visible ruler guide and is hinged for 45-degree miter cuts. Includes blade, cutting guides and cover. Wt. 14 lbs.
009-90823109.99

Catalog/Online EXCLUSIVE

F. NEW Felker TM-75 Portable Tile Saw. 3/4 hp motor powers the 8-inch diamond blade for clean cuts through a wide variety of materials. Rigid textured cutting table features drainage grooves and metric and inch markings. Includes blade, four cutting guides, pump and wrenches. Wt. 42 lbs.
009-90826379.99

Catalog/Online EXCLUSIVE

G. NEW Folding Tile Saw Stand with Wheels. Optional folding stand with solid base for cutting tiles at standing level is equipped with wheels for easy mobility. For use with TM-75 Tile Saw. Wt. 44 lbs.
009-9082974.99

miter saw sold separately



oversized table

H

pneumatic wheels

J NEW

Catalog/Online EXCLUSIVE

H. Trojan Sawhorse Legs. Rugged, powdercoated steel legs. Comes in 27- or 35-inch heights. Clamp to any 2x4 cross-member in seconds. Gripping teeth hold securely for "wobble-free" stability, even on unlevel ground. Sold one horse per box. Folds for storage. Limited lifetime warranty*.
009-66587 27-inch. Wt. 13 lbs.59.99
009-22236 35-inch. Wt. 16 lbs.66.99

Catalog/Online EXCLUSIVE

J. NEW Trojan MS-2008-WB Wide-Body Miter Saw Stand. Unique "cart-to-stand" design is perfect for jobsite use as it rolls easily on 10" pneumatic wheels, even with your saw attached, then unfolds in seconds, creating a sturdy, 35" high table with 13 ft. of continuous work support and a huge 24" x 40" plywood table for unmatched saw mount and work surface area. With new flared legs and an 8" wider stance allows for safe, stable support of today's bigger saws. Rugged steel tube construction with powdercoat finish. Made in USA. Wt. 75 lbs
009-83047479.99

Also Available

Catalog/Online EXCLUSIVE

Trojan MS-2000 Miter Saw Stand. The same features as the MS-2008 with a 16" x 40" MDF table. Made in USA. Wt. 68 lbs.
009-18638399.99

K. Basic Stop for MS-2008-WB and MS-2000. For repetitive cuts up to 9 feet long. Wt. 3 lbs.
009-2909834.99

Also Available

Extension Wing for MS-2008-WB and MS-2000. With legs and rollers. Adds up to 30 inches in length for additional support. Wt. 15 lbs.
009-25294129.99

Catalog/Online EXCLUSIVE

L. NEW Trojan Portable Plan Table. Light, sturdy and easy to set up, this handy plan table attaches to any 2-inch stud to offer an instant 26 x 40-inch work surface. Features heavy-duty bracket powdercoated steel frame. Wt. 18 lbs.
009-83048129.99

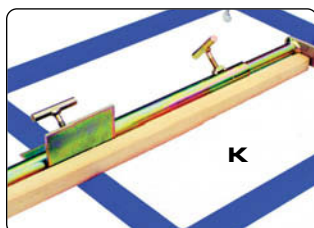

K

extra-wide stance

Felker® Tile Saw Blades

Item	Description/Size	Weight, lbs.	Price
TILE BLADES			
009-92810	4-in. x .060 x 7/8-5/8-in. FXC For 772478	0.3	\$12.99
009-92811	4 1/2-in. x .060 x 7/8-5/8-in. FXC For 772479	0.3	19.99
009-92813	5-in. x .060 x 7/8-5/8-in. FXC For 772480	0.5	24.99
009-92908	7-in. x .060 x 5/8-in. FXC For 772482	0.8	34.99
009-92910	8-in. x .060 x 5/8-in. FXC For 772483	1.0	39.99
009-93025	10-in. x .060 x 7/8-5/8-in. FXC For 772485	1.4	44.99
TURBO BLADES			
009-93026	4-in. x .080 x 7/8-5/8-in. FXT For 772497	0.3	\$12.99
009-93037	4 1/2-in. x .080 x 7/8-5/8-in. FXT For 772498	0.3	19.99
009-93042	5-in. x .080 x 7/8-5/8-in. FXT For 772499	0.5	24.99
009-93054	7-in. x .095 x 7/8-5/8-in. FXT For 772508	0.8	34.99
009-93055	8-in. x .095 x 7/8-5/8-in. FXT For 772509	1.0	39.99
009-93057	10-in. x 0.100 x 7/8-5/8-in. FXT For 772511	1.4	44.99
SEGMENTED BLADES			
009-93105	4-in. x .080 x 7/8-5/8-in. FXS For 772488	0.3	\$12.99
009-93120	4 1/2-in. x .080 x 7/8-5/8-in. FXS For 772489	0.3	19.99
009-93153	5-in. x .080 x 7/8-5/8-in. FXS For 772490	0.5	24.99
009-93154	7-in. x .095 x 7/8-5/8-in. FXS For 772491	0.8	34.99
009-93155	8-in. x .095 x 7/8-5/8-in. FXS For 772492	1.0	39.99
009-93156	10-in. x 0.100 x 7/8-5/8-in. FXS For 772494	1.4	44.99



BUY ONLINE
PICK-UP IN STORE!
 on eligible items



M. Port-A-Mate HTC3000 Professional Mobile Base. Provides portability for stationary power tools. Slotted side rails adjust to fit any stationary power tool from 14 x 14 in. to 38 x 38 in. Foot-operated floor locks and wheel locks secure the machine. 3-in. heavy-duty wheels, steel construction and 700 lbs. capacity. Wt. 19 lbs.
009-22308 99.99

Also Available
NEW Port-A-Mate PM1000 Universal Mobile Base. Wt. 15 lbs.
009-21271 49.99

N. NEW Rockwell® JawHorse™ Heavy-Duty Clamp Stand. Introducing a powerful portable workbench and clamping system. Features hands-free clamping jaws with more than 2,000 lbs. of gripping strength. Handles maximum work load of 600 lbs. Maximum clamping range is 37 in. Locking legs feature non-slip rubber feet. Measures 29" x 14" x 13" when folded and 39" x 39" x 34" when standing. Fold and roll for easy transport. Wt. 43 lbs.
009-89180 179.99

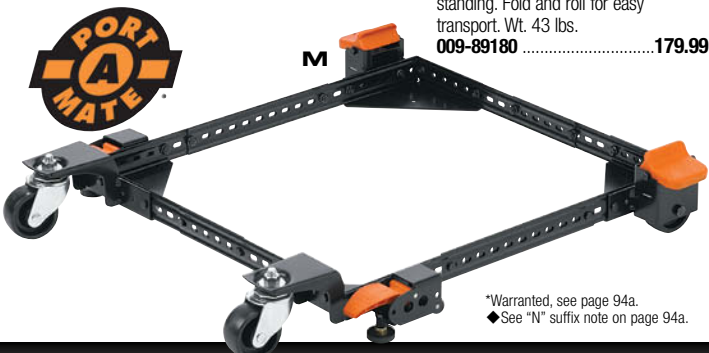

*Warranted, see page 94a.
 ♦See "N" suffix note on page 94a.

N NEW

Powerful clamping force—apply as much or as little clamping pressure as you require

Lock-release switch allows fast release of jaw

Foot-operated clamping frees up your hands for control of the job

Quickly folds down for storage and transport—rear leg acts as convenient carry handle

Front wheels make transport easy

Tripod base for all-terrain stability

Watch the online video featuring this lightweight jawhorse with 1-ton of hands-free clamping

ROCKWELL

CRAFTSMAN SPINDLE SANDER



A. NEW Craftsman Oscillating Spindle Sander. Sand contours, arcs, and curves faster and easier on this extra-large 18-inch cast iron worktable. Powerful 1/4-hp motor delivers 1,725 rpm and 30 1-inch spm to prevent chatter and burn marks on wood. Drives sanding drums from 1/2 to 3-inch dia. Features built-in dust collection, rubber foot pads, on-board storage and locking paddle switch. Includes six abrasive sleeves and five abrasive drums. Imported. Wt. 5.06 lbs.

009-21500 279.99

B. Craftsman 6-inch Bench Top Buffer. For buffing and polishing wood, plastics, brass, copper, metals, rocks, jewelry. Powerful 120 volt 1/2 hp motor for continuous duty operation at up to 3,450 rpm. Includes 6-in. spiral and soft cotton buffing wheels. Extra long shaft. Wt. 20 lbs.

009-22625 99.99

C. Craftsman 8-inch Bench Top Buffer. Powerful 115 volt motor develops maximum 1-1/2 hp and 3,450 rpm for buffing and polishing. With lock-on power button and single speed capability. 5/8 in. shaft with 3-1/2 cast iron flange. Wt. 38 lbs.

009-21181 149.99

D. Craftsman Professional 6 x 48-inch Oscillating Belt and 12-inch Disc Sander. This versatile sander features a heavy-duty, one-piece body, adjustable table tilt for angled work and easy-to-use belt tension controls. 4-inch dust collection ports on belt and disc. Includes sandpaper and miter gauge. 1 1/2 hp. 15 amps. Belt size is 6 x 48 in. and has a speed of 1,570 fpm. 12-inch disc size with a speed of 2,000 rpm. Wt. 214 lbs.

009-22606 759.99

E. Craftsman 4 x 36-inch Belt and 6-inch Disc Sander. Features miter gauge, 45 degree tilting cast aluminum worktable, dust collection port, easy-to-use belt tension controls. Easy tracking of sanding belt with thumb wheel. 1/3 hp. 3.4 amps. Belt size is 4 x 36 in. with a speed of 1,100 fpm. The disc size is 6 in. and has a speed of 2,200 rpm. It has a table quantity of one and the material is AL. Wt. 47 lbs.

009-21514 129.99

F. Craftsman 6 x 48-inch Belt and 9-inch Disc Sander with Built-in Dust Collector. Belt sander provides over 100 sq. in. of sanding surface. Dust collection keeps work area clear of debris. Includes universal cast iron table and miter gauge. 3/4 hp. 8 amps. Belt size is 6 x 48 in. with a speed of 2,400 fpm. The disc size is 9 in. and has a speed of 3,100 rpm. It has a table quantity of one and the material is Cl. Wt. 105 lbs.

009-21757N ♦ 249.99

G. Craftsman 2 x 42-inch Belt and 6-inch Disc Sander for Contour Sanding. Belt arm operates vertically and horizontally. Table tilts to 45 degrees. Removable platen for contour sanding. Built-in dust collection port on disc table. 1/3 hp. 5 amps. Belt size is 4 x 36 in. and has a speed of 1,100 fpm. 8-inch disc size with a speed of 2,200 rpm. It has a table quantity of two and the material is AL. Wt. 37 lbs.

009-21513 139.99

FIND SANDING BELTS, DISCS AND ACCESSORIES AT SEARS.COM/SHOPTOOLS



6 x 48 IN. BELT/12-IN. DISC



6-INCH

8-INCH



6 x 48 IN. BELT/9-IN. DISC



4 x 36 IN. BELT/6-IN. DISC

2 x 42 IN. BELT/6-IN. DISC



CRAFTSMAN®

H. Craftsman 4-inch Hose Extension Kit. Extend or replace original hose on any single-stage or two-stage dust collector and fume exhauster. Kit includes 4-inch diameter by 5-foot-long wire reinforced PVC hose inlet, 2 clamps and sheet metal connector sleeve. Imported. Wt. 6 lbs.
009-2139749.99

J. Craftsman Professional 1 1/2-hp Dust Collector. This professional dust collector will keep your work area clean and dust-free with a powerful 1 1/2 hp, 115/230-volt motor designed for smooth, long-lasting operation. 1,200 cfm is powerful enough to use with multiple machines. 30-micron bag ensures dust collection. Ideal as the foundation for a central dust collection system, unit easily handles any two shop machines simultaneously. Sturdy casters make this unit highly mobile. Includes 5-foot ribbed, flexible hose with a 4-inch diameter opening. Warranted*. Wt. 108 lbs.
009-21337389.99

K. Craftsman 1/2-hp Portable Dust Collector. This dust collector has a wide dust hood for easy hookup to a variety of woodworking machines. The curved steel impeller moves chips and dust, while the 30-micron bag efficiently collects debris. 600 cfm rating, 3/4 hp, 115-volt motor. Weighs just 39 pounds and fits easily under table saw extension wings. Rubber feet minimize vibration. Use for light-duty planing, jointing and shaping jobs. CSA approved. Wt. 46 lbs.
009-21335219.99



Catalog/Online EXCLUSIVE
L. NEW Craftsman Mini Dust Collector. Truly portable and lightweight at only 0.8 lbs.! 4-in. diameter intake port for easy hook-up to any shop machine, including portable planers. 300 cfm delivers plenty of power. Includes 30-micron dust bag. Wt. 6.5 lbs.
009-2139399.99

M. Craftsman Two-Stage Dust Collector. This two-stage dust collector allows chips and heavier particles to drop to the bottom of the drum (available separately 009-21396) while lighter particles are captured in the dust filter bag which extends life of impeller and housing and allows easy removal of collected particles. 7 inches of H₂O max. static pressure. 3/4 hp, 115/230 VAC motor, 9.4/4.7 amps, 5,500 fpm, 600 cfm. Imported. Warranted*. Wt. 55 lbs.
009-21395579.99

N. Craftsman 30-Gallon Drum. 30-gallon collapsible drum for use with 009-21395 two-stage dust collector. 30 gallon wet/25.8 gallon dry capacity (for dry applications only). Steel construction with casters. Imported. Warranted*. Wt. 30 lbs.
009-2139674.99

SEARS.COM/SHOPTOOLS
 Sign up to be notified when items go on sale.



L NEW



DUST COLLECTION SYSTEM ACCESSORIES



P. Dust Collection Grounding Kit. 50 feet of braided 14-gauge copper wire, two grounding screws, two terminal ends, six wire nuts and one drill bit. Wt. 0.77 lb.
009-2133924.99



Catalog/Online EXCLUSIVE
Q. Dust Collection Starter Kit. Has one 4 in. x 10 ft. plastic ribbed hose, one universal dust hood, six 4 in. hose clamps, two 4 in. "Y" fittings, two 4 in. 90-degree elbows and two 4 in. plastic blast gates. Wt. 12 lbs.
009-2138879.99



Catalog/Online EXCLUSIVE
R. Deluxe Dust Collection Kit. Has two schedule 20 pipe-to-flex hose connectors, two schedule 20 pipe-to-dust connector fittings, one universal dust hood, two 4 in. x 10 ft. plastic ribbed hose, four 4 in. hose clamps, two 4 in. "Y" fittings and four 4 in. plastic blast gates. Wt. 21 lbs.
009-21389129.99

For more photographs and additional product specifications, simply enter the catalog number at sears.com/shoptools.

*Warranted, see page 94a.
 ♦ See "N" suffix note on page 94a.

FOR CLEAN-UP NEEDS – LARGE OR SMALL



Catalog/Online EXCLUSIVE

A. NEW Craftsman Wet/Dry Vac Advanced Cleaning System™. This all-in-one cleaning system features organized drawer storage for accessories and hose, and a slide-out drum for quick and easy emptying. Includes fine dust filter, locking pro hose, collapsible handle and 20-foot power cord. Large, lockable rear wheels. Wt. 53 lbs.

009-17789.....199.99



Craftsman Wet/Dry Vacs

Key	Catalog Number	Description, Details, Features	Capacity, gallons	Peak HP	Shipping Weight, lbs.	Price
B.	009-17762	Tackle tough jobs with the largest capacity Craftsman wet/dry vac. Large drain to easily empty contents of drum, POS-I-LOCK™ hose and 8 accessories.	20	6.5	32	109.99
C.	009-17761	Portable, large capacity wet/dry vac great for big jobs. Includes large drain to easily empty drum contents and 20-ft. long power cord.	16	6.0	26.6	99.99
D.	009-17765	This mid-sized, portable wet/dry vac cleans up after large jobs. Features oversized on/off switch, accessory storage and drain to easily empty drum contents.	12	5.0	27	79.99
E.	009-17776	Multi-use portable wet/dry vac is great for indoor use and car clean-up. Features convenient hose and accessory storage. Wheels and casters allow easy mobility over different floor surfaces.	4	5.0	17	69.99
F.	009-17925	Wall mounted and compact wet/dry vac. Fold and carry handle makes this vac highly portable and helps eliminate clutter on the floor.	5	5.0	25	99.99
G.	009-17713	Powerful and portable compact wet/dry vac includes 4-foot hose and 3 accessories.	2	1.5	7.8	29.99
H.	009-17066	Specialty series wet/dry vac with 265 mph detachable blower. Includes accessory storage.	16	6.5	32	119.99

J. NEW Craftsman 16 Gallon 2-Stage Industrial Wet/Dry Vac. Quieter than traditional wet/dry vacs, this heavy-duty unit features dual stage motor for a deeper cleaning. Offers large built-in drain, removable storage bag and cart for easy maneuverability. Wt. 40.1 lbs.
009-17915 **349.99**

Also Available
NEW Craftsman 14 Gallon 2-Stage Industrial Wet/Dry Vac. Wt. 37.7 lbs.
009-17910 **299.99**

K. NEW Craftsman Professional 16 Gallon Stainless Wet/Dry Vac. Durable stainless steel construction with a 6.5 peak hp motor. Includes fine dust filter, large rear wheels, collapsible cart handle, nylon storage bag and flexible pro hose. Wt. 38.8 lbs.
009-17778 **199.99**

L. NEW Craftsman Heavy-Duty Vac Kit. Kit includes metal extension wands, dusting brush, claw nozzle, crevice tool, 1 7/8-inch wand and 1 7/8 to 2 1/2-inch adapter. Versatile nozzle with 3 inserts – squeegee, carpet and brush. Wt. 5.52 lbs.
009-17833 **49.99**



Wow, our new 16 gallon 2-stage vac is quieter and has a dual stage motor for added power!

TONY'S PICK



COMPLETE ASSORTMENT OF VACUUM ACCESSORIES AT SEARS.COM/SHOPTOOLS



nylon accessory storage bag

K NEW
 6.5 peak hp



L NEW

Craftsman Wet/Dry Vac Filters and Accessories

Item/Catalog Number	Description	Details, Features	Weight, lbs.	Price
009-17816	Craftsman Red Stripe Replacement Filter	For use with 5-gallon wall vac, 6-gallon vacs made since 1992 and 8, 9, 11, 12, 14, 16, 20, 32 gallon vacs made since 1988 (excluding Craftsman Professional vacs and 009-17920, 009-17921, 009-17922, 009-17923, 009-17932, 009-17935, 009-17937). Measures 8H x 6 1/2W in.	1.00	\$16.99
009-17907	Craftsman Fine Dust Filter	Microban® treated pleated filter, for use with 5-gallon wall vac, 6-gallon vacs made since 1992 and 8, 9, 11, 12, 14, 16, 20, 32 gallon vacs made since 1988 (excluding Craftsman Professional vacs and 009-17920, 009-17921, 009-17922, 009-17923, 009-17932, 009-17935, 009-17937). Measures 8H x 6 1/2W in.	1.00	22.99
009-17912	Microban® HEPA Rated Filter Material	99.97 percent efficient at removing particles as small as 0.3 microns. For use with 5-gallon wall vac, 6-gallon vacs made since 1992 and 8, 9, 11, 12, 14, 16, 20, 32 gallon vacs made since 1988 (excluding Craftsman Professional vacs and 009-17920, 009-17921, 009-17922, 009-17923, 009-17932, 009-17935, 009-17937). 8H x 6 1/2W in.	1.00	29.99
009-16950	Microban® HEPA Filter Material (half height)	99.97 percent efficient at removing particles as small as 0.3 microns. For use with 3 and 4-gallon wet/dry vacs. Measures 4H x 6 1/2W in.	0.56	24.99
009-16954	Craftsman High-Efficiency Bags for 12-gallon Vacs	Dry pick-up only. For dust and non-hazardous, non-toxic, non-flammable fine particles and drywall dust. Fits Craftsman 12-gallon wet/dry vacs, 009-17765. Two included.	0.15	12.99
009-17896	Craftsman Drywall High-Efficiency Bags	Dry pick-up only. For dust and non-hazardous, non-toxic, non-flammable fine particles and drywall dust. Fits Craftsman wet/dry vacs, 009-17761, 009-17762, 009-17066, 009-17784. Two included.	1.00	14.99
009-17895	Craftsman Filter Bags	Dry pick-up only. For dust and non-hazardous, non-toxic, non-flammable fine particles and drywall dust. Fits Craftsman wet/dry vacs, 009-17761, 009-17762, 009-17066, 009-17784. Three included.	1.00	11.99
009-17812	Craftsman Blue Stripe Replacement Filter	For 009-17780, 009-17800, 009-17810, 009-17845, 009-17908, 009-17979, 009-17983, 009-17984, 009-17986. Measures 8 1/4H x 6 1/4W in.	0.70	16.99
009-17804	Craftsman Green Stripe Replacement Filter	For 009-1782, 009-1786, 009-17877, 009-17904, 009-1796, 009-1797, 009-1798, 009-17988, 009-17922, 009-17923 and 009-17925. Measures 10 1/4H x 9W in.	2.10	16.99
009-17810	Craftsman Purple Stripe Filter	For 009-17776, 009-17726 and 3-gallon vacs. Measures 4H x 7W in.	0.70	12.99
009-17809	Craftsman Orange Stripe Replacement Filter	For 009-17802, 009-17851, 009-17855, 009-1787, 009-1788, 009-1792, 009-1793 and 009-17931. Measures 8 1/4H x 7 1/4W in.	1.40	16.99

*Warranted, see page 94.

WORKSHOP SOLUTIONS

INTRODUCING—HEPA VACS THAT THE PROS USE!

SOLVE A MYSTERY OR CLEAN UNUSUAL SNUG PLACES. . . LIMITLESS USAGE



A THE BLACK OMEGA. . . QUIET POWER!

accessories for both models, tuck away neatly inside top lid

B

THE GREEN MACHINE. . . SUPREME POWER!

ALL NEW

BUY ONLINE
PICK-UP IN STORE!
on eligible items

PIRANHA
by Tornado



Catalog/Online EXCLUSIVE
A. NEW Atrix® Omega™ Supreme Portable Vacuum. Quiet 1 hp Flow-thru motor with sound baffles and electronic line filter, self-storing utensils (cover insert), crevice tool with brush, 16" rubber flex-neck tool, detachable power cord and shoulder strap with D-rings. Sold with HEPA disposable filter canister. Fully statically controlled. Model VACOMEGASLFH. Warranted*. Wt. 14 lbs.

009-82730 299.99



Catalog/Online EXCLUSIVE
B. NEW Atrix® Green Supreme Portable Vacuum. Quiet 1 hp Flow-thru motor with sound baffles, self-storing utensils (cover insert), 6' ESD safe hose, ESD crevice tool, 16" ESD gooseneck, two 20" wands, utility nozzle with brush, shoulder strap with D-rings, HEPA filter and 25' power cord. Fully statically controlled. Model VACGRNS. Warranted*. Wt. 14 lbs.

009-82731 349.99



GREAT ASSORTMENT OF VACUUM ACCESSORIES AT SEARS.COM/SHOPTOOLS



D

PORTABLE SUCTION POWER!



backpack functionality



accessories

Catalog/Online EXCLUSIVE
C. NEW Piranha 15-Gallon Wet/Dry Vac with Tools & Squeegee. Tough, versatile, and cost-effective, with a 1.61 hp vac motor that generates 114 cfm and 90" of waterlift to effectively handle general dry debris in commercial environments, as well as water, scrubbing and stripping solutions. Perfect for general maintenance and cleaning, and mopping and scrubbing operations as well. Warranted*. Wt. 60 lbs.

009-82976 449.99

D. NEW Piranha 1/2-hp, 3-speed Blower Fan. This durable, rotationally-molded blower is perfect for drying wet floors or after fire, flood, or other water damage. Airflow may be directed at three angles (0, 30, and 90-degrees), and the unit is stackable for easy storage. Warranted*. Wt. 30 lbs.

009-82989 229.99

E. NEW Piranha Back Pack Vacuum. A faster and more cost-effective alternative to traditional upright vacuums. Designed for comfort and productivity, these super-quiet units eliminate the need to bend over. As a result, cleaning productivity dramatically increases to over 7,000 square feet per hour. Warranted*. Wt. 11 lbs.

009-82977 319.99



C



E

F. NEW Tuff-Chix™ Paige Hemmis Tool Belt Pouch. The same belt worn by Paige Hemmis on Extreme Makeover Home Edition. Features canvas upper and straps with clasp, two back pockets and silver studs. Wt. 0.4 lb.
009-87685 **39.99**

G. NEW Tuff-Chix™ Paige Hemmis Workgloves. Double women's landscapers work gloves designed by Paige Hemmis of Extreme Makeover Home Edition. Washable synthetic leather. Wt. 0.2 lb.
009-48064 MED **17.99**
009-48065 LRG **17.99**
009-48066 XLG **17.99**

H. NEW The Original Pink Box™ Homeowners Tool Set. All the basics to tackle projects in your home, apartment or dorm room. Set includes 16-foot tape measure, claw hammer, adjustable wrench, needle-nose pliers, standard pliers, slotted and Phillips screwdrivers and mini 7-piece screwdriver set. Wt. 4.2 lbs.
009-87684 **49.99**

J. NEW The Original Pink Box™ Homeowners Tool Bag. This heavy-duty tool bag is a smart way to store personal items as well as tools. Features 26 inside/outside pockets, metal clip to hold a tape measure, heavy-duty zipper and strong, comfortable handles. 12" x 9" x 9". Wt. 1 lb.
009-87901 **19.99**

K. NEW The Original Pink Box™ Multi-use Chest. Pink powdercoated two-drawer tool box features ball bearing slides, pink drawer liners and a coded round lock with pink key. Great for makeup, jewelry, and of course tools! 18" x 10" x 11 1/2". Wt. 26 lbs.
009-87900 **89.99**

THE ORIGINAL
PINK BOX



ALL NEW

L. Digital Worktunes with Hearing Protection. Enjoy the perfect union of a sound system with hearing protection. Features AM/FM stereo, MP3 input jack, digital tuning, preset stations and LCD screen. Wt. 1.22 lbs.
009-66541 **49.99**

Catalog/Online EXCLUSIVE M & N. AOSafety® Hard Hats. Engineered for safety, comfort and durability these top-quality hats are available with adjustable pin-lock or ratchet suspensions and have accessory slots for hearing and face protection. High-gloss, bold designs on a tough, dual layer shell feature easy ratchet size adjustment, 4-point, adjustable nylon suspension and a large, pillow-padded sweatband. Non-conducting hats meet ANSI Z89.1, Class C, E and G. Warranted*. Wt. 2 lbs.
M. Real Flame.
009-66542 **24.99**
N. NEW Patriot.
009-82968 **24.99**

P. Force 3™ Safety Glasses with Interchangeable Lenses. Rugged performance meets distinctive style with 99.9% UV A & B protection. Meets ANSI Z89.1 safety standards and OSHA-compliant. Includes gray, red and indoor/outdoor gasket lenses. Also comes with frame, lanyard and storage bag. Wt. 0.58 lb.
009-66544 **39.99**

Catalog/Online EXCLUSIVE Q. NEW AO Safety® ForceFlex® Glasses. A powerful combination of strength, comfort and performance, ForceFlex® features a lens-to-frame binding technology that dramatically increases impact ratings and resilience. Amazingly flexible frames with soft rubber accents adjust for a perfect fit. Offers 99.9 percent UV ray protection. Wt. 0.5 lb.
009-89591 **15.99**

Catalog/Online EXCLUSIVE R. NEW AO Safety® Blockade® Noise-Isolating Ear Buds. iPods and MP3 Player-compatible. Radically reduce external noise in your work area with these ultra-comfortable earbuds, with a triple flange design that holds them comfortably in place while blocking noise. Features integrated volume control. Wt. 0.25 lb.
009-89593 **39.99**

Catalog/Online EXCLUSIVE S. NEW AO Safety® G1 Hand and Eye Protection Kit with Earplugs. Set includes X-Factor with indoor/outdoor impact-resistant lenses that offer 99.9 percent UV protection. Performance Work Gloves feature anti-slip traction on palm and fingertips, neoprene cuff with Velcro® closure. Includes reusable earplugs. Wt. 0.65 lb.
009-89595 **24.99**



*Warranted, see page 94a.

Catalog/Online EXCLUSIVE

A and B. Earlex® Spray Stations.

The modern way to spray and use HVLP (high volume, low pressure) technology to ensure a great finish, minimal overspray and make your paint go further. Easy to use, these Spray Stations are ideal for large or small indoor and outdoor projects and can be used with a wide variety of oil- and water-based coatings such as latex (thinned), stains, polyurethanes, varnishes, lacquers and more.

A NEW Earlex® HV3000 HVLP Spray Station.

Ideal for homeowners (or DIY'ers) and first-time woodworkers. Includes a brass latex and a fine finish tip, extra quart pot, viscosity cup and 8-foot hose. 6" spray width. Onboard storage. Wt. 10.8 lbs.

009-89207 139.99

B. Earlex® HV5000 HVLP Spray Station.

Perfect for pro-users or serious woodworkers. Includes a professional spray gun with a stainless steel latex and a fine finish tip, Teflon-coated pot, push 'n' click pattern changing, up to 12" spray width. 13-foot hose and gun cleaning kit. Onboard storage. Wt. 13 lbs.

009-16460 299.99



A NEW



Catalog/Online EXCLUSIVE

C. Evolution Twister 1100 Variable-Speed Mixer with Multipurpose Paddle.

A high-quality mixer with variable speed control from 250-750 rpm. Features a robust headstock and ergonomic handle for maximum comfort and control. Includes multi-purpose paddle and wrench. Warranted*. Wt. 15 lbs.

009-61254 149.99

Catalog/Online EXCLUSIVE

F. Wagner Texture Sprayer.

The built-in air turbine provides power to spray texture to a large area and is simple enough to make it perfect for small touch-up jobs. Plug into a standard 15 amp wall socket and spray. Uses the same material the pros use to achieve the look you want. Setup and cleanup are fast and easy with no tools required. One-gallon, two-position hopper can be configured for spraying walls or ceilings without the use of adapters. Wt. 6.4 lbs.

030-15620 99.99

Catalog/Online EXCLUSIVE

G. Wagner Paint Eater.

Aggressive on paint, this gentle tool delivers professional results with speed and ease. Features soft grip cover, Velcro strap, arbor lock and shroud to protect hand. Wt. 4.5 lbs.

030-15544 79.99

Also Available

Paint Eater Replacement Disc. Wt. 0.4 lb.

030-15545 14.99

Catalog/Online EXCLUSIVE

H. Wagner Airless Piston Pump Paint Sprayers.

High-performance airless spray system for residential and light commercial applications. Powerful DC motor coupled with Wagner's Twin Stroke Piston provides the performance required for a wide variety of applications. Piston Pumps are great for high-end do-it-yourselfer, handyman, painting contractors and other contractors who want to paint faster than traditional methods. Perfect for larger surface projects; wood siding, wood fences, metal and stucco. Uses latex, oil-based, stain, varnish and sealers. Wt. 53.0 lbs.

030-20058 599.99

More Wagner airless sprayers in chart below.

Catalog/Online EXCLUSIVE

J. Wagner Airless Sprayer Hose. 50' x 1/4" flexible paint hose for Wagner models 9145, 9155, 9175 and 9195 airless sprayers. 3,000 psi max. Also fits Graco and Campbell Hausfeld airless sprayers. Wt. 4.02 lbs.

030-20060 54.99

*Warranted, see page 94a.

WAGNER PROFESSIONAL PAINTING PRODUCTS

Contractor tested and engineered for the rigors of everyday use. Wagner Airless Paint Sprayers feature double stroke piston pumps, able to run at slower speeds, keeping wear to a minimum and delivering material flow and pressures for a wide variety of coatings, making them the choice of professionals. Airless spray systems offer these benefits to the professional and advanced home user:

- High transfer efficiency
- Fast application with excellent coverage
- Excellent coverage on irregular surfaces
- Less bounceback



acoustical popcorn

knock down

orange peel

Wagner Twin Stroke Airless Sprayers									
Description	Item Number	Gal./Min.	Max. PSI	HP	Max. Tip	Ship Wt.	Includes	Price	
9145 Airless Paint sprayer	030-20056	0.25	2800	0.50	0.015	26 lbs.	Hose/GX5 gun/tip	\$349.99	
9155 Airless Paint sprayer	030-20057	0.29	3000	0.63	0.017	32 lbs.	Hose/GX5 gun/tip	449.99	
H. 9175 Airless Paint sprayer	030-20058	0.33	3000	0.75	0.019	35 lbs.	Hose/GX5 gun/tip	599.99	
9195 Airless Paint sprayer	030-20059	0.42	3000	0.88	0.021	37 lbs.	Hose/GX5 gun/tip	649.99	

K NEW



Catalog/Online EXCLUSIVE
K. NEW Xtend & Climb® Stepladder. Get flexibility and convenience with this telescoping stepladder that extends and locks by the foot. Opens from 27 inches to 7 1/2 feet. Features carrying handle and can hold up to 300 lbs. Wt. 31 lbs.
009-89603..... 299.99



Xtend & Climb
 folds for easy transport

N NEW



opens to 8 1/2 feet

M

opens to 12 1/2 feet

Catalog/Online EXCLUSIVE
L. Xtend & Climb® 750P Type II Home Edition Ladder. Built for heavy-duty use in home and building maintenance, this sturdy ladder locks at each foot and opens and closes with ease. Type II ANSI rated to 225 lbs. Opens to 8 1/2 feet, closes to 27 inches. Features non-slip end caps, carrying handle and closure strap. Wt. 20 lbs.
009-90692..... 119.99

Also Available
Xtend & Climb® 785P Type I Professional Shop Ladder. Versatile and super-strong, this industrial ladder is ideal for commercial and contractor settings. Opens and closes with ease, locking by the foot. Type I ANSI rated to 250 lbs. Opens to 15 1/2 feet, closes to 35 inches. Features non-slip end caps, carrying handle and closure strap. Wt. 38 lbs.
009-90693..... 269.99

P NEW



Check online for **SALE PRICING!**

includes storage and accessories



Catalog/Online EXCLUSIVE
M. Xtend & Climb® 770 Home and Shop Ladder. Perfect for home, shop and worksite. Type II ANSI rated to 225 lbs. Opens to 12 1/2 feet, closes to 30 inches. Features angled thumb release, non-slip end caps, carrying handle and closure strap. Warranted*. Wt. 28 lbs.
009-43358..... 179.99

Catalog/Online EXCLUSIVE
N. NEW UP*UP™ Lightweight Step Stool. Extremely light and portable, this sturdy household step stool is crafted in aluminum. Compact for easy storage. Wt. 5.2 lbs.
009-89597..... 49.99

Also Available
Xtend & Climb® 780P Home and Shop Ladder. Built for heavy-duty use in commercial and contractor settings, this industrial-strength ladder is super strong. Type 1A ANSI rated to 300 lbs. Opens to 12 1/2 feet, closes to 30 inches. Features angled thumb release, non-slip end caps, carrying handle and closure strap. Warranted*. Wt. 36 lbs.
009-43360..... 249.99

Catalog/Online EXCLUSIVE
P. NEW IMAC® Mini Scaffolding. Versatile and compact, this lightweight multi-level mini scaffolding can hold up to 600 lbs. Wt. 40 lbs.
009-89601..... 169.99

Catalog/Online EXCLUSIVE
Q. Professional Roofing Fall Protection Kit. Ideal for roofing applications, this kit comes complete with harness, 3-inch low profile lanyard, 25-foot lifeline with rope grab, reusable roof anchor and storage bucket. Meets ANSI and OSHA guidelines. Wt. 30 lbs.
009-66540..... 169.99



R
 36 inch

Catalog/Online EXCLUSIVE
Blue Blower Drum Fans. Built for industrial performance, these heavy-duty fans are constructed with 12-gauge steel and motor mount bars for strength and stability. Fans feature 1/3-hp motor, wheel cart with ball-bearing wheels. OSHA compliant.

R. PB36A 36-inch Drum Fan. Delivers up to 12,900 cfm airflow. Features two-speed control. Wt. 96 lbs.
009-74950..... 299.99



S

Also Available
PB24T 24-inch Drum Fan. Delivers up to 8,000 cfm airflow. Features three-speed control. Includes ceiling mount. Wt. 54 lbs.
009-74951..... 199.99

Catalog/Online EXCLUSIVE
S. Blue Blower PB4000 3-Speed Professional Grade Blower. High-velocity motor moves air at 2,900 to 4,000 cfm. Heavy-duty 30-foot cord and built-in handle. Wt. 40 lbs.
009-90909..... 299.99



T



Also Available
Blue Blower PB2500 3-Speed Commercial Grade Blower. Turbine 1/2-hp motor moves air at 2,500 cfm. Heavy-duty 30-foot cord and built-in handle. Wt. 36 lbs.
009-90911..... 249.99



U

Catalog/Online EXCLUSIVE
T. Blue Blower BB3000i 3-Speed Professional Air Mover. Commercial-quality powerful, portable 8-lb. air-moving machine produces 300 cu. ft. per min. of cooling air for areas up to 30 feet away. Compact and quiet, it features built-in handles and two built-in 15-amp grounded receptacles for power tools. Wt. 9 lbs.
009-90910..... 79.99

U. Blue Blower BB1907i Accessory Heater. This 5,300 BTU heater quickly converts your Blue Blower into a lightweight, portable heater. Ideal for personal comfort and drying applications. Features lighted on/off switch and automatic over-temperature shut-off switch. Wt. 3 lbs.
009-90908..... 39.99

INTRODUCING FEIN® POWER TOOLS

ELECTRIC POWER TOOLS FOR PROFESSIONALS

ALL NEW



SEE MORE FEIN SANDER ACCESSORIES AT SEARS.COM/SHOPTOOLS



Catalog/Online EXCLUSIVE

A. NEW Fein® MultiMaster Tool Kit. Powerful 250-watt motor with electronic variable speed control oscillates head in an arc of 3.2 degrees at a rate of 14,000-21,000 opms to cut metals as well as wood. Features a new tool-free quick-release blade mechanism to change a broad range of accessories for nearly limitless applications. Tool mounting is star-shaped to prevent the blade from creeping when cutting. Includes sanding sheets (80, 120 and 180 grain), universal E-CUT blade, HSS segment blade, carbide-tipped segment blade, rigid stopping knife, profile sanding set, dust extraction device, perforated sanding pad, carbide rasp and case. Wt. 11.5 lbs.
009-88431 399.99



Catalog/Online EXCLUSIVE

B. NEW Fein® Mag Drill. Compact construction and light weight make this drill very easy to handle. Infinitely variable stroke range setting for fast and keyless tool changes. Robust and accurate dual dove-tail guide. Electronic overload cut-out if the drilling pressure is too high for protection of motor and tool. MagnetMonitorSystem guarantees long service life of the magnetic coils. Integral cooling lubricant for clean cutting and long tool life. Wt. 36.2 lbs.
009-88435 1,299.99

Catalog/Online EXCLUSIVE

C. NEW Fein® 8-inch Dust-Free Random Orbit Sander. A true advancement in sanding technology, this tool features a 98-percent effective dust extraction system for cleaner operation and a more even finish. "True" orbit design features orbiting motion created by ball bearings mounted on weighted eccentric shaft. Delivers 900 to 7,000 rpm and a 5/16 stroke. Adapts for left or right hand operation. Wt. 7.75 lbs.
009-82755 879.99

Catalog/Online EXCLUSIVE

D. NEW Fein® 6-inch Random Orbit Sander. Wt. 3.7 lbs.
009-82756 499.99

Catalog/Online EXCLUSIVE

E. NEW Fein® Turbo III 14.5-Gallon Auto-Start Dust-Free Wet/Dry Vac. One of the quietest vacs on the market, this powerful unit is designed for continuous industrial use. Features a two-stage motor and a 14.5 gallon dry and 12 gallon wet capacity. Just plug tool into mounted outlet and the automatic on/off switch activates vac when tool is turned on. Filter upgrades and accessories available. Includes 16-foot cord, 10-foot 2 1/4-inch hose, hose adapter and 5-micron cloth filter. Wt. 36 lbs.
009-82752 479.99

Also Available

Fein® Turbo I 6-Gallon Auto-Start Dust-Free Wet/Dry Vac. Features 6 gallon dry and 5.3 gallon wet capacity. Includes brush, crevice tool, 16-foot cord, 16-foot 2 1/4-inch hose, hose adapter and 5-micron cloth filter. Wt. 17.75 lbs.
009-82750 329.99

Fein® Turbo II 9-Gallon Auto-Start Dust-Free Wet/Dry Vac. Features 9 gallon dry and 6.8 gallon wet capacity. Includes brush, crevice tool, 16-foot cord, 16-foot 2 1/4-inch hose, hose adapter and 5-micron cloth filter. Wt. 28.6 lbs.
009-82751 399.99



CRAFTSMAN®

F. NEW Craftsman Professional 2.7-amp 5-inch Vibrafree® Random Orbit Sander with Cyclonic Dust/Air Separator. Delivers 12,000 opm. New vibrafree™ technology reduces tool vibration by over 67% when compared to Craftsman sander #27673. Features efficient Cyclonic Dust Collection system, lightweight aluminum base, sealed switch and over-mold handle. Includes sander, dust box, 1 1/4 to 2 1/2-inch dust tube adapter, 5 pieces each of fine, medium and coarse sandpaper, and case. Wt. 8.6 lbs. **009-25927.....99.99**

Catalog/Online EXCLUSIVE
G. Craftsman Professional 1/4-inch 2.4-amp Pad Sander. Single speed motor delivers

14,000 opm for fast and smooth material removal. Featuring an overmold handle, 100 percent ball bearing construction, dust bag, paper punch, 2 pieces of sandpaper and case. Wt. 9.4 lbs. **009-27670.....49.99**

Catalog/Online EXCLUSIVE

H. NEW Craftsman 6-amp 3 x 18-inch Belt Sander with Filtered Dust Collection System and Belts. Ergonomically designed handles reduce vibration and enhance comfort. Delivers 700 rpm and 1,000 sfpm. Hard shell dust collection system is easy to remove and empty, and allows for a wet/dry vac attachment. Features a live-tool indicator and includes a six-belt assortment: 2 fine, 2 medium and 2 rough belts. Wt. 9.8 lbs. **009-79573.....69.99**

J. Craftsman 6-inch Sander/Polisher with Rear Twist Handle. This versatile two-speed (1,400 and 1,600 rpm) sander/polisher with a 4.5-amp motor is great for most sanding or polishing tasks. Rear handle rotates 90 degrees left or right. Auxiliary handle mounts on the top, right or left sides. Spindle lock makes it easy to remove or install the rubber pad, live tool indicator glows green when tool is plugged in. Includes rubber backing pad, polishing bonnet, wrench, spanner nut and auxiliary handle. Wt. 6.1 lbs. **009-11506.....89.99**

Catalog/Online EXCLUSIVE

K. Craftsman Mouse Sander. Compact design for performance in those hard to reach areas. Saddle cushioned grip for optimal comfort and control. 0.5 amps for optimal tool performance. Kit includes 34 accessories. Finger detail attachment allows for getting into tight areas. Wt. 3 lbs. **009-11683.....39.99**

L. Craftsman 10-inch Buffer/Polisher. Pamper your vehicles with this quality buffer/polisher. Designed for ease of use and comfort, unit delivers 2,800 random orbits per minute. Comes with three applicator bonnets, a polishing bonnet, hand applicator, three terrycloth bonnets and a 5-gallon bucket. Warranted.* Wt. 9 lbs. **009-10723.....54.99**

Our pro sander reduces vibration and user fatigue and the dust collector reduces the mess.

TONY'S PICK



F NEW

active cancelling technology
vibrafree™
12,000 opm



includes
6 sanding
belts

H NEW

MORE TO EXPLORE
at sears.com!

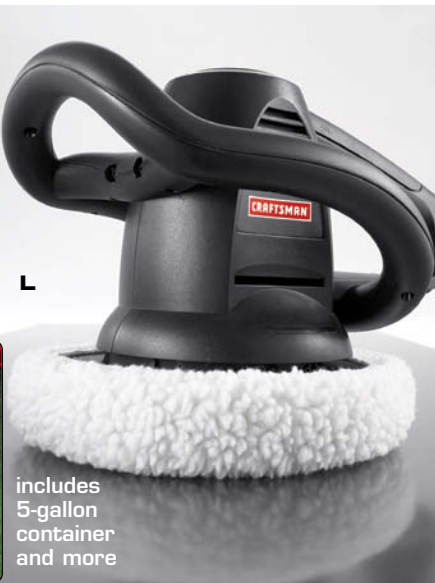

includes
5-gallon
container
and more

PORTABLE POWER TOOLS



Fixed-base router/table combo



built-in digital readout



A. Craftsman Fixed-Base Router/Table Combo. This powerful 9.5-amp, 1 3/4 hp motor delivers 25,000 rpm and features soft-start technology and live tool indicator. The 334 sq. in. router table has a smooth laminate worksurface, above table height adjustment, extended adjustable fence and 2 1/2-inch dust port. Wt. 26.5 lbs.
009-28180 129.99

B. Craftsman Professional 12.5 amp/Variable-Speed 2.25 hp Fixed-Base Router with Soft-Start Technology. This heavy-duty professional router cuts easily and smoothly through soft and hard woods, veneers and plastics. It accepts both 1/4 in. and 1/2 in. collets and provides variable speeds from 12,000-25,000 rpm (no-load). Electronic feedback control ensures the proper rpm for the bit size and material throughout the routing operation. Soft-start technology helps prevent router take-offs as the motor steadily revs to the desired speed. Includes replaceable brushes, fence, 10-foot cord and case. Wt. 8.2 lbs.
009-28190 129.99

C. Craftsman 10 amp, 2 hp Digital Plunge Router. The digital depth-of-cut scale allows for convenient setting of depths from 0 to 2 inches. 10 amp, 2 hp maximum developed motor delivers 15,000 to 25,000 rpm (no-load) speed. Features die cast aluminum base, adjustable depth stops, spindle lock, dust shield and vac attachment. Includes router, 1/4- and 1/2-inch collets, dust nozzle, depth rod and wrench. Warranted*. Wt. 13.2 lbs.
009-17517 149.99

Catalog/Online EXCLUSIVE
D. NEW Craftsman Professional 4-piece Fixed/Plunge/D-Handle and Palm Router Combo. Tackle all your routing projects with this versatile combo. The 12.5-amp, 2.25 hp router offers 6 variable speeds and delivers 12,000 to 25,000 rpm (no-load speed). The fixed base depth of cut is 1 3/4 inches. The plunge base depth of cut is 2 3/16 inches. The palm router delivers variable speeds of 18,000 to 28,000 rpm. Palm router transforms to a full-size router by attaching the dual-handled base. Both routers feature soft-start technology for smooth, steady operation. Wt. 23.39 lbs.
009-82724 279.99

E. Craftsman 11 amp, 2 hp Fixed and Plunge Base Router Featuring Soft-Start Technology. Variable speed, heavy-duty, permanently lubricated 100% ball bearing motor delivers 12,000-25,000 rpm. Soft-start permits the motor rpm to slowly increase to the desired speed setting. Electronic feedback control ensures the proper rpm for bit size and the material throughout the routing operation. Three integrated worklights clearly illuminate the worksurface. Die-cast aluminum motor housing adds strength while limiting and reducing vibration. Choose either the standard fixed base or dual-arm plunge base with depth gauge, turret stop and machined arms for smooth up/downward motion which plunges up to 2 3/16 inches. Each base features large, clear, 6 11/16-inch sub-base with square edge on the plunge. Oversized debris shield and vacuum shield provide a clear sightline to the bit. Spindle lock allows for easy bit exchanges. Live tool indicator lights up when power is connected. Router includes 1/4-inch and 1/2-inch collets, edge guide, bit wrench, operator's manual and storage case. Wt. 9.5 lbs.
009-17543 119.99

**BUY ONLINE
 PICK-UP IN STORE!**
 on eligible items

E NEW



INCLUDES
 "How To" Book

F. Craftsman Deluxe Router Pantograph with BONUS "How To" Book. Copies and cuts 3-dimensional engravings, 2-dimensional line drawings and letters and numbers. Reduces from patterns by 40, 50 and 60 percent. Comes with 10 line drawings, upper and lowercase letters in Old English, Far East, Script fonts and more. **BONUS** "Making Wood Signs" book. Wt. 8 lbs.
009-25187 54.99

*Warranted, see page 94a.



**MORE ROUTER BITS ONLINE
 AT SEARS.COM/SHOPTOOLS**



INTRODUCING
TREND®
ROUTER
ACCESSORIES



**MORE TREND ROUTING
ACCESSORIES AT
SEARS.COM/SHOPTOOLS**

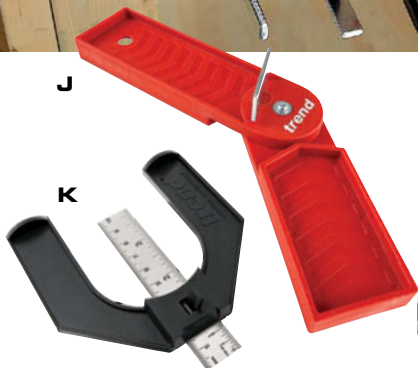

VARIJIG

Catalog/Online EXCLUSIVE

G. NEW Trend Mortise and Tenon Jig. Create mortise and tenons and dowel joints with your plunge router using this innovative jig. Fully adjustable for compound angle joints up to 45 degrees. Reversible templates for round or square tenons. Tackles materials from 1/2 to 2 inches thick and 4 inches wide. Router not included. Wt. 14 lbs.
009-88355 **349.99**

Catalog/Online EXCLUSIVE

H. NEW Trend T4 Variable Speed 1.1 hp Plunge Router. This light-duty plunge router is ideal for creating inlays, signs and other detailed projects. Features removable base with 1 5/8-inch collar for carving, die grinding and pillar drill fitment. Includes adjustable twin rod side-fence, 1/4 and 5/16-inch bolt-on dust spout, 5/8-inch template guide and case. Warranted*.
Wt. 4.2 lbs.
009-82727 **129.99**

J. NEW Trend Mitre Guide. Ideal for cutting frames, skirting, archtraves and beading, this guide halves miter angle for correct cutting angle. Sets internal and external angles. Wt. 0.4 lb.
009-88392 **19.99**

K. NEW Trend Depth Gauge. Sturdy design features inch/metric scale metal rule, 2 3/8-in. wide aperture, 3 3/16-in. measurement range, cam lever lock, and low profile for back fence adjustment. Wt. 0.1 lb.
009-88391 **12.99**

L. NEW Trend Varijig. Extremely versatile, this adjustable frame allows your router to cut recesses, slots, face panel moulds and more. Features inch and metric scales and offers a working area of 23 1/2 x 23 1/2 in. Offers .005-in. cross-cut accuracy. Use with standard clamps. Comes with anti-tilt block. Wt. 5.4 lbs.
009-88358 **99.99**

M. NEW Trend Multi-Scribe. Accurately transfer contours from one shape to another on a variety of materials using this innovative tool. Features 15 functions including parallel, convex, contour scribing and line block. Features steel blade with 3/16-inch and 1/4-inch gradations, as well as built-in pencil sharpener. Wt. 1 lb.
009-88393 **59.99**

Catalog/Online EXCLUSIVE

N. NEW Trend 30-pc. Router Bit Set. Crafted in tough tungsten carbide-tipped steel, this versatile set features a wide range of bits including bearing guided tools. Ideal for grooving, profiling, moulding and decorative woodworking projects. Case features flip lid for easy access. Wt. 3.5 lbs.
009-82728 **149.99**



TONY'S PICK



P. NEW Trend AIR/PRO Air Circulating Face Shield. High-tech protection for all woodworking applications, this powered polycarbonate face shield with hood has high-efficiency twin filters for excellent protection against harmful dust. Designed for comfort, unit features unique visor design for improved field of vision, rear-positioned motor for noise reduction and optional attachable ear protection, available separately. Operates for 8 hours with rechargeable NiMH battery pack. Wt. 4.8 lbs.
009-88346 **399.99**

Q. NEW AIRSHIELD Air Circulating Face Shield. This air-circulating face shield features a quiet fan that delivers a steady flow of filtered air across face. Protects against harmful dust with pre and fine dust filters. Polycarbonate flip visor protects eyes and face from flying debris. Includes rechargeable 4-hour NiMH battery and can be upgraded to 8-hour use with second battery pack, available separately. Wt. 3.5 lbs.
009-88351 **299.99**

Also Available
NEW AIRACE Half Mask. Design features a surface area five times larger than that of the average disposable mask for superior protection and savings. Vents down to prevent fogging of glasses and reduce clogging. The P2 electrostatic filters last 10 times longer than average disposable filters. Wt. 0.9 lb.
009-88354 **79.99**

ALL NEW



quiet air circulation fan

Professional rear positioned air circulation motor

PORTABLE POWER TOOLS



EVOLUTION PORTABLE POWER TOOLS

Built to perform dependably in the most challenging work conditions, Evolution Tools feature unparalleled technology and durability.

Catalog/Online EXCLUSIVE

A. Evolution 7 1/4-inch Fury Multipurpose Circular Saw. The newest addition to the Evolution family, the Fury saw cuts steel, aluminum, wood and plastic with no need for coolant, and with no burr and virtually no sparks. Collects wood and metal chippings automatically. Includes Fury blade. Warranted*. Wt. 17 lbs.
009-61257 99.99

Catalog/Online EXCLUSIVE

B. Evolution 9-inch 230HD Extreme Steel Cutting Saw. With 2 7/16-inch cutting reach, this heavy-duty saw is extremely tough. Features laser guidance and 0-45 bevel tilt. The 9-inch TCT blade and high-power take steel cutting technology to a new level. Large cutting capacity, yet still compact and portable. Includes steel cutting blade. Comes with safety goggles, ear protection and case. Warranted*. Wt. 32 lbs. ●
009-61255 399.99

Catalog/Online EXCLUSIVE

C. Evolution Rage 7 1/4-inch TCT Multipurpose Circular Saw. Cuts steel, aluminum, wood, nails, plastics and other metals quickly without coolant, burrs or sparks. Cutting depth of 5/8 inches. 0 to 45-degree bevel. Collects wood dust or metal chippings automatically. Rage blade system cuts up to 60 yards of 1/4-inch steel. Features overload protection, safety switch, visibility panel and debris guard. Complete with heavy-duty carrying case. Includes Rage blade, goggles, hearing protection, case and manual. Wt. 28 lbs.
009-25864 159.99

7 1/4-inch blades can also be used for 7 1/4-inch multi-purpose chop saw on page 175.

Catalog/Online EXCLUSIVE

D. Evolution Cyclone Magnetic Stick. Keep your work area clear of metal shavings with this lightweight tool. Pull plunger to deposit shavings in waste container. Wt. 5 lbs.
009-61256 14.99

Catalog/Online EXCLUSIVE

E. Evolution Cyclone Sweeper. Simply sweep over metal debris and shavings to collect with magnetic base. Pull collar to deposit shavings in waste container. Wt. 5.0 lb.
009-82836 29.99



Specialty Blades (7 1/4 inch)

Item	Catalog No.	Application	Arbor	Teeth	Wt., lbs.	Price
F.	009-61359	Rage Multipurpose	20 mm	20	0.60	\$29.99
G.	009-82828	Fury Multipurpose	20 mm	16	0.65	14.99
H.	009-82830	Diamond Masonry	20 mm	0	0.90	29.99
J.	009-82832	Fiber Cement Cutting	20 mm	6	0.55	14.99
K.	009-82833	Wood Cutting	20 mm	18	0.55	11.99
L.	009-82835	Steel Cutting	20 mm	40	0.85	39.99

*Warranted, see page 94a.

● See page 94a for laser use and precautions.

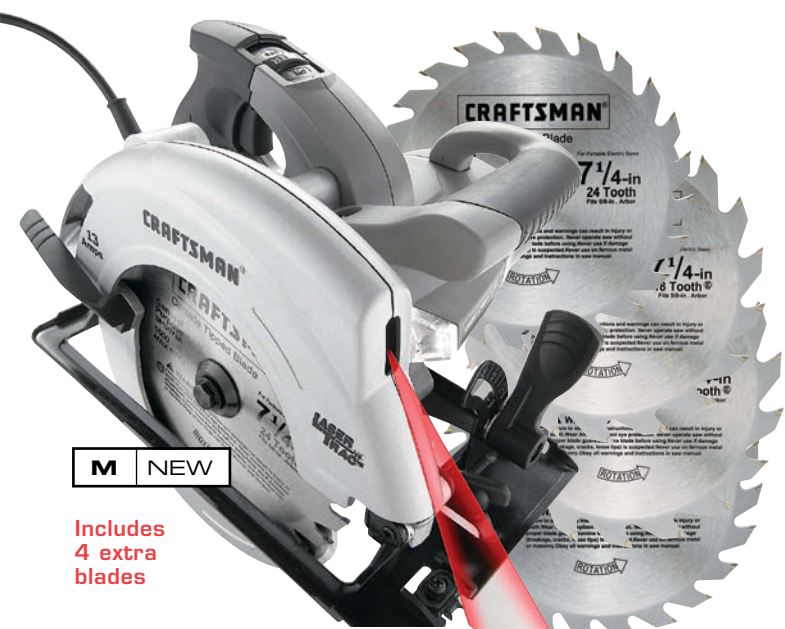

M NEW

Includes 4 extra blades



N NEW

includes 4 extra blades

CRAFTSMAN®

Catalog/Online EXCLUSIVE

M. NEW Craftsman 7 1/4-inch Circular Saw with LaserTrac™ and 5 blades. 13-amp saw features durable Craftsman motor that delivers 5,000 rpm, integrated LED worklight to illuminate the work surface and a live tool indicator. Oversized locking levers allow for quick and easy table adjustments. Includes spindle lock, 5 assorted blades, edge guide and carry case. Wt. 18.2 lbs. ●
009-79570.....89.99

Catalog/Online EXCLUSIVE

N. NEW Craftsman Professional 7 1/4-inch Hypoid Saw and 5 1/2-inch Trim Saw Combo. Lightweight hypoid saw features a 15-amp motor that delivers 4,400 rpm electric brake, spindle lock and comes with 5 Freud blades. Trim saw features 8-amp motor that delivers 4,000 rpm. Includes spindle lock, laser guide line, LED work light and comes with 5 trim blades. Wt. 37.7 lbs.
009-79571.....279.99

Catalog/Online EXCLUSIVE

P. Craftsman 7 1/4-inch 13-amp Circular Saw with LaserTrac™ and LED Worklight. The 100% ball-bearing motor provides 5,000 rpm to cut, rip or plunge through soft and hard woods. A machined gearbox provides efficient power transfer. Features spindle lock, an electric powered on-demand LaserTrac™ laser and a 24-tooth carbide-tipped blade that lasts ten times longer than a steel blade. Also comes with an 18-tooth and 40-tooth carbide-tipped blade. Wt. 12.2 lbs. ●
009-61260.....69.99

Catalog/Online EXCLUSIVE

Q. 7 1/4-inch 14-amp Circular Saw with LaserTrac™ and LED Worklight. The 100% ball-bearing, permanently lubricated motor delivers 5,000 rpm. Cut greater angles with the extreme 55 degree bevel capacity. The solid, machined aluminum oversized shoe is lightweight yet strong. Ergonomic "D" grip and ball style handles with rubber overmold provide comfort and reduce fatigue. Includes spindle lock, one 18-tooth and 40-tooth carbide-tipped blade. Wt. 12.5 lbs. ●
009-61261.....89.99

Catalog/Online EXCLUSIVE

R. Craftsman Professional 7 1/4 in. 15-amp Contractor Circular Saw. The lightest circular saw ever from Craftsman – only 9.4 lbs. A powerful Craftsman 100% permanently sealed and lubricated ball-bearing motor delivers 15 amps of power at 5,200 rpm to cut through the most demanding materials. The electric brake stops the exclusive Freud Avanti 24-tooth carbide-tipped blade within 3 seconds of releasing the trigger. Includes a 24-tooth carbide-tipped Freud Avanti blade and case. Wt. 9.4 lbs.
009-61259.....139.99



P



Q



R

CUSTOMER review
 “This saw is absolutely awesome. Smooth cuts, and easy to use. I will definitely recommend this saw to anyone.”
 JGib48
 Borden, IN

P thru R include two carbide-tipped blades

S. Craftsman Professional 7 1/4 in. 15-amp LaserTrac™ Circular Saw with Worklight. 15-amp, 100% permanently lubricated ball-bearing motor delivers 5,200 rpm (no-load). Features include: magnesium upper and lower blade guards, oversized magnesium shoe, lower blade guard with anti-sag tooth and ergonomic “D” and palm grip handles that provide comfort and reduce fatigue. A spindle lock is featured for easy blade removal. Includes one 18-tooth, 24-tooth and 40-tooth carbide-tipped blade and case. Wt. 19.13 lbs. ●
009-61258.....109.99



S

adjust cut-width in seconds

T. Craftsman Circular/Jigsaw Guide. Universal circle and edge guide for left or right hand use with circular and jig saws. Includes 4 metal bars and edge guide head that allows for cuts up to 10" from edge. Innovative design allows easy adjustment of cuts by 1/8" without tools.
009-26320.....9.99



T

U. Craftsman Accu-Rip Saw Guide. The Craftsman Accu-Rip takes the guesswork out of rip measurements. Adjusts to fit most right hand circular saws. Makes accurate rip cuts up to 24 inches wide. Requires no tools for assembly. Patented. Wt. 1.44 lbs.
009-25980.....39.99

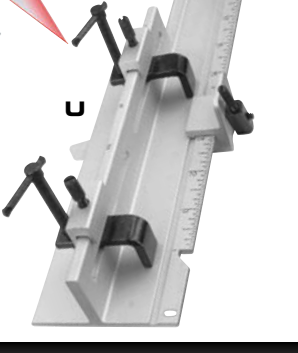

U

A NEW

active cancelling technology
vibrafree™
AIPLS1166™



B



INCLUDES BAG
For B & C Reciprocating Saws.



INCLUDES CASE
For A & D Reciprocating Saw.



CUSTOMER review

“Thanks again Craftsman, keep up the good work.”
Westcoast DIY
San Diego, CA

C

D



RECIPROCATING & SABER SAW BLADE OPEN STOCK AT SEARS.COM/SHOPTOOLS



A. NEW Craftsman Professional 12 amp Reciprocating Saw with Case. Engineered with new vibrafree™ technology that reduces tool vibration by over 56% when compared to Craftsman reciprocating saw #25290. Variable-speed trigger delivers 0-3,000 spm. 4-position orbital blade selection matches orbiting action to material. Integrated LED worklight illuminates the work area. Features tool-free blade change and adjustable front shoe. Includes saw, 3 blades and case. Wt. 11 lbs. **009-26043149.99**

B. Craftsman 8 amp Reciprocating Saw. 8 amp motor provides variable-speed 0-2,500 spm (no-load speed). Features built-in LED light, full 1 1/8-inch blade stroke, adjustable pivoting shoe, toolless blade clamp, trigger switch, rubber boot and ergonomic rear handle. Includes carrying bag and 3-piece blade assortment. Warranted*. Wt. 10.14 lbs. **009-1718379.99**

C. Craftsman 10 amp Reciprocating Saw. Powerful 10 amp motor provides variable-speed 0-2,700 spm (no-load speed). Delivers a full 1 1/8-inch blade stroke for fast cutting. Built-in LED light, adjustable pivoting shoe, toolless blade clamp for fast change, trigger switch, rubber boot and ergonomic rear handle. Includes soft carrying bag and 3-piece blade assortment. Warranted*. Wt. 10.14 lbs. **009-1718499.99**

D. Craftsman Professional 12 amp Reciprocating Saw. Offers 0-3,000 spm (no-load speed) with a 1 1/4 in. stroke. Adjustable front shoe, variable-speed trigger, toolless blade change. Fully lubricated ball- and-roller-bearing operation. 4-position orbital action cutting which matches the cut to the material. 10-ft. rubber cord. Includes a storage case with a three-blade assortment. Warranted*. Wt. 15.5 lbs. **009-25290129.99**

Catalog/Online EXCLUSIVE
E. NEW Craftsman 4.5 amp Jig Saw with LED Worklight and 10 Extra Blades. Features durable Craftsman motor that delivers 800-3,000 spm, an integrated LED worklight to illuminate the work surface and a live tool indicator. Oversized blade clamp allows for quick and easy blade changes. Includes saw, 10 assorted blades, edge guide and carry case. Wt. 8.9 lbs. **009-7957449.99**

Catalog/Online EXCLUSIVE
F. NEW Craftsman LaserTrac™ 5.5 amp Jig Saw with LED Worklight and 10 Extra Blades. Delivers 800-3,000 spm and features an on-demand LaserTrac™ laser guideline. 5-position orbital blade selection switch adjusts orbiting action. Integrated LED worklight illuminates the work area. Live tool indicator. Includes saw, 10 assorted blades, laser-enhancing glasses, bevel assist handle, edge guide and carry case. Wt. 11.7 lbs. **009-7957579.99**

G. Craftsman 5 amp Orbital Scrolling Sabre Saw. Equipped with the first-ever on-board bevel assist handle. Heavy-duty, permanently lubricated 100% ball-bearing variable-speed motor delivers 800-3,000 spm. 15 1/16 in. blade stroke provides smooth and efficient cuts. Toolless blade change allows for quick blade exchange. Accepts both U- and T-shank blades. Oversized die-cast aluminum base. Bevel capacity of 0 to 45 degrees left and right. Scroll saw includes: bevel-assist handle, blades, operator's manual and storage case. Wt. 9.11 lbs. **009-1725579.99**

F NEW

INCLUDES 10 BLADES



E NEW

INCLUDES 10 BLADES



G



H. 7-INCH PROFESSIONAL

H. Craftsman Professional 7-inch Angle Grinder. High-power 13 amp, 8,000 rpm motor with overload protection. Lightweight, with a low-profile gear case, improved ergonomics and two-position side handle allows extended use in demanding applications. Includes grinding wheel, guard and wrench. Wt. 11.6 lbs.

009-26438 109.99

J. Craftsman 4 1/2-inch Angle Grinder. Powerful 7 amp, 10,000 rpm motor with overload protection. Metal gear case dissipates heat for longer life. Locking paddle switch, three-position side handle. AC/DC capacity works off welding machines and generators. Spindle lock for easy wheel changes. Matched wheel flanges accepts common accessories. Includes two 4 1/2-inch grinding wheels, guard and wrench. Wt. 6.7 lbs.

009-11651 49.99



K

L

M

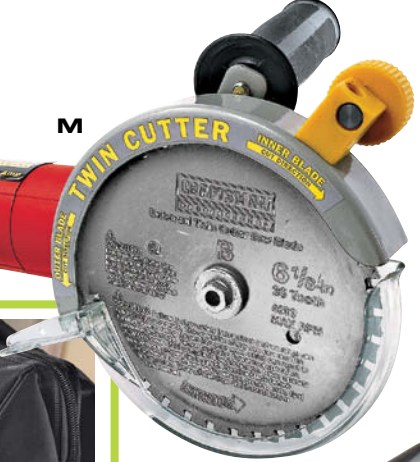

TWIN CUTTER

K. Craftsman Professional 4 1/2-inch Angle Grinder with Paddle Switch. Powerful 7.5 amp, 10,000 rpm motor with overload protection. Metal gear case dissipates heat for longer life. Locking paddle switch with two-position removable side handle. Spindle lock for quick wheel changes. Includes grinding wheel, guard and wrench. Wt. 6.2 lbs.

009-26437 59.99

L. Craftsman 4-inch Grinder. Powerful 6 amp AC, 10,000 rpm motor. Features two-position removable side handle for comfort and control. Spindle lock for quick, easy wheel changes. 5/8-inch, 11-spindle thread accepts a wide range of 4 1/2-inch accessories. With three 4-inch grinding wheels, wire cup, guard, wrench and case. Wt. 7.9 lbs.

009-11650 39.99

M. Craftsman Professional Twin-Cutter Circular Saw. Features patented technology that allows twin blades to rotate in opposite directions to reduce vibration. Powered by a 7.8 amp motor. 6 1/8-inch carbide tip blades cut quickly and cleanly through wood, metal and plastic. Warranted*. Wt. 12.3 lbs.

009-25574 169.99

Catalog/Online EXCLUSIVE

N. Stout 18-volt X-Band Cordless Band Saw Kit. Easy-to-use portable one-hand operation, cordless band saw. Durable, lightweight design (only 9 lbs.) features heavy-duty, high-torque motor that delivers a constant cutting speed of 475 fpm. Impact-resistant fiberglass housing and sealed bearings for long-lasting performance. Features quick-change blade release. 2 1/2 x 2 1/2-in. throat. Includes two rechargeable NiCad batteries, trickle charger, 14/18 TPI bi-metal cobalt blade for metal cutting and canvas case. Model #STX-250B. Warranted*. Wt. 17.6 lbs.

009-64850 199.99

P. Stout 18-volt X-Band Contractor Band Saw Kit. All of the convenience and performance of the X-Band saw, but with two heavy-duty Pro 200 batteries. Durable and lightweight saw features a heavy-duty, high-torque motor that delivers a constant cutting speed of 475 fpm. Cuts over 150 pieces of 1-inch steel conduit per battery charge. Impact-resistant housing and sealed bearings. Includes 1-hour charger, 14/18 TPI bi-metal cobalt blade for metal cutting, and hard storage case. Model #STX-250C. Warranted*. Wt. 25.5 lbs.

009-64851 299.99

Also Available

Stout STM-130 3-pack of 14/18 TPI Band Saw Blades. Bi-metal cobalt general use metal-cutting band saw blades for Stout STX-250B and STX-250C band saws. Wt. 6 oz.

009-74955 21.99

Stout STM-129 2-pack of 24 TPI Band Saw Blades. Bi-metal cobalt fine metal-cutting blades for Stout STX-250B and STX-250C band saws. Wt. 6 oz.

009-74954 21.99

Stout STM-135 2-pack of 6 TPI Band Saw Blades. Wood/PVC-cutting blades. Wt. 0.61 oz.

009-74956 21.99

Q. Stout Portable X-Band Saw Cutting Station. Turns your X-Band saw into a benchtop vertical band saw. The base is made of impact-resistant nylon with a 1-inch thick machined table, magnetic on/off switch, all-metal lock-down arm and removable blade guard that provides a durable and safe cutting experience. Fits STX-250B and STX-250C saws. Model #ST-CS-250. Warranted*. Wt. 13.22 lbs.

009-64852 69.99



DREMEL
Tools for the Imagination

R. DREMEL® Multi-Max Oscillating Tool Kit. Offers do-it-yourselfers and pros a versatile and effective multitasking tool. With fast side-to-side motion, the Multi-Max can take on a variety of projects that involve repair, remodeling, or restoration. Powerful 1.5 amp motor that provides 10,000 – 21,000 opm wide speed range – for optimal control. Electronic feedback circuitry for consistent speed under load. Quick FIT™ feature – for faster accessory changes. Kit includes Dremel Multi-Max Tool, 3 sanding sheets, 3/4" wood flush cut blade, 3" wood and drywall saw blade, hook and loop pad, flexible scraper and carrying case. Wt. 4.7 lbs.

009-17261 99.99

*Warranted, see page 94a.
● See page 94a for laser use and precautions.



Catalog/Online EXCLUSIVE

A. NEW Rockwell® 18-volt Pro-Grade Combo Kit. Offers great value and versatility! This kit comes loaded in a handy, durable ballistic-nylon tool bag with two 18V PowerTank™ batteries and charger so you're never without power. Drill/driver delivers 485 in.-lbs. of torque with a 1/2-inch No-Key chuck and 24-position clutch. Trim saw has aluminum guard with vac port, cutting capacity 1 5/8-in. at 90 degrees, 13/16-in. at 45 degrees and pivoting foot plate for bevel cuts up to 50 degrees. Reciprocating saw features 3-position orbital cutting action, counterbalancing mechanism to reduce vibration, variable speed trigger and pivoting foot plate. Worklight has a 310-degree rotating head and provides 80 minutes of light on a single charge. Wt. 28.66 lbs.

009-88680 299.99

B. NEW Rockwell® 1/2-inch 18-volt Drill/Driver. Features 24-position torque collar, magnetic fastener tray and bubble level. Delivers 485 in.-lbs. of maximum torque. Driver mode 0-350 rpm for high torque and drilling mode 0-1,300 rpm for high speed. 1/2-inch No-Key chuck with shaft lock for one-hand operation. Includes drill, removable side handle, two batteries, charger, two double-end bits and case. Wt. 10.2 lbs.

009-88681 159.99

C. NEW Rockwell® 1/2-inch 18-volt Impact Drill. Lightweight drill carries a hefty 2-speed motor capable of 530 in.-lbs. of driving torque. Easily switches from normal drilling to hammer action. 24-position torque collar, magnetic fastener tray, bubble level and two-finger trigger. Driver mode delivers 0-350 rpm, drilling mode 0-1,300 rpm and impact mode (0-5,600 bpm in gear 1 and 0-20,800 bpm in gear 2). Includes drill, removable side handle, two batteries, charger, two double-end bits and case. Wt. 10.36 lbs.

009-88725 179.99

D. NEW Rockwell® 3/8-inch 14.4-volt Drill/Driver. 14.4V cordless drill/driver is lightweight but carries a hefty 2-speed (0-350 rpm and 0-1,200 rpm) motor capable of 310 in.-lbs. of driving torque. The Rockwell® cordless drill/driver is user-friendly and includes features like 24-position torque collar, magnetic fastener tray, bubble level and two-finger trigger. Includes drill, two batteries, charger, two double-end bits and case. Wt. 9.26 lbs.

009-88892 129.99



ALL NEW

FREE FOR LIFE!

Catalog/Online EXCLUSIVE

E. NEW Rockwell® 18-volt Jig Saw with Orbiting Action. Features 4-position orbital action, cast aluminum base and gear box, edge guide and tool-free blade change. Variable speed trigger with soft grip for added comfort. Includes saw, two batteries, charger, two blades and case. Wt. 12.79 lbs.

009-88737 169.99

Also Available Jig Saw Only. Wt. 6.61 lbs.

009-88757 109.99

Catalog/Online EXCLUSIVE

F. NEW Rockwell® 18-volt Reciprocating Saw. Cordless reciprocating saw has variable speed and 3 orbital cutting positions, counter-balancing mechanism to reduce vibration, tool-free blade change system, variable speed trigger and soft grip for added comfort. Cast aluminum gear case for durability. Includes one blade, two batteries, charger and case. Wt. 12.8 lbs.

009-88765 169.99

Also Available Reciprocating Saw Only. Wt. 6.61 lbs.

009-88838 109.99

Catalog/Online EXCLUSIVE

G. NEW Rockwell® 4 1/2-inch Pro-Grade 6 amp Angle Grinder. Offers durability and power in slim, easy-to-hold bodies. Features cast aluminum gear housing, all-metal gear boxes and quick-lock adjustable guards. Two-position auxiliary handle for enhanced control. Spindle lock for easy disc replacement. Wt. 8.82 lbs.

009-89181 79.99

Catalog/Online EXCLUSIVE

H. NEW Rockwell® 7-inch Pro-Grade 15 amp Angle Grinder. Slim body design ensures a secure grip at all times. Soft Start eliminates twisting forces on start-up. Cast aluminum gear housing for durability. Three-position auxiliary handle, anti-vibration handle and enlarged trigger for control and comfort. Wt. 17.64 lbs.

009-89182 149.99

J. Rockwell Pro-Grade Cordless NiCad Batteries feature slim-line design, extended run times and Klik-Loc™ connectors. Multiple Voltage Charger circuitry identifies problems to eliminate overcharging. If, during the life of your Rockwell tool, the battery ever fails, you may receive a replacement battery free of charge. Call toll free 866-514-7625 (ROCK) or visit rockwelltools.com for complete information.

Pro-Grade Batteries.
RW2717 14 volt. Wt. 0.9 lb.

009-88902 49.99

RW2817 18 volt. Wt. 1.9 lb.

009-88908 59.99

Pro-Grade Universal Charger.
RW2801 18 volt. Wt. 3.7 lbs.

009-88909 59.99



K

SoniCrafter™

These multifunction tool kits allow you to scrape, saw, sand, polish and more with one innovative tool. SoniCrafter™ unit features slim body for easy grip, lightweight magnesium gear housing and a 2.3 amp motor that delivers up to 20,000 opm. Also has soft grip handle and 10-foot cord.

Catalog/Online EXCLUSIVE

K. NEW Rockwell® 20-piece SoniCrafter™ Multifunction Tool Kit with Bag. Includes 20,000 opm SoniCrafter™ unit, Allen wrench, HSS segment blade, universal end cut blade, scraper, carbide grit segment blade, sanding pad and 30 sanding sheets. Wt. 6.2 lbs.

009-89173 119.99

Also Available NEW Rockwell® 37-piece SoniCrafter™ Kit with Bag. Includes 11,000-20,000 opm SoniCrafter™ unit, Allen wrench, HSS segment blade, universal end cut blade, scraper, carbide grit segment blade, sanding pad and 30 sanding sheets. Wt. 6.6 lbs.

009-89174 149.99

NEW Rockwell® 72-piece SoniCrafter™ Kit with Bag. Includes 11,000-20,000 opm SoniCrafter™ unit, Allen wrench, HSS segment blade, universal end cut blade, scraper, carbide grit segment blade, carbide rasp triangle, 2 felt polishing pads, detail sanding finger pad, sanding pad, vacuum kit and 60 sanding sheets. Wt. 7.1 lbs.

009-89175 189.99



INNOVATIVE MILWAUKEE TOOLS WITH LITHIUM-ION POWER

PORTABLE POWER TOOLS

Catalog/Online EXCLUSIVE

L. NEW Milwaukee® M12 Cordless Screwdriver and Hackzall™ Combo. Lightweight, compact Hackzall cuts over 80 1 1/2-inch PVC pipes or 90 feet of drywall on one charge. Quick bit loading screwdriver delivers 100 in./lb of torque. Both tools feature a built-in LED light and battery fuel gauge. Comes with two batteries, two saw blades, charger and contractor bag. Wt. 9.21 lbs.
009-82704.....259.99

Catalog/Online EXCLUSIVE

M. NEW Milwaukee® 12-volt Lithium-Ion Subcompact Drill Kit. Delivers 100 in.-lbs. of torque and 0-500 rpm. Drives 130 screws on a single charge. Features battery fuel gauge, one-handed bit loading, metal gear housing and built-in LED light. Includes charger. Wt. 5.2 lbs.
009-89638.....129.99

Catalog/Online EXCLUSIVE

N. NEW Milwaukee® M12 Cordless Impact Drill. Delivering "best-in-class" 850 in.-lbs. of torque and 0-3,000 imp, this compact 2.3-pound impact drill drive fastener up to 75 percent faster and runs up to 2 times longer. Includes 2 batteries, charger and case. Wt. 7.1 lbs.
009-82708.....189.99

Catalog/Online EXCLUSIVE

P. NEW Milwaukee® M12 Cordless M-Spector Digital Inspection Camera. Delivers higher resolution images on a 2.4-inch color LCD display. Camera features LED brightness control with glare reduction, digital zoom and auto shut-off. Handle features up-front controls for one-handed operation. Includes camera, 3-foot waterproof cord, battery, charger and case. Wt. 7.5 lbs.
009-82705.....259.99



ALL NEW

SHOP ON THE GO!
Visit sears2go.com on your mobile device



Catalog/Online EXCLUSIVE

Q. NEW Milwaukee® M12 Hackzall™. This compact, lightweight reciprocating saw is designed for effective cutting in tight spaces. Cuts over 80 1 1/2-inch PVC pipes or 90 feet of drywall on one charge. Features 1/2-inch stroke, Quick-Lok blade clamp, variable-speed trigger and built-in LED light. Comes with 2 blades, battery, charger and case. Wt. 5.2 lbs.
009-82707.....179.99

Catalog/Online EXCLUSIVE

R. NEW Milwaukee® M12 Cordless Tubing Cutter. Speed through precision cuts on copper tubing from 3/8 to 1 inch in diameter. Performs over 200 cuts per charge. Inline design increases access and reduces fatigue. Includes battery, charger and case. Wt. 8.6 lbs.
009-82709.....219.99

Catalog/Online EXCLUSIVE

S. NEW Milwaukee® M12 Lithium-Ion Replacement Battery. Lightweight, ergonomic battery delivers longer run time and life with fade-free power. 1.4-amp hour battery. Wt. 1 lb.
009-82711.....39.99

Catalog/Online EXCLUSIVE

T. NEW Milwaukee® M12 Lithium-Ion Battery Charger. Fast, 30-minute charger for Milwaukee M12 lithium-ion batteries. Wt. 2.5 lbs.
009-82712.....49.99

Catalog/Online EXCLUSIVE

U. NEW Milwaukee® M12 Cordless Worklight. Hands-free light in a compact, lightweight unit, this light features a 90-degree tilting head, integrated magnet and bright Xenon incandescent bulb. Runs on 12-volt lithium-ion battery (not included). Wt. 1 lb.
009-82706.....19.99

*Warranted, see page 94a.



Catalog/Online EXCLUSIVE

A. Gyros® PowerPro™ Rotary Tool. Perfect for carving, grinding, cutting, drilling and more. The 1.2-amp motor powers through most projects. Comes with a flex shaft extension, telescopic tool holder, cutting guide, attachable EZ-Lite™ and 85 accessories. Wt. 6 lbs.

009-6123149.99

Catalog/Online EXCLUSIVE

B. GyrosGuard Safety Shield Kit.

Up to 1 1/2-in. diameter capacity. Kit includes safety shield, 1 1/2-in. Fiber Disk™, stainless steel mandrel. Wt. 0.19 lb.

009-6123224.99

Catalog/Online EXCLUSIVE

C. Gyros® 7-piece Fiber Disk™ ProPak.

Includes 1 each: 7/8-in. ripsaw, 1-in. coarse-teeth blade, 1 1/4-in. fine-teeth blade, stainless steel mandrel, 1 1/2-in. ST Fiber Disk™, 1 1/2-in. HT Fiber Disk™, 1 1/2-in. LT Fiber Disk™. Wt. 0.18 lb.

009-6123337.99

Catalog/Online EXCLUSIVE

D. NEW Gyros® Power Pro 9.6-volt Cordless Variable Speed Rotary Tool. Carve, grind, polish, sand, cut and more with this high-speed rotary tool. Complete with a wide selection of 50 accessories, including a flexible shaft extension, EZ-Lite™, 1/8 and 3/32-inch collets and two NiMH batteries.

Wt. 5.75 lbs.
009-8272154.99

Catalog/Online EXCLUSIVE

E. NEW Gyros® MAGNALite™ Pro 7.2-volt 36-LED Work Lamp. This portable cordless light features a "cool-to-the-touch" light, a strong magnetized bottom and a 120-degree pivoting range. Powered by a rechargeable lithium battery that runs up to 6 hours per charge. Wt. 1.04 lbs.

009-7954349.99

INCLUDES

case and accessories

Save \$10—mail-in rebate on Gyros Safety Shield with purchase of Gyros Rotary Tool



includes two NiMH batteries!

120 degree pivoting range

magnetized bottom

Also Available

NEW Gyros® MAGNALite™ 7.2-volt 26-LED Work Lamp. Runs up to 7 hours per charge. Wt. 1.04 lbs.

009-7954239.99

NEW Gyros® MAGNALite™ 3.6-volt 26-LED Work Lamp. With spotlight function. Runs up to 5 hours per charge. Wt. 0.09 lb.

009-7954129.99



F

H

CRAFTSMAN

F. Craftsman 4.8-volt Cordless Rotary Tool with Five Accessories.

Lightweight, balanced design for precise control. High/low speed switch lets you match the speed to the accessory and material. Includes quick-change keyless collet nut, 1/8 in. collet, 3 hr. battery charger, silicon carbide grinding stone, polishing wheel, sanding drum and band, screw mandrel. High-impact housing helps protect tool from damage and reduces weight. Wt. 1.25 lbs.

009-6107834.99

G. Craftsman Variable Speed Rotary Tool Kit.

Designed to deliver the precision and control to complete a wide range of projects, this variable speed tool is perfect for sanding, grinding, cutting, sharpening and drilling. Features a soft-grip body for comfort and control, replaceable brushes, multipurpose cutting tool guide attachment, flex light attachment and 35 accessories. Includes bit box and storage case. Wt. 3.37 lbs.

009-6113969.99

H. Craftsman Engraver Set. For precision engraving in metal, glass, wood, plastic, ceramic and leather. Comfort grip housing for better handling. Protect your valuables with code numbers for easy identification. With carbide steel general-purpose tip and letter/number template. Wt. 1 lb.

009-6105024.99

J NEW



Catalog/Online EXCLUSIVE

J. NEW Stanley® 72-piece Fast Change Drill/Drive Set.

This multi-material set features 1/4-inch hex shank accessories that prevent tool spin-out. Also included is the fast change connector which eliminates chucking and re-chucking to change tools. Fourteen 1/4-inch hex shank titanium-coated drill bits: 1/16 (2), 5/64, 3/32, 7/64, 1/8, 9/64, 5/32, 11/64, 3/16, 13/64, 7/32, 15/64, 1/4 in. Compact screw guide, fast change connector, seven 2-inch power bits, twenty-five 1-inch insert bits, four nutsetters, one each: 1/4, 5/16, 3/8, 7/16 in. Standard #8 drill and driver, six brad point drill bits, one each: 3/32, 1/8, 5/32, 3/16, 7/32, 1/4 in. Three masonry drill bits, one each: 1/8, 3/16, 1/4 in. Four wood boring drill bits, one each: 3/8, 1/2, 3/4, 1 in. Two replacement drill bits in tube: 7/64 in. Two set screws. Wt. 4.15 lbs.

009-8969129.99

INTRODUCING NEXTEC™ 12-VOLT POWER TOOLS

CRAFTSMAN®
NEXTEC™

These NEXTEC™ products have been ergonomically designed and engineered by Craftsman to meet the high demands of the next generation of Do-It-Yourselfers. Craftsman has built the most advanced features, portability and power into every quality NEXTEC™ product so that you can accomplish even the most challenging projects with confidence.

These awesome tools are light, dependable and powered by lithium-ion batteries.

TONY'S PICK



Check online for **SALE PRICING!**

K. NEW Craftsman NEXTEC™ Drill, Multi-Saw and Worklight Combo. Lightweight and ergonomically designed for any DIY project, this innovative 3-tool combo is powered by our new 12-volt lithium-ion battery that delivers enhanced performance and a longer shelf life. The combo includes a 3/8-in. drill/driver with 195 in.-lbs. of torque, an innovative multi-saw that functions as both a sabre saw and reciprocating saw, a luminous 24-bulb LED work light with rotating head, two 12-volt lithium-ion batteries, a 30-minute charger and a handsome storage case. Wt. 14 lbs.

009-11890 149.99

L. NEW Craftsman NEXTEC™ 12-Volt Lithium-Ion 3/8-Inch Reversible Drill/Driver. Compact and lightweight, this powerful drill/driver features our new lithium-ion battery that delivers enhanced performance and a longer shelf life. The tool features a 2-speed gearbox that delivers 195 in.-lbs. of torque and 0-400/0-1,300 rpm for high torque and high-speed drilling and driving. Also features a trigger-activated LED work light, 18-position clutch and a soft-grip overmold handle. Includes two lithium-ion batteries, 30-minute quick charger, and a soft case. Warranted*. Wt. 7.67 lbs.

009-11812 89.99

M. NEW Craftsman NEXTEC™ 12-Volt Lithium-Ion Auto Hammer. The first of its kind, the Hammerhead auto hammer delivers up to 3,600 impacts per minute without cord or hose. Drives nails up to 3 1/2-inches long with the press of the trigger. Retractable nail sleeve ensures flush finish. Magnetic head holds nails. Features LED work light. Includes battery, charger, nail remover and case. Wt. 5.88 lbs.

009-11818 99.99

*Warranted, see page 94a.
◆ See "N" suffix note on page 94a.



ALL NEW

STORAGE CASE included with combo, drill driver and auto hammer



PORTABLE POWER TOOLS

CRAFTSMAN



INCLUDES 2 BATTERIES, BAG, BITS AND CHARGER

A NEW

built-in LED worklight



B includes storage bag



B



C

D NEW



6-inch and 18 inch extension bit holder available online

NEW! quick release extension bit holders

A. NEW Craftsman C3 Compact Lithium 1/2-inch Reversible Drill/Driver. Powerful drill/driver features the new lithium battery that delivers enhanced performance and longer shelf life. Features a 2-speed gearbox that delivers 0-400 and 0-1,600 rpm, built-in LED work light, 2 energy indicators (one on battery, one on drill), 24-position clutch and keyless chuck. Includes two lithium-ion batteries, bag, 2 double-ended bits, and multi-chemistry charger that will charge your NiCad and lithium-ion 19.2V DieHard® batteries. Wt. 4.8 lbs.
009-11910.....179.99

Catalog/Online EXCLUSIVE
B. Craftsman C3 19.2-volt 4-piece Lithium-Ion Combo Kit. Exclusive 19.2-volt lithium-ion powered C3 tool combo includes a 1/2-inch drill/driver with over 420 in.-lbs. of torque, 2-speed gear box (0-400/0-1,400 rpm), 24-position adjustable torque clutch, built-in LED and assist handle, full-size 7 1/4 in. circular saw with front and rear lasers, impact driver with over 900 in.-lbs. torque, built-in LED and quick-release 1/4-inch collet and reciprocating saw with 7/8 in. blade stroke, variable speed (0-3,100 spm), built-in LEDs, toolless blade clamp and adjustable foot. Includes two 19.2-volt DieHard® lithium-ion batteries, 1-hour lithium-ion charger and large tool bag. Lithium-ion batteries and charger are compatible with all Craftsman C3 add-on tools. Wt. 26 lbs. ●
009-11644.....429.99

C. Craftsman C3 19.2-volt Lithium-Ion Drill/Impact Driver Combo. All the benefits of lithium-ion technology, such as lighter weight and better performance, are now available in a Craftsman C3 combo kit. This two-piece kit consists of a 1/2-inch drill/driver with over 420 in.-lbs. of torque, 2-speed gear box (0-400/0-1,400 rpm), 24-position adjustable torque clutch, built-in LED and assist handle. The impact driver produces over 900 in.-lbs. of torque to handle any driving needs, a built-in LED light and a 1/4-inch quick-release collet. Combo includes a 19.2-volt lithium-ion battery and 1-hour lithium-ion charger. Lithium-ion batteries and charger are compatible with all Craftsman C3 add-on tools. Wt. 13 lbs.
009-11642.....219.99

D. NEW Titan® 12-inch Quick Release Extension Bit Holder. Extended driver for hard-to-reach areas. Auto-locking drive is magnetic and low profile for easy use. Wt. 0.36 lb.
009-90157.....9.99

E. NEW BOSCH® 12V MAX Litheon™ Pocket Driver™. Compact design for working in tight spaces with a locking 1/4" universal magnetized bit holder, the Pocket Driver develops speeds to 500 rpm and improved torque by 25% over 10.8V Pocket Driver. Motorized brake and LED light. Wt. 4.7 lbs.
009-89948.....129.99

Catalog/Online EXCLUSIVE
F. NEW WIHA® 21-piece Power Bit Set with Rapid Fix Bit Changer and Belt Clip Bit Holder. Designed for optimum speed, efficiency and accessibility, this set features a slim 1/4-inch quick-release bit holder with a multi-point internal bit lock for exceptional grip. Includes 3 slotted, 3 Phillips, 3 square, 6 Torx® bits; 3 magnetic nut setters and pouch. Wt. 0.93 lb.
009-82723.....49.99

Catalog/Online EXCLUSIVE
G. NEW Titan® 64-piece Power Bit Set. A broad selection of chrome vanadium bits for almost any application. Set includes 48 1-inch screwdriver bits, 15 2-inch screwdriver bits and a quick release 2-inch magnetic bit holder, all in a heavy-duty case. Wt. 1.95 lbs.
009-90142.....17.99

Catalog/Online EXCLUSIVE
H. NEW Titan® 48-piece Quick Disconnect Bit Set. Set includes countersink, magnetic extension and quick disconnect power nut drivers. 1-inch screwdriver bits include Phillips, slotted and hex. 2-inch quick disconnect bits include Torx®, Phillips, slotted, hex and high-speed drill. Includes blow-molded storage with two removable bit cases. Wt. 2 lbs.
009-90145.....14.99



E NEW

BOSCH

includes case and charger stand



F NEW

G NEW



H NEW

MORE TO EXPLORE
 at sears.com!

J NEW

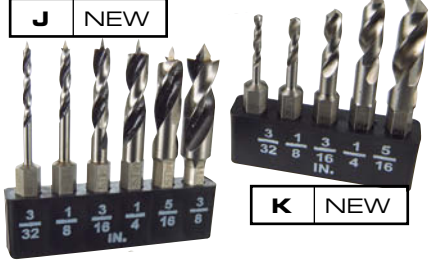

K NEW

Catalog/Online EXCLUSIVE
J. NEW Milecraft® StubbyBit™ 6-piece HSS Drill Bit Set for Wood. Short, one-piece, high-speed steel drill bits for drilling wood in confined spaces. 1/4-inch hex shaft, brad point tip. Wt. 0.35 lb.
009-82725.....19.99

Catalog/Online EXCLUSIVE
K. NEW Milecraft® StubbyBit™ 5-piece HSS Drill Bit Set for Metal/General Purpose. Short, one-piece, high-speed steel drill bits for drilling metal or other thin materials in confined spaces. 1/4-inch hex shaft, 135° standard tip. Wt. 0.35 lb.
009-82726.....14.99

CRAFTSMAN DRILLS – THE POWER DRIVES THE JOB

PORTABLE POWER TOOLS

L. Craftsman Professional 7.5-amp 1/2-inch Drill with Case. For those heavy-duty drilling jobs, the powerful variable-speed reversible 7.5-amp motor offers 0-850 rpm no-load. Features spindle lock, 1/2-inch keyless single sleeve metal chuck and built-in bubble level. Live tool indicator. Includes case and auxiliary handle. Wt. 9.7 lbs.
009-27161 109.99

1/2-INCH DRILLS



M. Craftsman 1/2-inch Drill. 6-amp motor provides the torque, power and durability for continuous drilling. Variable-speed 0-800 rpm no-load. Trigger switch with lock-on button. High-impact motor/gear housing protects the tool and reduces weight. Features ergonomic rear handle, live tool indicator, 1/2-in. single-sleeve keyless chuck and built-in level. Includes case.
Wt. 10.1 lbs.
009-10116 69.99

N. Craftsman 1/2-inch Drill. Drill has variable-speed 0-800 rpm no load, 5.5-amp, keyless chuck, bubble level and live tool indicator on overmolded handle. Includes auxiliary handle, 6-foot cord and case. Wt. 9.96 lbs.
009-10115 59.99



P. Craftsman 1/2-inch Hammer Drill. 6-amp motor with variable-speed 0-1,000 rpm no load and 0-16,000 bpm. 1/2-inch single sleeve keyless chuck. Change from drill to hammer by sliding switch. Spindle lock for easy bit changes. Live tool indicator in handle. Includes depth stop rod, auxiliary handle and case. Wt. 10.54 lbs.
009-10137 79.99

Q. Craftsman Professional 7.5-amp 1/2-inch Hammer Drill. Built to power through projects, the heavy-duty 7.5-amp motor provides high performance, with high/low speed for high-speed drilling or high torque applications. Variable speed delivers 0-1,000/0-2,700 rpm no-load and 0-19,000/0-46,000 bpm. Features dual hammer/drill modes, spindle lock, 1/2-inch keyless single sleeve metal chuck and built-in bubble level. Live tool indicator. Includes case, auxiliary handle and depth stop rod. Wt. 10.1 lbs.
009-26567 139.99



1/2-INCH HAMMER DRILLS



R. Craftsman Professional 8-amp 1/2-inch Hammer Drill. Variable-speed motor provides 0-2,800 rpm/0-44,800 bpm for powerful drilling and hammer force. Features a 1/2-in. chuck, lock-on power switch and live tool indicator. Includes blow-molded case, 360-degree auxiliary handle, depth gauge and chuck key. Warranted*. Wt. 11.4 lbs.
009-28129 119.99

S. Craftsman 3/8-inch Variable-Speed Corded Drill. 5-amp motor provides the torque, power and durability for continuous drilling. Variable-speed (0-1,500 rpm no-load). Trigger switch with lock-on button. Features a lighter weight high-impact motor/gear housing, ergonomically designed handle and permanently lubricated ball and sleeve bearings. Two built-in levels and case, 3/8 in. keyless chuck and live tool indicator on the handle. Wt. 5.84 lbs.
009-10107 39.99

U. Craftsman 3/8-inch Variable-Speed Corded Drill. 5.5-amp motor provides torque, power and durability. Variable speed (0-1,500 rpm no-load). Trigger switch with lock-on button and live tool indicator. Features a lighter weight high-impact motor/gear housing, ergonomically designed handle and permanently lubricated ball bearings. Bearing plate for added durability, 3/8 in. single-sleeve keyless chuck with spindle lock for easy bit changes, two built-in levels and case. Wt. 5.84 lbs.
009-10114 49.99

T. Craftsman Professional 3/8-inch Rear Handle Drill. The 6.5-amp motor provides the torque, power and durability for continuous drilling and driving. Variable-speed 0-2,500 rpm, with trigger switch with lock-on button, keyless chuck, live tool indicator and rear handle for positive grip, balance and comfort. Features built-in level and belt clip. Includes case. Wt. 9.44 lbs.
009-28126 59.99



3/8-INCH DRILLS

V. Craftsman Professional 7.5-amp 1/2-inch Square Drive Impact Wrench with Case. This variable-speed 1/2-inch impact driver delivers 1,200 no-load rpm/0 to 2,100 ipm. Built for durability, driver features 1/2-inch square drive with ball-pin retention system, die-cast gear case and ball-and-sleeve bearings for longevity. Features two-finger rocker switch, live tool indicator and accessible brushes. Includes case. Warranted*. Wt. 11.4 lbs.
009-27299 169.99

106-PIECE SET SPECIALTY DRILLS

W. Craftsman Professional 3/8-inch Mini T Drill. Fits into places that other drills can't – get work done between joists, inside cabinets and under decks. Powerful 3.2-amp motor develops 0-1,500 rpm no-load. Convenient one-hand reversing. 3/8-inch capacity keyed chuck. Cushioned, no-slip grip and insulated switch help dampen vibration. Ball-bearing construction. Includes molded carrying case. Warranted*. Wt. 5.54 lbs.
009-27996 139.99



*Warranted, see page 94a.
● See page 94a for laser use and precautions.

CRAFTSMAN[®]

20 VOLT LITHIUM-ION TOOL SETS

PROFESSIONAL

A
6-PIECE



Catalog/Online EXCLUSIVE
A Craftsman Professional 6-piece 20-volt Lithium-Ion Combo. Includes 1/2-inch drill/driver, 7 1/4-inch circular saw, reciprocating saw, jig saw, impact driver, LED worklight, two 20-volt lithium-ion batteries, 50-minute charger and contractor utility bag. The 20-volt lithium batteries use smart technology to monitor temperature, over charge and over discharge, protecting the battery from the three primary culprits of battery failure. A power bar on the battery displays the amount of charge remaining in the battery. Wt. 37 lbs.
 009-29029.....599.99

COMBO A INCLUDES
 professional-grade wheel around contractor bag

Catalog/Online EXCLUSIVE

B. NEW! SAVE OVER \$100 Ultimate Professional Drill Combo Kit. All the drilling, driving, hammering and impacting power you need in one impressive set. Drills are powered by 20-volt lithium-ion batteries featuring SmartChip[®] technology that battery maximizes run time and efficiency. 1/2-inch Variable-Speed Drill/driver with LED light delivers up to 500 in.-lbs. of torque, adjustable 24-position clutch, two-speed, all metal machined gear box. The 1/4-inch Impact Driver features quick-release collet, LED light, all-metal machined gear box. Delivers 0-2500 rpm, 1,200 in.-lbs. of maximum torque and 0-3,200 bpm. The 1/2-inch Hammer Drill/driver features single-sleeve chuck, adjustable 24 clutch settings, 2 speeds and an all-metal gearbox that delivers up to 500 in.-lbs. of torque. The 155-piece Speed Lok™ Ultimate Drill Bit Set includes 21 1/4-inch hex shank titanium coated bits, four wood boring bits, three masonry bits, compact screw guide, magnetic bit holder, 1/4-inch Speed-Lok connector, ratcheting screwdriver handle, Speed-Lok flex shaft, seven 3-in. power bits, 27 2-in. power bits, 73 1-in. insert bits, three nut setters, compact #12 drill and driver, one each 1/4-in. hex shank to 1/4 and 3/8-in. square drive adapter, three countersink inserts, three replacement bits, two set screws and storage bag. Separate prices total \$659.96.
 009-95900.....549.99

INCLUDES
 storage case for tools and mini case for 155 bits!

B NEW



8-PIECE

with 155-piece SPEED LOK™ Ultimate Drill Bit Set



BUILD A PERFECT PROFESSIONAL COMBO SET WITH ADD-ON TOOLS!

batteries sold separately

Craftsman Professional Lithium-Ion Tools

Item	Catalog No.	Description	Batteries	Wt., lbs.	Price
C.	009-28103	Worklight	Sold Separately	0.8	\$19.99
D.	009-26302	Cordless Drill	Sold Separately	3.9	79.99
E.	009-28128	Impact Driver	Sold Separately	4.2	79.99
F.	009-28127	Jig Saw	Sold Separately	3.8	69.99
G.	009-28102	Circular Saw	Sold Separately	7.7	89.99
H.	009-26314	Reciprocating Saw	Sold Separately	6.4	79.99
J.	009-25709	20-volt 50-minute SmartCharge System	Sold Separately	1.7	39.99
K.	009-25708	20-volt Battery Pak	1	1.6	89.99



CRAFTSMAN®

PORTABLE POWER TOOLS

includes two lithium-ion batteries and an AVANTI framing saw blade



BUY ONLINE
PICK-UP IN STORE!
 on eligible items

LITHIUM-ION TECHNOLOGY NOT ALL SAME -

With so many variations in lithium-ion chemistry, what ultimately has the most significant affect on lifecycle is the ability, through technology, to control the battery.

SMARTCHIP™ TECHNOLOGY

controls the THREE most harmful elements a battery can face

- OVER DISCHARGE** (output during use)
- OVER CHARGE** (input during charge cycle)
- EXTREME TEMPERATURE** (hot & cold)

LITHIUM-ION



M

Catalog/Online EXCLUSIVE
L. SAVE \$34.99 Craftsman Professional Lithium-Ion 20-volt 7 1/4-inch Circular Saw with Freud® Avanti Blade. Contractor-grade, lithium-ion 20-volt full-size 7 1/4 in. circular saw with LaserTrac™ and electric blade brake weighs only 9 lbs. (without blade). Job-rated motor delivers plenty of power to cut, rip or plunge through soft and hard woods alike. Heavy-duty all-metal machined gear box provides smooth, efficient power transfer to the blade. The saw is powered by a 20-volt lithium-ion DieHard® battery featuring SmartChip™ technology that maximizes the efficiency and life of the battery. Includes saw blades, two 20-volt lithium ion batteries, 50-minute charger and contractor utility bag. Warranted*. Regular separate prices total \$314.95. Wt. 15.3 lbs. ●
009-17199.....279.96

Catalog/Online EXCLUSIVE
M. Craftsman Professional 3-piece 20-volt Lithium-Ion Combo. Includes 1/2-inch drill/driver, 7 1/4-inch circular saw, adjustable 9-bulb LED worklight, two 20-volt lithium-ion batteries featuring SmartChip™ technology and a 50-minute charging system. Circular saw features LaserTrac™ cutting guide and integrated LED worklight for accurate cuts, as well as lightweight magnesium blade guards and an aluminum base. SmartChip™ maximizes run time and efficiency of the battery for more power and performance. Wt. 26.22 lbs. ●
009-26325.....399.99

N. Craftsman Professional 20-volt Lithium-Ion 1/2-inch Hammer Drill/Driver Kit. Features ratcheting all-metal, single-sleeve chuck, electric brake and 24 clutch settings. Variable-speed, (0-6,000) low (0-23,400) high bpm and (0-350) low (0-1,800) high rpm, heavy-duty all-metal gearbox delivers up to 500 in.-lbs. of torque. Lithium SmartChip™ technology maximizes the run time and efficiency of the battery. Comes with two lightweight lithium-ion batteries, a 50-minute charger and contractor grade utility bag. Warranted*. Wt. 12 lbs.
009-29015.....289.99



N

Q. Craftsman 16-volt Lithium-Ion 3/8-in. Drill/Driver Combo. Combo includes a double-ended bit, one 3/8-in. lightweight, compact drill/driver with 320 in.-lbs. of maximum torque and variable-speed switch (0-280 rpm and 0-1,200 rpm no-load), 24-position torque clutch and "blue" LED that shines directly on bit for confidence; one LED swivel worklight; two 16-volt DieHard® lithium-ion slim batteries that are 37% lighter than NiCad and feature SmartChip™ technology to protect from over charge/discharge and extreme temperatures; a 60-minute charger/adaptor with a two LED/four-light charge indicator; and a carry bag. Warranted*. Wt. 10.5 lbs.
009-11820.....139.99

*Warranted, see page 94a.
 ● See "N" suffix note on page 94a.
 ● See page 88a for laser use and precautions.



WOOD OWL

Catalog/Online EXCLUSIVE
P. NEW Wood Owl® OverDrive™ Cordless Drill Bits. Designed for cordless drills, OverDrive™ bits reduce fatigue and extend battery life. Brad point tip and chamfered lead-in edge for fast, on-target starts. Hardened steel construction and precision machining ensure durability and accuracy.

Wood Owl® Overdrive™ Bits

Item	Model	Description	Dia.	Wt./lbs.	Price
009-89193	00700	OverDrive™ Bits	1/2-in.	0.2	\$8.99
009-89194	00701	OverDrive™ Bits	5/8-in.*	0.22	9.99
009-89195	00702	OverDrive™ Bits	3/4-in.*	0.26	10.99
009-89196	00703	OverDrive™ Bits	7/8-in.	0.33	12.99
009-89197	00704	OverDrive™ Bits	1-in.*	0.37	15.99
009-89198	00705	OverDrive™ Bits	1-1/4-in.	0.23	17.99
009-89199	00706	OverDrive™ 6-pc. Set	6-pc. Kit	2.65	59.99
009-89206	00707	OverDrive™ 3-pc. Set	3-pc. Kit	1.8	24.99

*Included in 3-pc. set.



Q

16-VOLT COMBO

ALL NEW

CRAFTSMAN®

C3 | CORDLESS SYSTEM

MULTIPLE TOOLS POWERED BY ONE 19.2V DIEHARD® BATTERY

NOW **30** CRAFTSMAN TOOLS POWERED BY ONE 19.2 DIEHARD® BATTERY! AND MORE TO COME!

THE BATTERY



pushbutton fuel gauge indicates battery charge level

LITHIUM ION Our Best Power Source

- Over 295% better performance than Ni-CAD batteries
- 40% longer shelf life than Ni-CAD batteries
- 20% lighter weight than Ni-CAD batteries
- On-board energy indicator

green – fully charged, yellow – 50% charge, red – time to recharge



19.2V C3 DRILL DRIVER

includes tool bag



19.2V C3 CAULK GUN

A. NEW Craftsman C3 19.2-volt 1/2-inch Drill/Driver with Bag. Two-speed delivers up to 410 in.-lbs. of torque. Two-sleeve keyless chuck for quick bit changes. Features bubble level, 24-position clutch, electric brake and bit storage. Includes two DieHard batteries, charger, 2 double-end and bag. Wt. 10.5 lbs. 009-11588 119.99

B. NEW Craftsman C3 19.2-volt Caulk Gun Ideal for any larger caulking projects, the variable speed gun lets you adjust the discharge rate. The all-metal plunger delivers over 500 pounds of force. Runs on any C3 19.2 DieHard battery. Wt. 4.8 lbs. 009-11596 39.99

C. NEW Craftsman C3 19.2-volt Orbital Buffer/Polisher. Barrel grip body and large handle for comfortable operation at any angle. Provides swirl-free finish. Side-switch. Includes buffer/polisher and bonnet. Wt. 4.5 lbs. 009-11597 34.99

D. NEW Craftsman C3 19.2-volt Spot Light. Produces 8,000 LUX brightness to illuminate large work areas. Durable, impact-resistant shell provides added protection. Lock-on button for hands-free operation. Wt. 2.63 lbs. 009-11593 24.99

19.2V C3 BUFFER POLISHER



CUSTOMER review

It has all the torque that I will ever need in my home projects.

LakeRat
Logan County, OH

19.2V C3 SPOT LIGHT



SEE THE COMPLETE C3 SYSTEM AT CRAFTSMAN.COM/C3

ULTIMATE C3 COMBO KIT!

PORTABLE POWER TOOLS



Create your own power tool combo! See the C3 system in action at craftsman.com/c3

TONY'S PICK



Mega C3 Power Tool Combo

Item #	Description	Reg. Sep.
009-11581	Drill Driver	49.99
009-11580	Hammer Drill	74.99
009-11585	7 1/4 in. Circular Saw	109.99
009-11579	Reciprocating Saw	59.99
009-11569	Laser Jig Saw	59.99
009-11576	Right Angle Drill	69.99
009-11483	Impact Driver	74.99
009-11582	Cut-Out Saw	49.99
009-11570	Pad Sander	29.99
009-11571	Hand Vac	24.99
009-10126	Radio	29.99
009-11592	Workshop Blower/Vac	39.99
009-11583	Trim Router	59.99
009-11584	Planer	74.99
009-11577	Nailer/Stapler	74.99
009-11586	Inflator	44.99
009-11407	Fluorescent Light	16.99
009-11375	Batteries (4)	139.99
009-11573	Dual-port Charger	34.99
009-90225	Rollaway case	64.99
009-74992	Soft Side Bag (2)	39.99
Total of all Tools		\$1,226.75

SAVE OVER \$225

Catalog/Online EXCLUSIVE

E. SAVE OVER \$225
Craftsman 17-piece C3 19.2-volt Mega Combo Kit. A heavy-duty workshop packaged into one extraordinary kit. Comes with all the basic power tools you'll need and then some. This kit offers all the cutting, drilling, driving, ripping, sanding and illuminating power you'll need to tackle all your projects. Comes with four DieHard 19.2-volt batteries plus a dual charger so you'll always be ready to work. Rolling storage and soft-sided tool bags let you take the tools wherever you need them. Separate prices total \$1,226.75. Warranted*. Wt. 114.6 lbs.
 009-11517999.99

BEST VALUE

SAVE OVER \$225



Craftsman storage included—1 rollaway and 2 soft side bags

Catalog/Online EXCLUSIVE Craftsman Deluxe Combo

Item #	Description	Reg. Sep.
009-11581	Drill Driver	49.99
009-11483	Impact Driver	74.99
009-11585	7 1/4" Circular Saw	109.99
009-11574	Reciprocating Saw	59.99
009-11569	Laser Jig Saw	59.99
009-11576	Right Angle Drill	69.99
009-11582	Cut-Out Saw	49.99
009-11570	Pad Sander	29.99
009-11571	Hand Vac	24.99
009-11407	Fluorescent Light	16.99
009-11391	Work Light	14.99
009-11375	Batteries (3)	104.97
009-11573	Dual-Port Charger	34.99
009-90225	Craftsman Rollaway	64.99
009-74992	Craftsman Soft Bag	19.99
Total of All Tools		\$786.83

SAVE \$206.84!

F. SAVE 259.96

Craftsman C3 19.2-volt 11-piece Combo Kit with Rolling Storage Case and Bag. Combo includes 1/2-inch drill/driver with a 24-position adjustable clutch, 7 1/4-inch circular saw with front and rear lasers, reciprocating saw, jig saw with laser guide, right-angle drill, sander, cut-out saw with circle attachment, impact driver, hand vac, pivoting head flashlight, fluorescent light, rolling case, storage bag, three battery packs and dual port charger. Warranted*. Wt. 86 lbs.
 009-17189579.99

*Warranted, see page 94a.
 ♦ See "N" suffix note on page 94a.
 ● See page 88a for laser use and precautions.



COMBOS POWERED WITH DIEHARD®

CRAFTSMAN[®]

P R O F E S S I O N A L

NEW 8-Piece 20-Volt Lithium-Ion Ultimate Drill Combo Kit

**ALL THE DRILLING,
DRIVING, HAMMERING
AND IMPACTING POWER YOU
NEED IN ONE IMPRESSIVE SET!**

see page 192 for details.

Sears

8374 North 4000 East Rd., Manteno, IL 60950

Shop sears.com/shoptools,
visit your local Sears store
or call 800-377-7414.

PSRT STD
U.S. POSTAGE
PAID
SEARS

Or Current Resident

Use this code to place your order today!

Visit sears.com to find the
Sears store near you.

A1



ORDER THRU APRIL 30, 2010

SEARS.COM/SHOPTOOLS
800.377.7414



Together, we can improve the sustainable use of natural resources. Please recycle your Sears catalog. Contact your local municipality for recycling guidelines. Cover printed on recycled paper containing a minimum of 10% post-consumer material.

ULTIMATE C3 COMBO KIT!

PORTABLE POWER TOOLS



Create your own power tool combo! See the C3 system in action at craftsman.com/c3

TONY'S PICK

Mega C3 Power Tool Combo

Item #	Description	Reg. Sep.
009-11581	Drill Driver	49.99
009-11580	Hammer Drill	74.99
009-11585	7 1/4 in. Circular Saw	109.99
009-11579	Reciprocating Saw	59.99
009-11569	Laser Jig Saw	59.99
009-11576	Right Angle Drill	69.99
009-11483	Impact Driver	74.99
009-11582	Cut-Out Saw	49.99
009-11570	Pad Sander	29.99
009-11571	Hand Vac	24.99
009-10126	Radio	29.99
009-11592	Workshop Blower/Vac	39.99
009-11583	Trim Router	59.99
009-11584	Planer	74.99
009-11577	Nailer/Stapler	74.99
009-11586	Inflator	44.99
009-11407	Fluorescent Light	16.99
009-11375	Batteries (4)	139.99
009-11573	Dual-port Charger	34.99
009-90225	Rollaway case	64.99
009-74992	Soft Side Bag (2)	39.99
Total of all Tools		\$1,226.75

SAVE OVER \$225



BEST VALUE

SAVE OVER \$225

Catalog/Online EXCLUSIVE

E. SAVE OVER \$225

Craftsman 17-piece C3 19.2-volt Mega Combo Kit. A heavy-duty workshop packaged into one extraordinary kit. Comes with all the basic power tools you'll need and then some. This kit offers all the cutting, drilling, driving, ripping, sanding and illuminating power you'll need to tackle all your projects. Comes with four DieHard 19.2-volt batteries plus a dual charger so you'll always be ready to work. Rolling storage and soft-sided tool bags let you take the tools wherever you need them. Separate prices total \$1,226.75. Warranted*. Wt. 114.6 lbs.

009-11517 999.99



Craftsman storage included—1 rollaway and 2 soft side bags

Catalog/Online EXCLUSIVE

Craftsman Deluxe Combo

Item #	Description	Reg. Sep.
009-11581	Drill Driver	49.99
009-11483	Impact Driver	74.99
009-11585	7 1/4" Circular Saw	109.99
009-11574	Reciprocating Saw	59.99
009-11569	Laser Jig Saw	59.99
009-11576	Right Angle Drill	69.99
009-11582	Cut-Out Saw	49.99
009-11570	Pad Sander	29.99
009-11571	Hand Vac	24.99
009-11407	Fluorescent Light	16.99
009-11391	Work Light	14.99
009-11375	Batteries (3)	104.97
009-11573	Dual-Port Charger	34.99
009-90225	Craftsman Rollaway	64.99
009-74992	Craftsman Soft Bag	19.99
Total of All Tools		\$786.83

SAVE \$206.84!

F. SAVE 259.96

Craftsman C3 19.2-volt 11-piece Combo Kit with Rolling Storage Case and Bag. Combo includes 1/2-inch drill/driver with a 24-position adjustable clutch, 7 1/4-inch circular saw with front and rear lasers, reciprocating saw, jig saw with laser guide, right-angle drill, sander, cut-out saw with circle attachment, impact driver, hand vac, pivoting head flashlight, fluorescent light, rolling case, storage bag, three battery packs and dual port charger. Warranted*. Wt. 86 lbs. ●

009-17189 579.99

*Warranted, see page 94a.

● See "N" suffix note on page 94a.

● See page 88a for laser use and precautions.



CRAFTSMAN[®]

NEW 8-Piece 20-Volt Lithium-Ion Ultimate Drill Combo Kit

**ALL THE DRILLING,
DRIVING, HAMMERING
AND IMPACTING POWER YOU
NEED IN ONE IMPRESSIVE SET!**

see page 192 for details.

Sears

8374 North 4000 East Rd., Manteno, IL 60950

Shop sears.com/shoptools,
visit your local Sears store
or call 800-377-7414.

PSRST STD
U.S. POSTAGE
PAID
SEARS

Or Current Resident

Use this code to place your order today!



Visit sears.com to find the
Sears store near you.

A1



ORDER THRU APRIL 30, 2010

SEARS.COM/SHOPTOOLS
800.377.7414



Together, we can improve the sustainable use of natural resources. Please recycle your Sears catalog. Contact your local municipality for recycling guidelines. Cover printed on recycled paper containing a minimum of 10% post-consumer material.